

interhome

Separating Wall System for Low-rise
Multi-Residential Construction

Disclaimer

Products manufactured and construction systems designed by Etex Australia Pty Ltd and branded Siniat, are produced in accordance with the Building Code of Australia and relevant Australian Standards. Information in this document is to be used as a guide only and is subject to project approval as many aspects of construction are not comprehensively covered. It is the responsibility of the project to determine if our products, construction systems and installation details are suitable for the intended application and they meet the relevant building codes and project requirements. It is also the project's responsibility to ensure third party products have the appropriate certification for use with Siniat products and construction systems. Etex Australia Pty Ltd will not be held responsible for any claims resulting from the installation of Siniat products or other associated products not in accordance with the requirements of the manufacturer's technical literature or relevant Australian Standards, or for situations not covered by our certification reports.

Siniat technical information is regularly updated. To ensure this document is current with the latest information, visit siniat.com.au or contact Siniat Customer Service Centre on **1300 724 505**

Warranty

Siniat products are guaranteed by a 10 Year Warranty.

Visit siniat.com.au/warranty

Version 14

October 2024

About Siniat

Siniat is one of the Etex Group's flagship commercial brands, and one of the leading global manufacturers of interior and exterior materials for drywall construction.

In Australia, Etex has Siniat manufacturing facilities located in Sydney, Melbourne, Bundaberg and Brisbane. Etex supplies Siniat branded plasterboard, compounds, cornice, steel profiles and associated products and systems to the Australian building industry through its national distribution network.

Siniat's comprehensive range of quality wall and ceiling lining products are developed with specific characteristics to enhance performance and provide fire, water, acoustic and decorative solutions to all construction projects.

The Siniat team is committed to providing excellent technical service and sales support to help with innovative solutions for your next project.

Download Siniat Documents



Contents

INTRODUCTION	4
Features Summary	4
Applications	4
1 FEATURES	5
2 BENEFITS	6
3 PERFORMANCE	7
Structural Performance	7
Water Resistance	7
Fire Resistance	7
Acoustic Performance	7
Weather Protection	7
4.1 TIMBER SYSTEMS	8
4.2 STEEL SYSTEMS	12
4.3 CEILING ATTENUATION CLASS SYSTEMS	15
5 INSTALLATION	18
Components	18
General Requirements	19
Fire Resistance	19
Sound Insulation	20
Framing	20
Plasterboard Layout	24
Plasterboard Fixing	24
Intershield and Multishield	24
Weather Protection of Central Fire Barrier	25
Services and Penetrations	25
6 DETAILS	28
7 CHECK LIST	65



Introduction

This **interhome** systems and installation guide is suitable for load bearing walls with an FRL of 60/60/60 supporting non-fire rated floors and roofs. These **interhome** walls start at a concrete slab or other fire rated support and finish under a roof.

Features Summary

- > Fire Resistance Level (FRL) 60/60/60*
- > Sound insulation performance for separating walls of: $R_w + C_{tr} 50 + \text{Discontinuous Construction}$
- > Sound insulation performance for soil and waste pipes of: $R_w + C_{tr} 25$ and $R_w + C_{tr} 40$
- > Provisions for installation in wet areas.

Applications

- > Dividing Class 1 buildings such as duplexes or townhouses
- > Dividing Class 1 buildings from Class 10a
- > Walls separating SOUs (Sole Occupancy Units) on the top floor of a Class 2 or 3 building
- > Walls separating units of a class 2 building with Type B construction in which SOUs are not separated by fire rated floors*
- > Walls in other building classes in which **interhome** walls meet the FRL and sound insulation requirements.*

Refer to Siniat Blueprint for axially non-load bearing **interhome high-rise** wall systems suited to concrete slab-to-slab construction and for ceiling treatment options on the top floor of a Class 2 building with a framed roof.

Refer to the **interhome** FRL 90/90/90 Supplement for load bearing **interhome** systems for Class 2 Type A buildings where the wall starts at the ground, slab or other fire rated support and finishes under a roof.

* WARNING. This **interhome** installation guide is not suitable in timber or steel framed multi-residential buildings whereby sole occupancy units are located above and below each other and they are separated by a timber or steel framed floor that requires a fire rating.

Features

There are 4 specific design elements that set **interhome** apart from conventional separating wall systems.

1. A central fire barrier supported by aluminium clips

interhome differs from a conventional twin frame separating wall as it contains a central fire barrier built between timber or steel house frames.

The central fire barrier is:

- > Composed of 25mm **shaftliner** or **intershield**
- > The **shaftliner** or **intershield** is encased in **interhome** H-Studs spaced at 600mm centres
- > Structurally supported by **interhome aluminium clips** to the two stud frames.

The central fire barrier limits the spread of fire from one dwelling to adjoining dwellings.

[Refer to Figure 1]

shaftliner is a fire resistant plasterboard.

intershield is a fire, water and mould resistant plasterboard and is recommended for weather protection during construction.

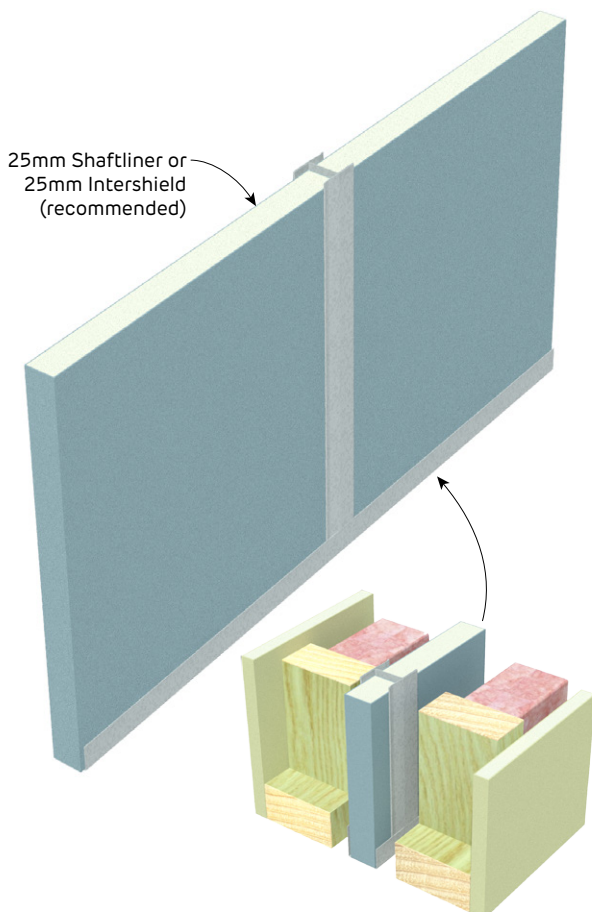

FIGURE 1 Central Fire Barrier

interhome aluminium clips are used to structurally support the central fire barrier and are purposely made from aluminium. They are designed to melt in a fire, so the frame of the dwelling exposed to the fire can detach from the central fire barrier. The dwelling affected by the fire may therefore degrade, and even collapse without spreading the fire to the adjoining dwelling.

2. Laminating method for protecting floor junctions and roof cavities

The laminating method is an important feature of **interhome** fire protection of floor junctions and roof cavities. It prevents complicated conventional construction methods where fire rated plasterboard has to be fixed to timber trusses or secondary wall frames built above ceiling level.

3. Integrated services and penetrations

interhome is an easier solution when it comes to installing penetrations for electrical and plumbing services. With masonry and conventionally framed separating walls, incorporation of services like electrical cables, power-points and plumbing pipes is always a difficulty. Maintaining the fire protection and sound insulation performance in these cases can be an issue. These conventional systems are time consuming to install and are difficult to inspect once completed.

interhome uses the central fire barrier to maintain fire protection and sound insulation performance. Services may run through the wall cavity [Figure 2] and penetrations [Figure 3] may be made in the outer layers of plasterboard without the need for fire baffles in the cavity. There is no requirement for fire rated power-point boxes and fire collars around PVC pipes.*

In addition, installation of back-to-back services has been verified in the fire and acoustic testing conducted on **interhome**, without degrading performance.

*Service penetrations in the central fire barrier are recommended to be installed in the roof space for acoustic reasons. They must be in accordance with a certified detail or NCC Volume One Section 3.7.1.8.

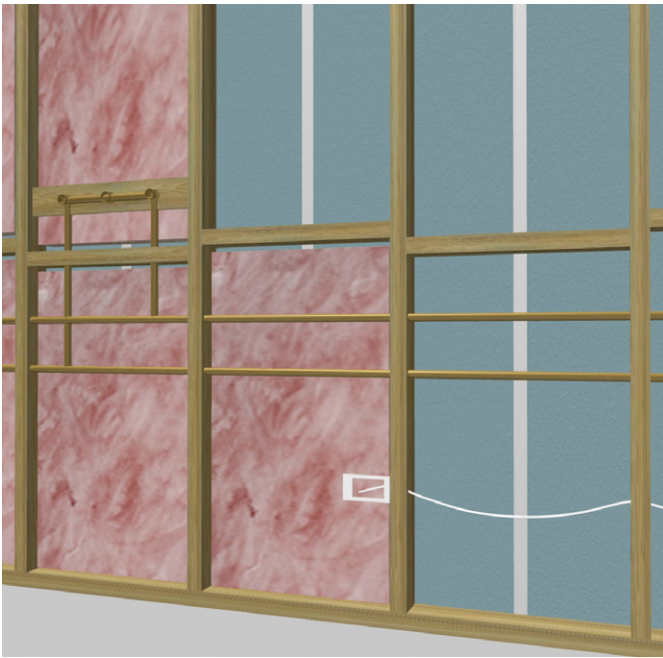

FIGURE 2 Services Installed in the Wall Cavity



FIGURE 3 Services with Outer Layer of Plasterboard Installed

Benefits

interhome has been designed as a superior solution over masonry, conventional twin frame separating walls and other party wall systems.

Saves time through a modular construction method

- > The central fire barrier is built during the construction of the timber wall frame in 3 or 3.6 metre high modular sections, and can be installed by the carpenter
- > There is no requirement for the central fire barrier to be jointed with compounds
- > The outer layers of plasterboard are installed to non-fire rated installation methods
- > The co-ordination between trades is smoother.

Simple and safe for builders and contractors

- > Hassle-free installation of penetrations and services
- > A low risk solution for easier certification.

4. Non-fire rated installation of outer wall linings

The outer layers of all **interhome** systems are installed using non-fire rated installation techniques. The internal linings contribute to the fire and acoustic performance of the system.



Performance

Structural Performance

For safety reasons the **interhome** central fire barrier must be adequately propped until the dwelling is enclosed for wind loading purposes. **interhome aluminium clips** joining the timber/steel frame to the **interhome H-stud** must be installed at the same time as the central fire barrier for structural stability.

Timber framed **interhome** systems must be designed to Australian Standard AS1684 'Residential timber-framed construction' or AS1720 'Timber structures'. Timber studs must be 70mm minimum in depth.

Steel framed **interhome** systems must be designed to Australian Standard AS4600 'Cold-formed steel structures', AS4100 'Steel structures' or NASH Standard for Residential and Low-rise Steel Framing Part 1 and Part 2.

Any axial load contribution of the plasterboard lining to either the timber or steel framed systems is not permitted.

The load bearing capacity of **interhome** is maintained for the designated FRL of the timber or steel frame opposite to fire attack.

Maximum Wall Height Table

Aluminium Clip Maximum Spacing (m)	Maximum Wall Height (m)
2.7	14.0
3.0	12.0
3.2	10.8
3.6	9.0

Water Resistance

There are several **interhome** systems available for wet areas (bathroom, toilet or laundry). Consult the latest Siniat Plasterboard Installation Guide on the website for installation, waterproofing and finishing of plasterboard in these areas.

Fire Resistance

interhome systems meet the Fire Resistance requirements of the NCC as certified by an Accredited Fire Testing Laboratory. The systems have been tested and/or assessed to AS1530.4 'Methods for fire tests on building materials, components and structures – Fire resistance test of elements of construction'.

The internal lining and insulation of any **interhome** system can be used on one side of a different **interhome** system without reducing its FRL.

Acoustic Performance

Acoustic performance has been determined by either laboratory testing at CSIRO, Marshall Day Insul software, or calculated based on laboratory testing.

In most cases, site acoustic performance of installed systems is lower than those measured in the laboratory due to the transmission of sound via flanking paths. Siniat cannot guarantee on-site acoustic performance and where performance is critical, recommends consulting acoustical engineers.

When the internal lining and insulation of one **interhome** system is used on one side of a different **interhome** system the acoustic rating is the lower of the two provided that the central fire barrier and stud cavity sizes are the same.

i To minimise sound flanking paths, seal the perimeter with **bindex fire and acoustic sealant** to maintain acoustic integrity. Services in the wall cavities must not come into contact with the central fire barrier.

Other site conditions like sound transmitting through windows and other walls may also be detrimental to the final acoustic rating.

Installing the **interhome aluminium clips** in zones other than those shown in the Details may result in the wall not meeting NCC 'discontinuous construction' requirements.

Weather Protection

During construction, **interhome** may be exposed to the weather. Protect plasterboard in the central fire barrier from water and excessive moisture until the dwelling is enclosed. This is to prevent mould growth and degradation of the plasterboard.

A suitable impervious covering like plastic sheeting must be used to protect the central fire barrier in adverse weather conditions. Plastic sheeting can be stapled to the central fire barrier or attached to the dwellings frame.

Pay particular attention to protecting the base of the central fire barrier where water may pool between timber bottom plates or steel tracks. The plastic sheeting must deflect any water from pooling at the base.

Only install internal linings after the dwelling is completely enclosed and weather protected.

i If the plasterboard in the central fire barrier is likely to be wet before covering, then a spray application of a non-flammable waterproof/repellent sealer can be used. The plasterboard must be completely dry before enclosing the wall cavity.



Timber Systems

IHW1		<ul style="list-style-type: none"> • 10mm soundshield or opal • Timber stud framing with insulation • Minimum 20mm air-gap • 25mm shaftliner or intershield encased in interhome H-studs • Minimum 20mm air-gap • Timber stud framing with insulation • 10mm soundshield or opal 		Fire Resistance Level 60/60/60 rated for the wall frame opposite to fire attack Fire Report FC11661		
	Minimum Cavity On Each Side (mm)	Wall Width (mm)	Sound Insulation Rw (Rw + Ctr)			
	Cavity size = stud size + air-gap		2 x Pink® Batts R2.5 HD			Acoustic Report Day Design 3094-42 Note: Impact Sound Resistant - Discontinuous Construction
	110 (eg: 70 stud + 40 gap or 90 stud + 20 gap)	265	64 (50)			

IHW2		<ul style="list-style-type: none"> • 13mm soundshield or trurock • Timber stud framing with insulation • Minimum 20mm air-gap • 25mm shaftliner or intershield encased in interhome H-studs • Minimum 20mm air-gap • Timber stud framing with insulation • 13mm soundshield or trurock 				Fire Resistance Level 60/60/60 rated for the wall frame opposite to fire attack Fire Report FC11661	
	Minimum Cavity On Each Side (mm)	Wall Width (mm)	Sound Insulation Rw (Rw + Ctr)				
	Cavity size = stud size + air-gap		2 x Pink® Batts Wall R2.0	2 x Pink® Batts Wall R2.5 HD	2 x Polyester R1.5	2 x Polyester R2.0	Acoustic Report Day Design 3094-42 Note: Impact Sound Resistant - Discontinuous Construction
	90 (eg: 70 stud + 20 gap)	231	67 (52)	68 (53)	65 (50)	64 (51)	
110 (eg: 90 stud + 20 gap)	271	67 (55)	69 (56)	66 (51)	65 (53)		

IHW4		<ul style="list-style-type: none"> • 13mm watershield • Timber stud framing with insulation • Minimum 20mm air-gap • 25mm shaftliner or intershield encased in interhome H-studs • Minimum 20mm air-gap • Timber stud framing with insulation • 13mm watershield 			Fire Resistance Level 60/60/60 rated for the wall frame opposite to fire attack Fire Report FC11661	
	Minimum Cavity On Each Side (mm)	Wall Width (mm)	Sound Insulation Rw (Rw + Ctr)			
	Cavity size = stud size + air-gap		2 x Pink® Batts Wall R2.0 HD	2 x Pink® Batts Wall R2.5 HD	2 x Polyester R2.0	Acoustic Report Day Design 3094-42 Note: Impact Sound Resistant - Discontinuous Construction
	90 (eg: 70 stud + 20 gap)	231	-	65 (50)	-	
110 (eg: 90 stud + 20 gap)	271	61 (51)	66 (51)	63 (50)		

IHW5		<ul style="list-style-type: none"> • 6mm Villaboard™ • Timber stud framing with insulation • Minimum 20mm air-gap • 25mm shaftliner or intershield encased in interhome H-studs • Minimum 20mm air-gap • Timber stud framing with insulation • 6mm Villaboard™ 			Fire Resistance Level 60/60/60 rated for the wall frame opposite to fire attack Fire Report FC11661	
	Minimum Cavity On Each Side (mm)	Wall Width (mm)	Sound Insulation Rw (Rw + Ctr)			
	Cavity size = stud size + air-gap		2 x Pink® Batts Wall R2.0 HD	2 x Pink® Batts R2.5	2 x Pink® Batts Wall R2.5 HD	Acoustic Report Day Design 3094-20 3094-42 Note: Impact Sound Resistant - Discontinuous Construction
	90 (eg: 70 stud + 20 gap)	217	-	-	65 (50)	
110 (eg: 90 stud + 20 gap)	257	65 (50)	65 (50)	67 (51)		



IHW6

- 13mm **fireshield** or **multishield**
- Timber stud framing with insulation
- Minimum 20mm air-gap
- 25mm **shaftliner** or **intershield** encased in **interhome H-studs**
- Minimum 20mm air-gap
- Timber stud framing with insulation
- 13mm **fireshield** or **multishield**

Fire Resistance Level

60/60/60
rated for the wall frame opposite to fire attack

Fire Report FC11661

Minimum Cavity On Each Side (mm)	Wall Width (mm)	Sound Insulation Rw (Rw + Ctr)			
Cavity size = stud size + air-gap		2 x Pink® Batts Wall R2.0	2 x Pink® Batts Wall R2.0 HD	2 x Pink® Batts Wall R2.5 HD	2 x Polyester R2.0
90 (eg: 70 stud + 20 gap)	231	-	65 (50)	65 (50)	-
110 (eg: 90 stud + 20 gap)	271	64 (50)	66 (51)	66 (51)	65 (50)

Acoustic Report Day Design 3094-42 3094-20
Note: Impact Sound Resistant - Discontinuous Construction

IHW8

- 2 layers of 10mm **mastashield** or **watershield**
- Timber stud framing with insulation
- Minimum 20mm air-gap
- 25mm **shaftliner** or **intershield** encased in **interhome H-studs**
- Minimum 20mm air-gap
- Timber stud framing with insulation
- 2 layers of 10mm **mastashield** or **watershield**

Fire Resistance Level

60/60/60
rated for the wall frame opposite to fire attack

Fire Report FC11661

Minimum Cavity On Each Side (mm)	Wall Width (mm)	Sound Insulation Rw (Rw + Ctr)			
Cavity size = stud size + air-gap		2 x Pink® Batts Wall R2.0	2 x Pink® Batts Wall R2.5 HD	2 x Polyester R1.5	2 x Polyester R2.0
90 (eg: 70 stud + 20 gap)	245	66 (51)	68 (52)	-	-
110 (eg: 90 stud + 20 gap)	285	68 (53)	69 (54)	63 (50)	65 (51)

Acoustic Report Day Design 3094-42
Note: Impact Sound Resistant - Discontinuous Construction

IHW16

- 10mm **mastashield** or **watershield**
- Timber stud framing with insulation
- Minimum 20mm air-gap
- 25mm **shaftliner** or **intershield** encased in **interhome H-studs**
- Minimum 20mm air-gap
- Timber stud framing with insulation
- 2 layers of 10mm **mastashield** or **watershield**

Fire Resistance Level

60/60/60
rated for the wall frame opposite to fire attack

Fire Report FC11661

Minimum Cavity On Each Side (mm)	Wall Width (mm)	Sound Insulation Rw (Rw + Ctr)	
Cavity size = stud size + air-gap		2 x Pink® Batts Wall R2.5 HD	
110 (eg: 70 stud + 40 gap or 90 stud + 20 gap)	275	64 (50)	

Acoustic Report Day Design 5008-7
Note: Impact Sound Resistant - Discontinuous Construction

IHW17

- 13mm **mastashield** or **watershield**
- Timber stud framing with insulation
- Minimum 20mm air-gap
- 25mm **shaftliner** or **intershield** encased in **interhome H-studs**
- Minimum 20mm air-gap
- Timber stud framing with insulation
- 2 layers of 13mm **mastashield** or **watershield**

Fire Resistance Level

60/60/60
rated for the wall frame opposite to fire attack

Fire Report FC11661

Minimum Cavity On Each Side (mm)	Wall Width (mm)	Sound Insulation Rw (Rw + Ctr)	
Cavity size = stud size + air-gap		2 x Pink® Batts Wall R2.0	
90 (eg: 70 stud + 20 gap)	244	66 (53)	
110 (eg: 90 stud + 20 gap)	284	66 (53)	

Acoustic Report Day Design 5008-7
Note: Impact Sound Resistant - Discontinuous Construction



IHW18				Fire Resistance Level	
	<ul style="list-style-type: none"> • 10mm soundshield or opal • Timber stud framing with insulation • Minimum 20mm air-gap • 25mm shaftliner or intershield encased in interhome H-studs • Minimum 20mm air-gap • Timber stud framing with insulation • 2 layers of 10mm mastashield or watershield 			60/60/60 rated for the wall frame opposite to fire attack Fire Report FC11661	
	Minimum Cavity On Each Side (mm)	Wall Width (mm)	Sound Insulation Rw (Rw + Ctr)		
	Cavity size = stud size + air-gap		2 x Pink® Batts Wall R2.0		
	90 (eg: 70 stud + 20 gap)	235	66 (50)		
110 (eg: 90 stud + 20 gap)	275	66 (51)			
				Acoustic Report Day Design 5008-7 Note: Impact Sound Resistant - Discontinuous Construction	

IHW40				Fire Resistance Level	
	<ul style="list-style-type: none"> • 13mm mastashield • Timber stud framing with insulation • Minimum 20mm air-gap • 25mm shaftliner or intershield encased in interhome H-studs • Minimum 20mm air-gap • Timber stud framing with insulation • 13mm mastashield 			60/60/60 rated for the wall frame opposite to fire attack Fire Report FC11661	
	Minimum Cavity On Each Side (mm)	Wall Width (mm)	Sound Insulation Rw (Rw + Ctr)		
	Cavity size = stud size + air-gap		2 x Pink® Batts Wall R2.0		
	110 (eg: 70 stud + 40 gap or 90 stud + 20 gap)	271	65 (50)		
				INSUL v8 Acoustic Prediction Note: Impact Sound Resistant - Discontinuous Construction	

IHW41				Fire Resistance Level	
	<ul style="list-style-type: none"> • 13mm mastashield • Timber stud framing with insulation • Minimum 20mm air-gap • 25mm shaftliner or intershield encased in interhome H-studs • Minimum 20mm air-gap • Timber stud framing with insulation • 13mm watershield 			60/60/60 rated for the wall frame opposite to fire attack Fire Report FC11661	
	Minimum Cavity On Each Side (mm)	Wall Width (mm)	Sound Insulation Rw (Rw + Ctr)		
	Cavity size = stud size + air-gap		2 x Pink® Batts Wall R2.0		
	110 (eg: 70 stud + 40 gap or 90 stud + 20 gap)	271	66 (52)		
				INSUL v8 Acoustic Prediction Note: Impact Sound Resistant - Discontinuous Construction	

IHW42				Fire Resistance Level	
	<ul style="list-style-type: none"> • 13mm mastashield or watershield • Timber stud framing with insulation • Minimum 20mm air-gap • 25mm shaftliner or intershield encased in interhome H-studs • Minimum 20mm air-gap • Timber stud framing with insulation • 6mm Villaboard™ 			60/60/60 rated for the wall frame opposite to fire attack Fire Report FC11661	
	Minimum Cavity On Each Side (mm)	Wall Width (mm)	Sound Insulation Rw (Rw + Ctr)		
	Cavity size = stud size + air-gap		2 x Pink® Batts Wall R2.0		
	110 (eg: 70 stud + 40 gap or 90 stud + 20 gap)	264	65 (51)		
				INSUL v8 Acoustic Prediction Note: Impact Sound Resistant - Discontinuous Construction	

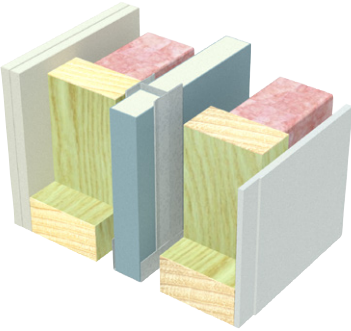

IHW43				Fire Resistance Level
	<ul style="list-style-type: none"> 2 layers of 10mm mastashield or watershield Timber stud framing with insulation Minimum 20mm air-gap 25mm shaftliner or intershield encased in interhome H-studs Minimum 20mm air-gap Timber stud framing with insulation 6mm Villaboard™ 			<p>60/60/60 rated for the wall frame opposite to fire attack</p> <p>Fire Report FC11661</p>
	Minimum Cavity On Each Side (mm)	Wall Width (mm)	Sound Insulation Rw (Rw + Ctr)	
	Cavity size = stud size + air-gap 110 (eg: 70 stud + 40 gap or 90 stud + 20 gap)	271	2 x Pink® Batts Wall R2.0 69 (54)	
			INSUL v8 Acoustic Prediction Note: Impact Sound Resistant - Discontinuous Construction	



Steel Systems

IHW9		<ul style="list-style-type: none"> • 10mm soundshield or opal • Steel stud framing with insulation • Minimum 20mm air-gap • 25mm shaftliner or intershield encased in interhome H-studs • Minimum 20mm air-gap • Steel stud framing with insulation • 10mm soundshield or opal 		Fire Resistance Level 60/60/60 rated for the wall frame opposite to fire attack Fire Report FC11661		
	Minimum Cavity On Each Side (mm)	Wall Width (mm)	Sound Insulation Rw (Rw + Ctr)			
	Cavity size = stud size + air-gap		2 x Pink® Batts Wall R2.5 HD			Acoustic Report Day Design 3094-42 Note: Impact Sound Resistant - Discontinuous Construction
	110 (eg: 70 stud + 40 gap or 90 stud + 20 gap)	265	62 (50)			

IHW10		<ul style="list-style-type: none"> • 13mm soundshield or trurock • Steel stud framing with insulation • Minimum 20mm air-gap • 25mm shaftliner or intershield encased in interhome H-studs • Minimum 20mm air-gap • Steel stud framing with insulation • 13mm soundshield or trurock 				Fire Resistance Level 60/60/60 rated for the wall frame opposite to fire attack Fire Report FC11661	
	Minimum Cavity On Each Side (mm)	Wall Width (mm)	Sound Insulation Rw (Rw + Ctr)				
	Cavity size = stud size + air-gap		2 x Pink® Batts Wall R2.0	2 x Pink® Batts Wall R2.5 HD	2 x Polyester R1.5	2 x Polyester R2.0	Acoustic Report Day Design 3094-42 Note: Impact Sound Resistant - Discontinuous Construction
	90 (eg: 70 stud + 20 gap)	231	65 (52)	66 (53)	60 (50)	62 (51)	
110 (eg: 90 stud + 20 gap)	271	65 (55)	67 (56)	61 (52)	63 (53)		

IHW12		<ul style="list-style-type: none"> • 13mm watershield • Steel stud framing with insulation • Minimum 20mm air-gap • 25mm shaftliner or intershield encased in interhome H-studs • Minimum 20mm air-gap • Steel stud framing with insulation • 13mm watershield 			Fire Resistance Level 60/60/60 rated for the wall frame opposite to fire attack Fire Report FC11661	
	Minimum Cavity On Each Side (mm)	Wall Width (mm)	Sound Insulation Rw (Rw + Ctr)			
	Cavity size = stud size + air-gap		2 x Pink® Batts Wall R2.0	2 x Pink® Batts Wall R2.5 HD	2 x Polyester R2.0	Acoustic Report Day Design 3094-42 Note: Impact Sound Resistant - Discontinuous Construction
	90 (eg: 70 stud + 20 gap)	231	-	63 (50)	-	
110 (eg: 90 stud + 20 gap)	271	62 (51)	64 (51)	61 (50)		

IHW50		<ul style="list-style-type: none"> • 13mm mastashield • Steel stud framing with insulation • Minimum 20mm air-gap • 25mm shaftliner or intershield encased in interhome H-studs • Minimum 20mm air-gap • Steel stud framing with insulation • 13mm mastashield 		Fire Resistance Level 60/60/60 rated for the wall frame opposite to fire attack Fire Report FC11661		
	Minimum Cavity On Each Side (mm)	Wall Width (mm)	Sound Insulation Rw (Rw + Ctr)			
	Cavity size = stud size + air-gap		2 x Pink® Batts Wall R2.0			INSUL v8 Acoustic Prediction Note: Impact Sound Resistant - Discontinuous Construction
	110 (eg: 70 stud + 40 gap or 90 stud + 20 gap)	271	65 (50)			



IHW51		Fire Resistance Level												
	<ul style="list-style-type: none"> • 13mm mastashield • Steel stud framing with insulation • Minimum 20mm air-gap • 25mm shaftliner or intershield encased in interhome H-studs • Minimum 20mm air-gap • Steel stud framing with insulation • 13mm watershield 													
	<p>60/60/60 rated for the wall frame opposite to fire attack</p> <p>Fire Report FC11661</p>													
	<table border="1"> <thead> <tr> <th>Minimum Cavity On Each Side (mm)</th> <th>Wall Width (mm)</th> <th colspan="2">Sound Insulation Rw (Rw + Ctr)</th> </tr> </thead> <tbody> <tr> <td>Cavity size = stud size + air-gap</td> <td></td> <td colspan="2">2 x Pink® Batts Wall R2.0</td> </tr> <tr> <td>110 (eg: 70 stud + 40 gap or 90 stud + 20 gap)</td> <td>271</td> <td colspan="2">66 (52)</td> </tr> </tbody> </table>	Minimum Cavity On Each Side (mm)	Wall Width (mm)	Sound Insulation Rw (Rw + Ctr)		Cavity size = stud size + air-gap		2 x Pink® Batts Wall R2.0		110 (eg: 70 stud + 40 gap or 90 stud + 20 gap)	271	66 (52)		<p>INSUL v8 Acoustic Prediction</p> <p>Note: Impact Sound Resistant - Discontinuous Construction</p>
Minimum Cavity On Each Side (mm)	Wall Width (mm)	Sound Insulation Rw (Rw + Ctr)												
Cavity size = stud size + air-gap		2 x Pink® Batts Wall R2.0												
110 (eg: 70 stud + 40 gap or 90 stud + 20 gap)	271	66 (52)												

IHW52		Fire Resistance Level												
	<ul style="list-style-type: none"> • 13mm mastashield • Steel stud framing with insulation • Minimum 20mm air-gap • 25mm shaftliner or intershield encased in interhome H-studs • Minimum 20mm air-gap • Steel stud framing with insulation • 6mm Villaboard™ 													
	<p>60/60/60 rated for the wall frame opposite to fire attack</p> <p>Fire Report FC11661</p>													
	<table border="1"> <thead> <tr> <th>Minimum Cavity On Each Side (mm)</th> <th>Wall Width (mm)</th> <th colspan="2">Sound Insulation Rw (Rw + Ctr)</th> </tr> </thead> <tbody> <tr> <td>Cavity size = stud size + air-gap</td> <td></td> <td colspan="2">2 x Pink® Batts Wall R2.0</td> </tr> <tr> <td>110 (eg: 70 stud + 40 gap or 90 stud + 20 gap)</td> <td>264</td> <td colspan="2">65 (51)</td> </tr> </tbody> </table>	Minimum Cavity On Each Side (mm)	Wall Width (mm)	Sound Insulation Rw (Rw + Ctr)		Cavity size = stud size + air-gap		2 x Pink® Batts Wall R2.0		110 (eg: 70 stud + 40 gap or 90 stud + 20 gap)	264	65 (51)		<p>INSUL v8 Acoustic Prediction</p> <p>Note: Impact Sound Resistant - Discontinuous Construction</p>
Minimum Cavity On Each Side (mm)	Wall Width (mm)	Sound Insulation Rw (Rw + Ctr)												
Cavity size = stud size + air-gap		2 x Pink® Batts Wall R2.0												
110 (eg: 70 stud + 40 gap or 90 stud + 20 gap)	264	65 (51)												

IHW13		Fire Resistance Level																			
	<ul style="list-style-type: none"> • 13mm fireshield or multishield • Steel stud framing with insulation • Minimum 20mm air-gap • 25mm shaftliner or intershield encased in interhome H-studs • Minimum 20mm air-gap • Steel stud framing with insulation • 13mm fireshield or multishield 																				
	<p>60/60/60 rated for the wall frame opposite to fire attack</p> <p>Fire Report FC11661</p>																				
	<table border="1"> <thead> <tr> <th>Minimum Cavity On Each Side (mm)</th> <th>Wall Width (mm)</th> <th colspan="3">Sound Insulation Rw (Rw + Ctr)</th> </tr> </thead> <tbody> <tr> <td>Cavity size = stud size + air-gap</td> <td></td> <td>2 x Pink® Batts Wall R2.0</td> <td>2 x Pink® Batts Wall R2.5 HD</td> <td>2 x Polyester R2.0</td> </tr> <tr> <td>90 (eg: 70 stud + 20 gap)</td> <td>231</td> <td>-</td> <td>63 (50)</td> <td>-</td> </tr> <tr> <td>110 (eg: 90 stud + 20 gap)</td> <td>271</td> <td>62 (50)</td> <td>64 (51)</td> <td>61 (50)</td> </tr> </tbody> </table>	Minimum Cavity On Each Side (mm)	Wall Width (mm)	Sound Insulation Rw (Rw + Ctr)			Cavity size = stud size + air-gap		2 x Pink® Batts Wall R2.0	2 x Pink® Batts Wall R2.5 HD	2 x Polyester R2.0	90 (eg: 70 stud + 20 gap)	231	-	63 (50)	-	110 (eg: 90 stud + 20 gap)	271	62 (50)	64 (51)	61 (50)
Minimum Cavity On Each Side (mm)	Wall Width (mm)	Sound Insulation Rw (Rw + Ctr)																			
Cavity size = stud size + air-gap		2 x Pink® Batts Wall R2.0	2 x Pink® Batts Wall R2.5 HD	2 x Polyester R2.0																	
90 (eg: 70 stud + 20 gap)	231	-	63 (50)	-																	
110 (eg: 90 stud + 20 gap)	271	62 (50)	64 (51)	61 (50)																	

IHW15		Fire Resistance Level																			
	<ul style="list-style-type: none"> • 2 layers of 10mm mastashield or watershield • Steel stud framing with insulation • Minimum 20mm air-gap • 25mm shaftliner or intershield encased in interhome H-studs • Minimum 20mm air-gap • Steel stud framing with insulation • 2 layers of 10mm mastashield or watershield 																				
	<p>60/60/60 rated for the wall frame opposite to fire attack</p> <p>Fire Report FC11661</p>																				
	<table border="1"> <thead> <tr> <th>Minimum Cavity On Each Side (mm)</th> <th>Wall Width (mm)</th> <th colspan="3">Sound Insulation Rw (Rw + Ctr)</th> </tr> </thead> <tbody> <tr> <td>Cavity size = stud size + air-gap</td> <td></td> <td>2 x Pink® Batts Wall R2.0</td> <td>2 x Pink® Batts Wall R2.5 HD</td> <td>2 x Polyester R1.5</td> </tr> <tr> <td>90 (eg: 70 stud + 20 gap)</td> <td>245</td> <td>64 (51)</td> <td>66 (52)</td> <td>-</td> </tr> <tr> <td>110 (eg: 90 stud + 20 gap)</td> <td>285</td> <td>66 (53)</td> <td>67 (54)</td> <td>61 (50)</td> </tr> </tbody> </table>	Minimum Cavity On Each Side (mm)	Wall Width (mm)	Sound Insulation Rw (Rw + Ctr)			Cavity size = stud size + air-gap		2 x Pink® Batts Wall R2.0	2 x Pink® Batts Wall R2.5 HD	2 x Polyester R1.5	90 (eg: 70 stud + 20 gap)	245	64 (51)	66 (52)	-	110 (eg: 90 stud + 20 gap)	285	66 (53)	67 (54)	61 (50)
Minimum Cavity On Each Side (mm)	Wall Width (mm)	Sound Insulation Rw (Rw + Ctr)																			
Cavity size = stud size + air-gap		2 x Pink® Batts Wall R2.0	2 x Pink® Batts Wall R2.5 HD	2 x Polyester R1.5																	
90 (eg: 70 stud + 20 gap)	245	64 (51)	66 (52)	-																	
110 (eg: 90 stud + 20 gap)	285	66 (53)	67 (54)	61 (50)																	



IHW36				Fire Resistance Level		
	<ul style="list-style-type: none"> • 13mm mastashield or watershield • Steel stud framing with insulation • Minimum 20mm air-gap • 25mm shaftliner or intershield encased in interhome H-studs • Minimum 20mm air-gap • Steel stud framing with insulation • 2 layers of 13mm mastashield or watershield 				<p>60/60/60 rated for the wall frame opposite to fire attack</p> <p>Fire Report FC11661</p>	
	Minimum Cavity On Each Side (mm)	Wall Width (mm)	Sound Insulation Rw (Rw + Ctr)		<p>Acoustic Report Day Design 5008-7</p> <p>Note: Impact Sound Resistant - Discontinuous Construction</p>	
	Cavity size = stud size + air-gap		2 x Pink® Batts Wall R2.0	2 x Pink® Batts Wall R2.5 HD		
	90 (eg: 70 stud + 20 gap)	244	64 (50)	64 (51)		
110 (eg: 90 stud + 20 gap)	284	64 (50)	65 (51)			

IHW53				Fire Resistance Level		
	<ul style="list-style-type: none"> • 2 layers of 10mm mastashield or watershield • Steel stud framing with insulation • Minimum 20mm air-gap • 25mm shaftliner or intershield encased in interhome H-studs • Minimum 20mm air-gap • Steel stud framing with insulation • 6mm Villaboard™ 				<p>60/60/60 rated for the wall frame opposite to fire attack</p> <p>Fire Report FC11661</p>	
	Minimum Cavity On Each Side (mm)	Wall Width (mm)	Sound Insulation Rw (Rw + Ctr)		<p>INSUL v8 Acoustic Prediction</p> <p>Note: Impact Sound Resistant - Discontinuous Construction</p>	
	Cavity size = stud size + air-gap		2 x Pink® Batts Wall R2.0			
	110 (eg: 70 stud + 40 gap or 90 stud + 20 gap)	271	69 (54)			

IHW26				Fire Resistance Level		
	<ul style="list-style-type: none"> • 6mm Villaboard™ • Steel stud framing with insulation • Minimum 20mm air-gap • 25mm shaftliner or intershield encased in interhome H-studs • Minimum 20mm air-gap • Steel stud framing with insulation • 6mm Villaboard™ 				<p>60/60/60 rated for the wall frame opposite to fire attack</p> <p>Fire Report FC11661</p>	
	Minimum Cavity On Each Side (mm)	Wall Width (mm)	Sound Insulation Rw (Rw + Ctr)		<p>INSUL v8 Acoustic Prediction</p> <p>Note: Impact Sound Resistant - Discontinuous Construction</p>	
	Cavity size = stud size + air-gap		2 x Pink® Batts Wall R2.5 HD			
	110 (eg: 70 stud + 40 gap or 90 stud + 20 gap)	257	65 (51)			

Ceiling Attenuation Class Systems

CAC170

Set plasterboard ceiling divided by **interhome** Wall System

[This system is suitable for timber or steel roof framing]

[Sound insulation numbers based on minimum 200mm cavity]

[Wall to ceiling junction must be square set or finished with cornice to achieve acoustic rating]

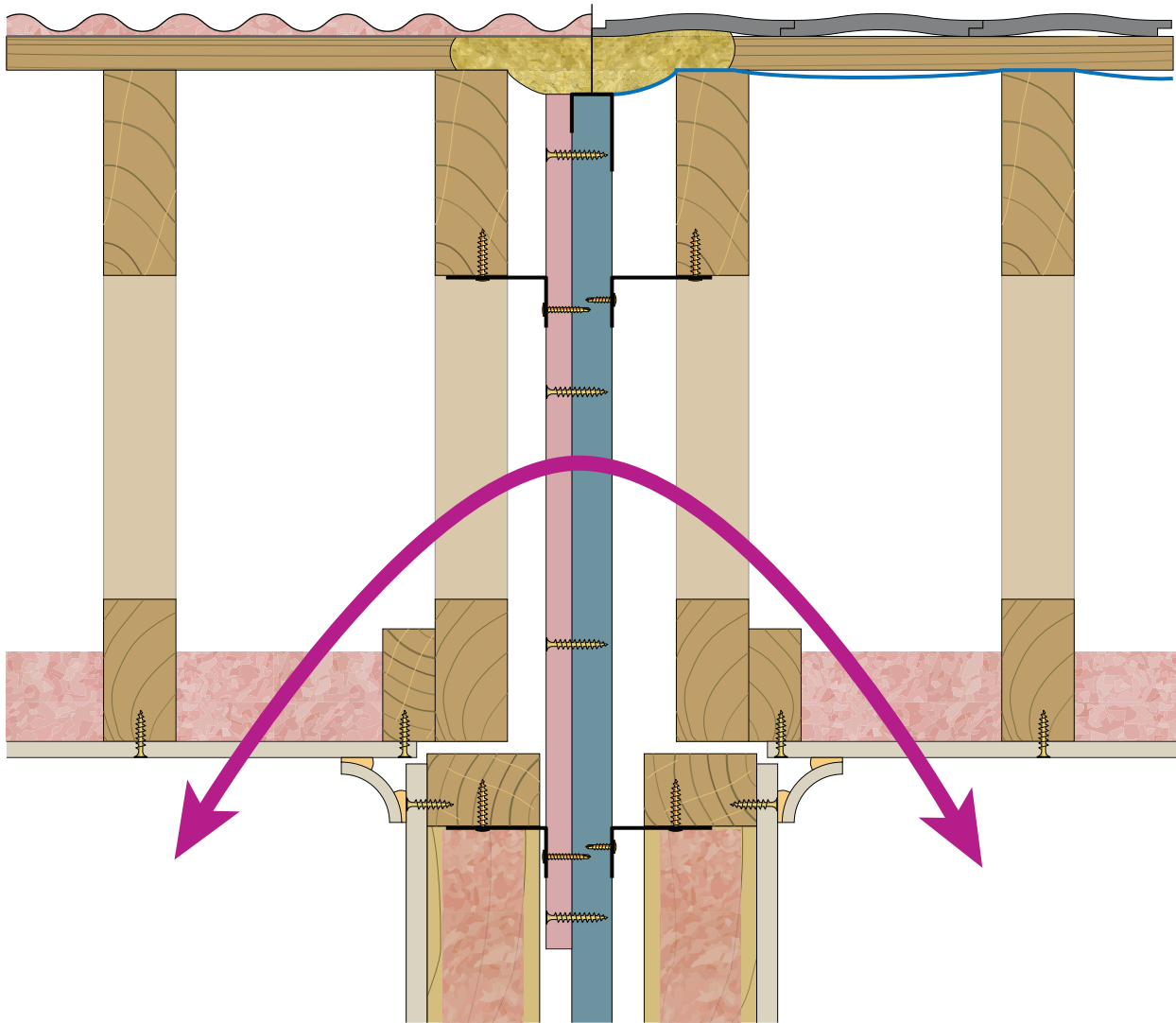

System	Ceiling Lining	Airborne Sound Insulation Rw (Rw + Ctr)	
		Minimum R1.5 Pink® Batts over the ceiling 1200mm from the Shaftliner or Intershield on both sides	Acoustic Report Day Design 4738-5
CAC170	1 layer of 10mm mastashield or spanshield	60 (50)	



CAC171

Set plasterboard ceiling divided by **interhome** Wall System

[This system is suitable for timber or steel framing]

[Sound insulation numbers based on minimum 200mm cavity]

[Wall to ceiling junction must be square set or finished with cornice to achieve acoustic rating]

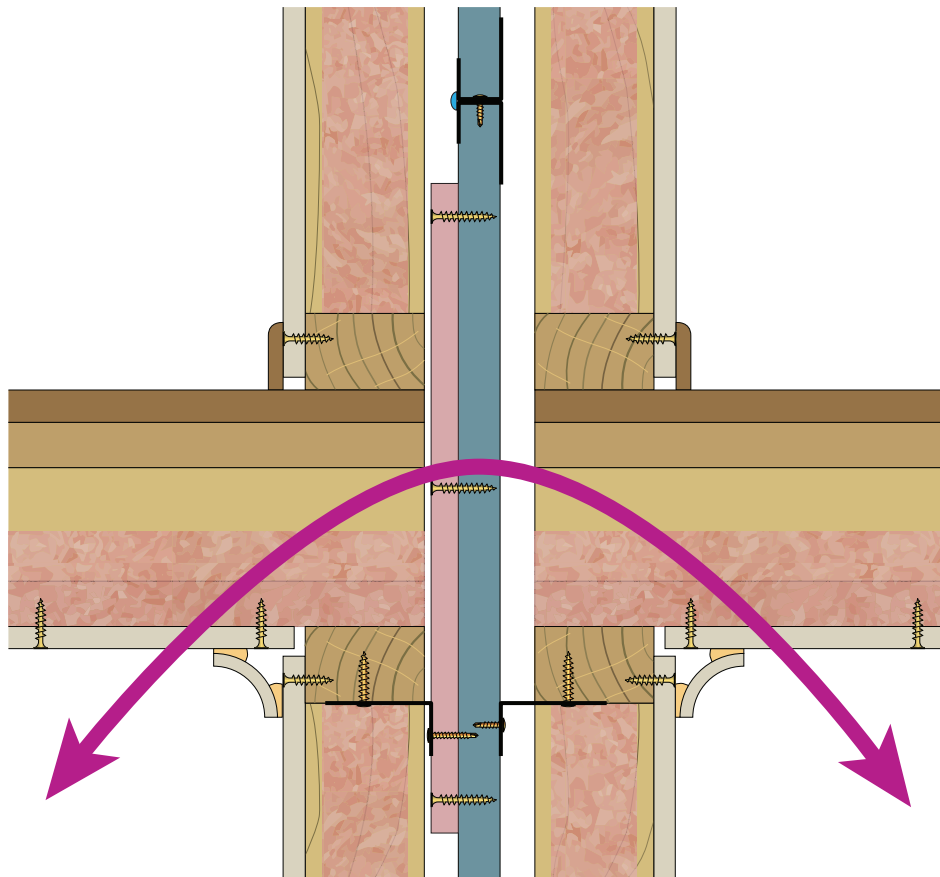

System	Ceiling Lining	Airborne Sound Insulation Rw (Rw + Ctr)	
		Minimum R1.5 Pink® Batts over the ceiling 1200mm from the Shaftliner or Intershield on both sides	Acoustic Report Day Design 4738-16
CAC171	1 layer of 10mm mastashield or spanshield	60 (50)	

CAC172

Set plasterboard ceiling divided by **interhome** Wall System

[This system is suitable for timber or steel framing]

[Sound insulation numbers based on minimum 200mm cavity]

[Wall to ceiling junction must be square set or finished with cornice to achieve acoustic rating]

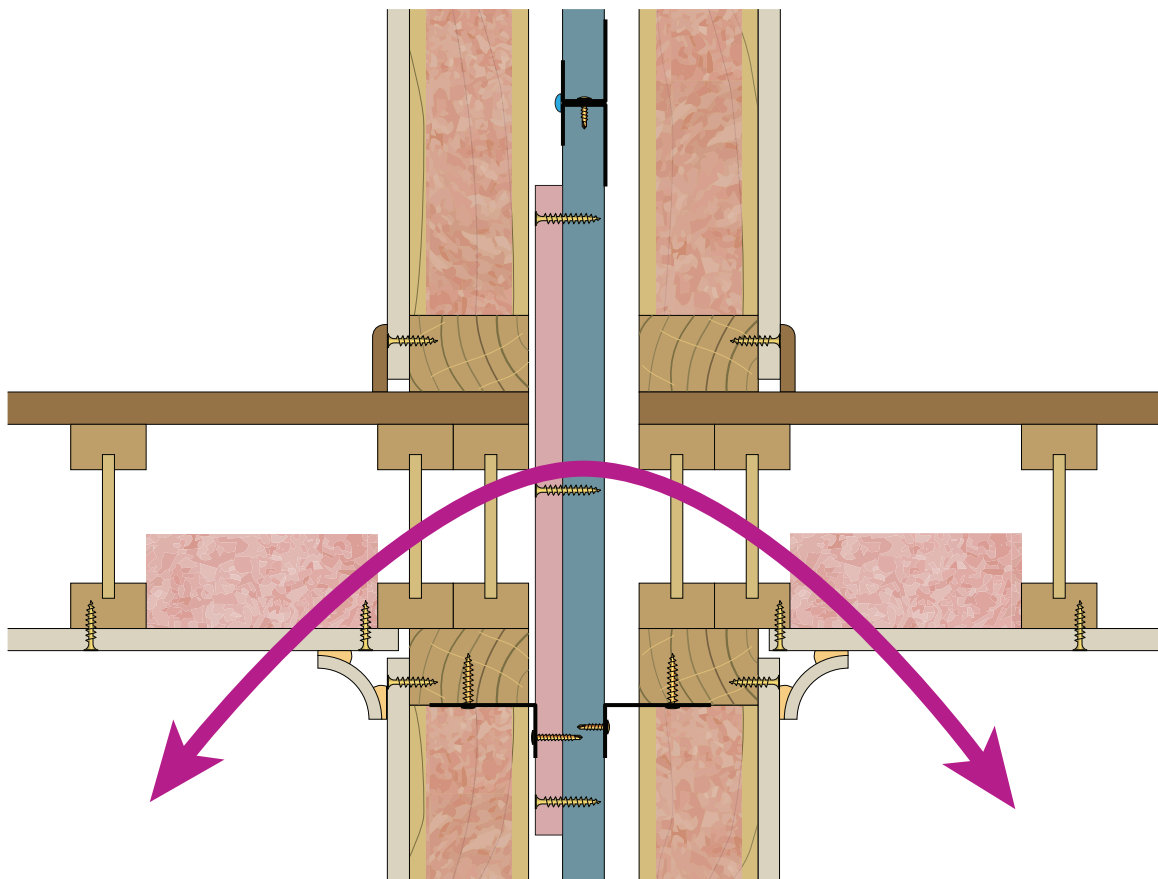

System	Ceiling Lining	Airborne Sound Insulation Rw (Rw + Ctr)		
		No Insulation	Minimum R1.5 Pink [®] Batts over the ceiling in adjacent cavities on both sides	
CAC172	1 layer of 10mm mastashield or spanshield	60 (50)	64 (54)	



Components

Steel Profiles

- > Siniat 25mm **interhome** H-stud

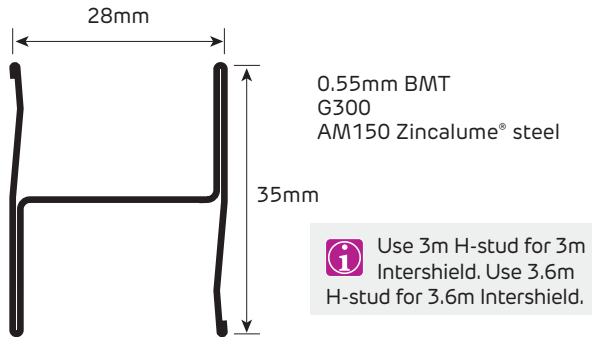

Product Code	Length (mm)
IHS25-30	3000
IHS25-36	3600

FIGURE 4 **interhome** H-stud Profile

- > Siniat J-Track

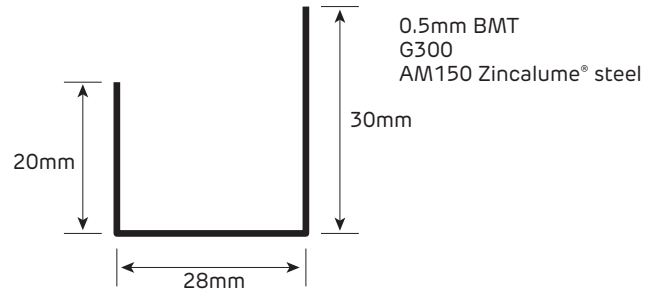

Product Code	Length (mm)
T28-30	3000

FIGURE 5 **J-Track** Profile

Plasterboard

Central Fire Barrier

- > Siniat 25mm **shaftliner** or **intershield**

Wall Linings

- > Siniat **mastashield**
- > Siniat **soundshield**
- > Siniat **opal**
- > Siniat **watershield**
- > Siniat **fireshield**
- > Siniat **multishield**
- > James Hardie Villaboard™

Wall Insulation

- > Fletcher Pink Batts® Wall Insulation or Fletcher Firmasoft™ Wall Insulation (glasswool)
- > Polyester wall insulation

Fire Rated Mineral Wool

- > Fletcher Fire Stop Party Wall Batts

Sealant

- > **bindex** fire and acoustic sealant

Aluminium Clip

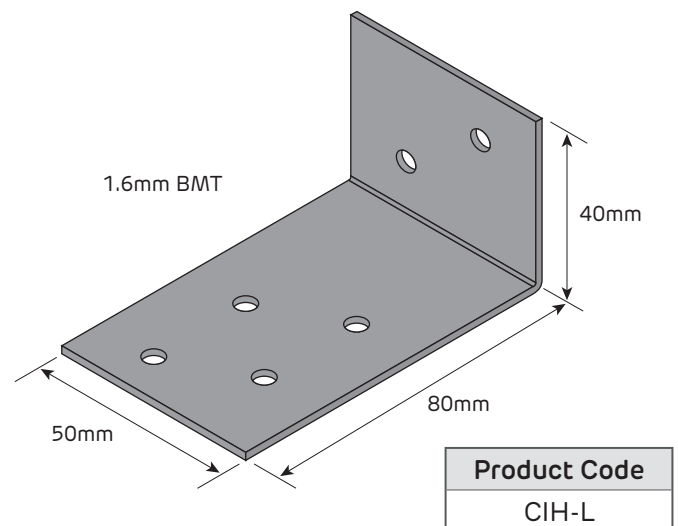

FIGURE 6 **interhome** aluminium clip Isometric

Fasteners

Refer to 'Framing' for information on fasteners use in the **interhome** wall system.



General Requirements

Use a central fire barrier of interhome H-studs with 25mm shaftliner or intershield [Figures 7 and 8]
Use only interhome aluminium clips (CIH-L) to connect H-studs to the stud frames on either side. Aluminium will melt in a fire so the frame of the dwelling on the fire side can detach from the central fire barrier.
Leave a gap of at least 20mm between the shaftliner or intershield in the central fire barrier and the studs of both wall frames. A gap of at least 25mm is recommended on the side that has the additional 16mm fireshield or multishield laminated to the shaftliner or intershield .
Control joints are not required in the central fire barrier.
Prevent contact between services in the wall cavities and the central fire barrier.
Apply bindex fire and acoustic sealant to all gaps in the central fire barrier to maintain fire and acoustic integrity. If sheets or tracks are touch fitting and no gap exists, fire sealant is not required.
Pack any gaps between the top of the central fire barrier and the underside of the roof covering with Fletcher Insulation's Fire Stop Party Wall Batts to maintain the 60 minute fire rating.



Download a step-by-step installation video from www.siniat.com.au

Fire Resistance

All systems in this section are displayed with an FRL of 60/60/60 to indicate that they support the frame on the opposite side to fire attack. In a fire event, the framing on the fire side of the central fire barrier is considered to collapse before 60 minutes.
All interhome systems have a Fire Resistance Level (FRL) assigned by an Accredited Testing Laboratory in accordance with Schedule 5 of Volume One of the <i>National Construction Code (NCC)</i> and <i>AS 1530.4 Fire resistance tests for elements of construction</i> .
In the event of a fire, the interhome aluminium clips on the fire side are designed to melt and allow the frame to collapse, leaving the central fire barrier attached to the unaffected frame on the non-fire side.
The outer wall lining and cavity insulation of any interhome system can be used on one side of a different system without reducing its FRL. The linings may also transition along a wall from one interhome system to another.



Sound Insulation

Services installed in one cavity have an acoustic rating to the other side of the **interhome** wall of at least $R_w + C_{tr} 40$ which meets the requirements of the NCC for walls separating soil, waste or water supply pipes from a habitable room.

When the internal lining and cavity insulation of one **interhome** system is used on one side of a different **interhome** system, the acoustic rating is the lower of the two provided that the central fire barrier and stud cavity sizes are the same.

Framing

J-Tracks:

- > Position on the slab or footing 20mm minimum (25mm recommended) from the existing frame of the dwelling
- > Fix to concrete at 600mm maximum centres and 150mm maximum from track ends using concrete anchors
- > Fix to both vertical ends of central fire barrier. Screw fix vertical J-Track to horizontal J-Tracks [Figure 7]
- > Use back-to-back at the top of each row to form the top track and also the bottom tracks for the next level. Screw fix the back-to-back J-Tracks at 600mm maximum centres and 150mm from ends [Figure 9]

interhome H-studs:

- > Friction fit into bottom J-Track and push down completely. They are not required to be fastened to the top or bottom J-Tracks [Figure 7]
- > Space at 600mm centres. Alternate between **shaftliner** / **intershield** panels and H-Studs until the row is complete [Figures 15 - 16]
- > Use 3m H-Studs with 3m **shaftliner** / **intershield** panels and 3.6m H-Studs with 3.6m **shaftliner** / **intershield** panels.

Leave a gap of 20mm minimum between the central fire barrier and both of the dwelling's frames.

Maximum height is 12m for the central fire barrier

Fix **interhome aluminium clips** to both sides of each H-stud and vertical J-Track:

- > At the floor / ceiling levels on top or bottom plates
- > At the top chord of the trusses within 300mm of the top of the central fire barrier
- > At maximum 3m intervals for 3m **shaftliner** / **intershield** panels
- > At maximum 3.6m intervals for 3.6m **shaftliner** / **intershield** panels
- > Within 700mm from the top of H-Studs at a horizontal joint in the **shaftliner** / **intershield** (back-to-back J-Track) [Refer to Details].

It is critical to correctly fix the **interhome aluminium clips** only in the locations listed above to comply with the discontinuous construction requirements of the NCC.

Maximum wall height and distance between Aluminium Clips

Total Wall Height	Distance between Aluminium Clips
Up to 14m	2.7m maximum
Up to 12m	3.0m maximum
Up to 10.8m	3.2m maximum
Up to 9m	3.6m maximum



> Substituting **interhome aluminium clips** will significantly effect system performance

- > Plumbing and electrical services must not protrude beyond the face of the stud
- > If Interhome aluminium clips coincide with back to back J-track, install clips on top of both the H-stud and J-track

Fasteners

Fixing Aluminium Clips	Fastener
interhome aluminium clips to steel (2 screws)	8g x 16mm screw ²
interhome aluminium clips to steel interhome H-studs through 16mm fireshield / multishield (2 screws)	6g x 30mm screw ²
interhome aluminium clips to softwood timber (2 fasteners)	6g x 25mm screw or 2.8 x 30mm galvanised nail
Fixing J-Track	Fastener
Back to back J-tracks	8g x 16mm screw ²
Laminating	Fastener
Laminating fireshield / multishield to shaftliner / intershield	10g x 38mm coarse thread laminating screws ²

1. Fasteners gauges and lengths are minimums. Screws may be fine or coarse thread and must comply with Australian Standard 3566.1.
2. Maximum screw length is 40mm.

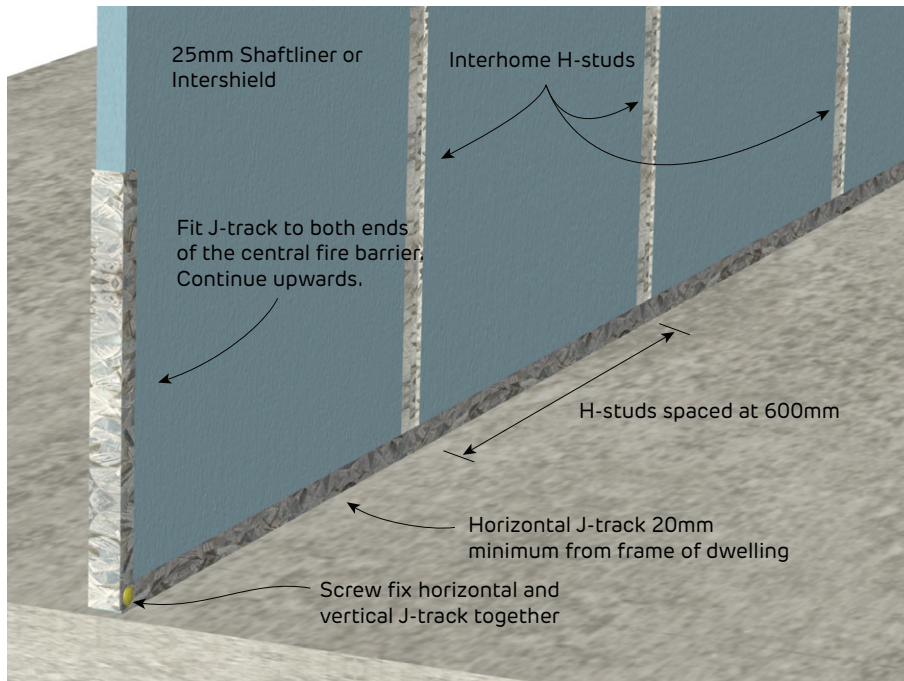

FIGURE 7 J-Track and H-Studs in Central Fire Barrier

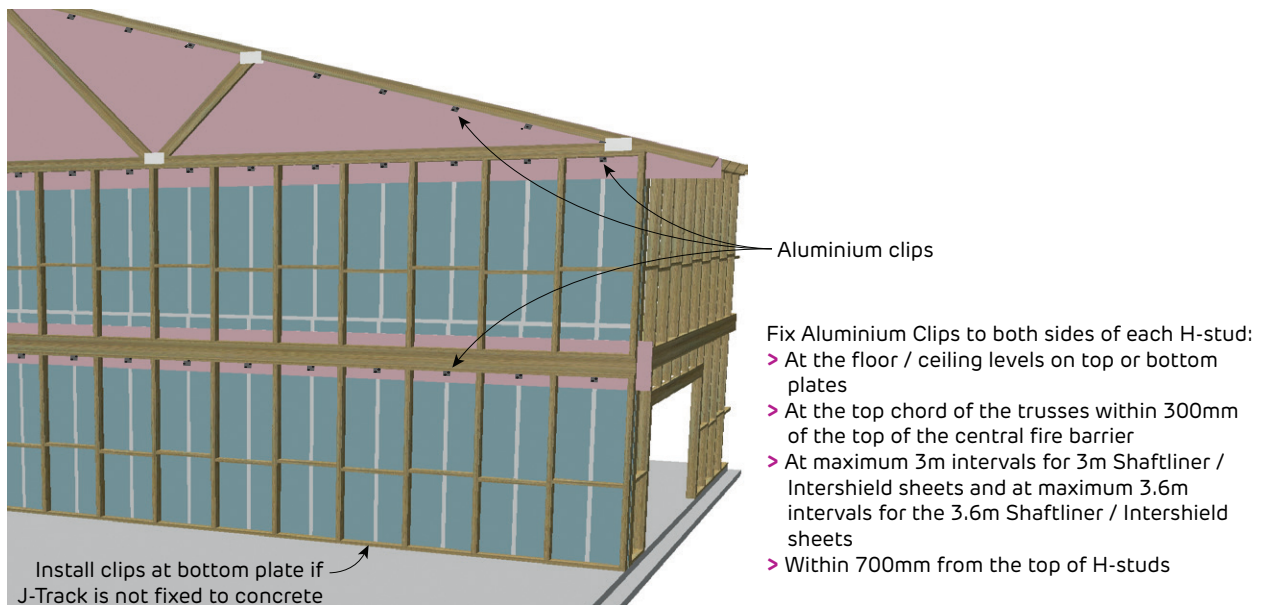

FIGURE 8 Location of Aluminium Clips

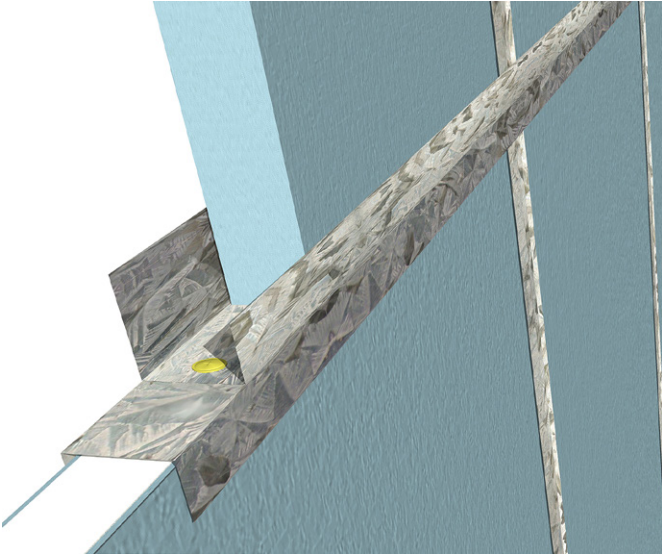

FIGURE 9 J-Track Back-to-back in Central Fire Barrier



FIGURE 10 Aluminium Clips to H-studs and Frame

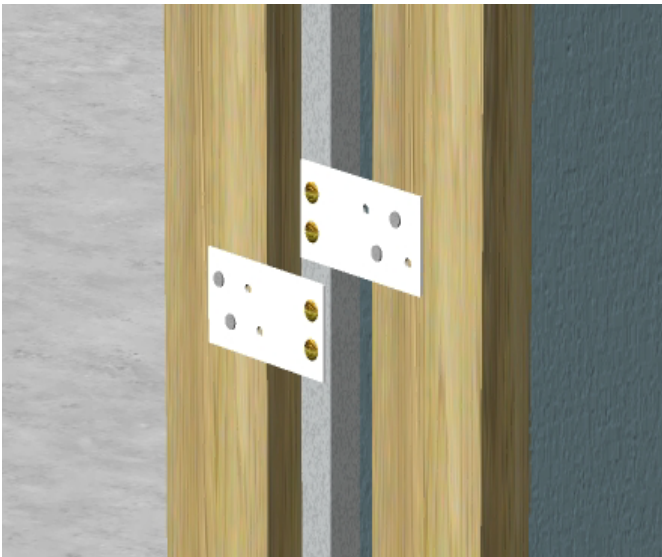

FIGURE 11 Aluminium Clips (flattened) at Central Fire Barrier Ends

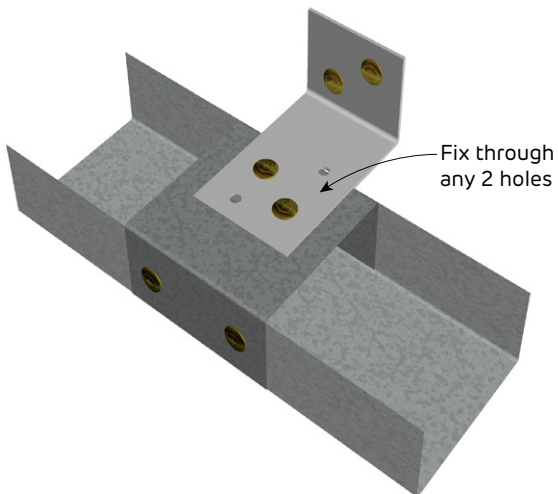

FIGURE 12 Interhome Aluminium Clip to Steel Frame

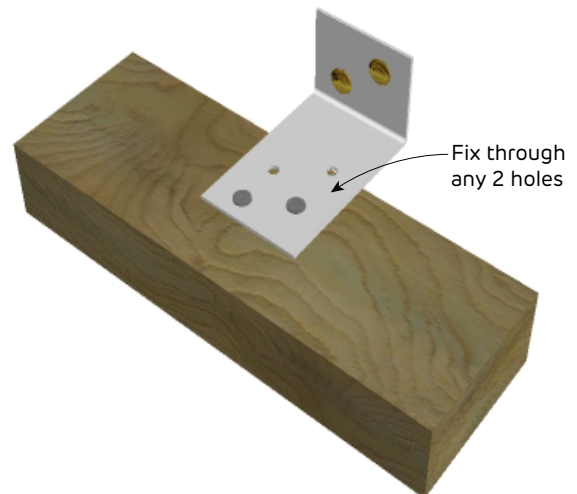

FIGURE 13 Interhome Aluminium Clip to Timber Frame

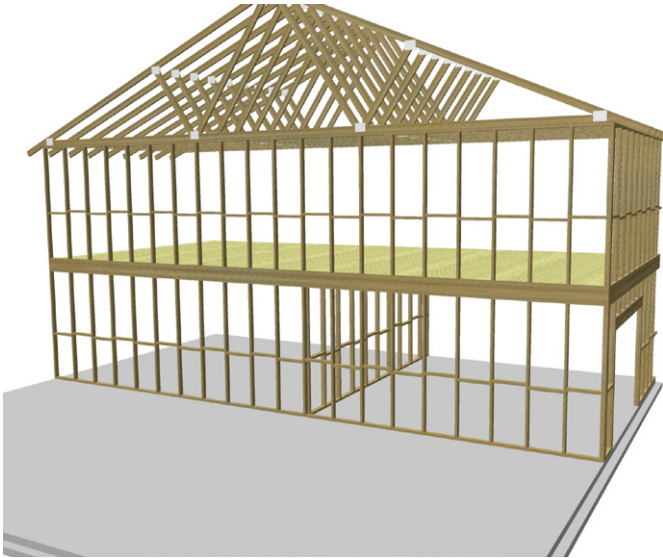

FIGURE 14 Install the Frame of the First Dwelling

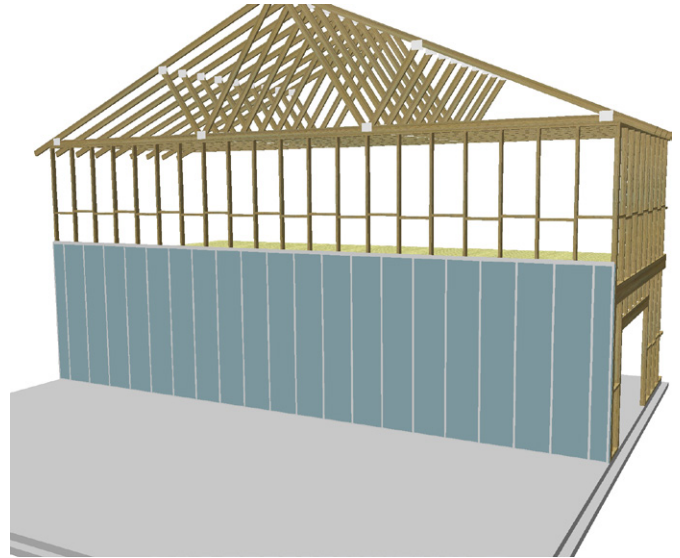

FIGURE 15 Install the First Row of the Central Fire Barrier

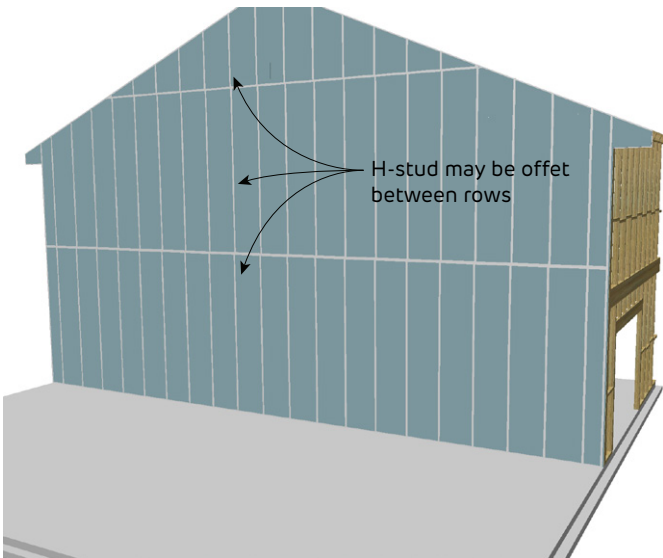

FIGURE 16 Continue Central Fire Barrier to the Roof Lining (for Non-combustible Roof Lining Only)

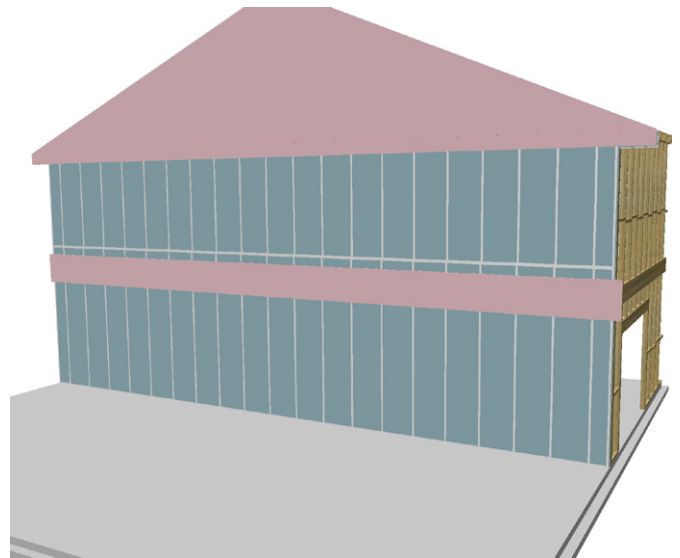

FIGURE 17 Laminate 16mm Fireshield or Multishield to Central Fire Barrier

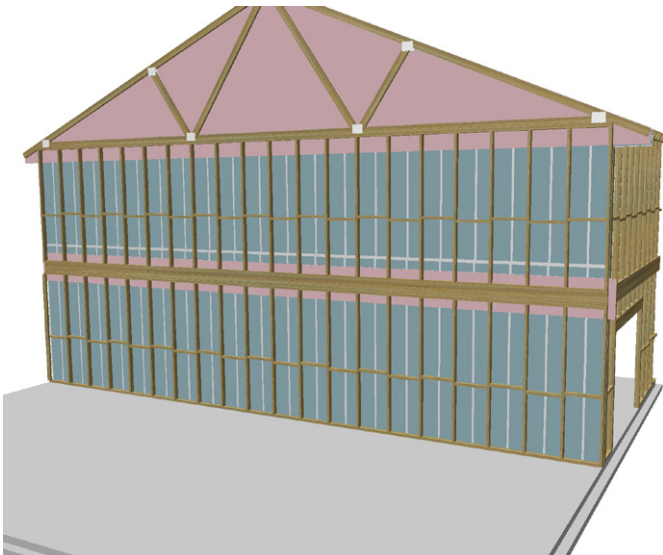

FIGURE 18 Install Frame of the Next Dwelling



Plasterboard Layout

Central Fire Barrier

Build the central fire barrier up to the underside of a non-combustible roof lining or 450mm above a combustible roof.

Maximum height is 12m for the central fire barrier.

Additional 16mm Fireshield or Multishield

Laminate an additional 16mm **fireshield** / **multishield** to the central fire barrier in the following locations:

- > At floor joists to 150mm above floor level [Figures 25, 30 - 34]
- > 150mm below ceilings [Figures 30 - 36, 38 - 41, 43, 47 - 48, 55]
- > Roof space [Figures 35 - 36, 38 - 41, 43, 47 - 48, 53]
- > Parapets [Figure 38]

Plasterboard Fixing

The **shaftliner** / **intershield** of the central fire barrier is friction fit into the **interhome** H-Stud and J-Track, no screws are required.

Install internal linings with either the Fastener and Adhesive method or the Fastener Only method. Both methods may be used to achieve the fire rating for the **interhome** system.

Intershield and Multishield

intershield and **multishield** are plasterboards that have been formulated to resist sound and fire as well as providing enhanced water and mould resistance. They are suitable for use in **interhome** systems where an FRL (Fire Resistance Level) and sound insulation rating are required. **intershield** and **multishield** have recycled blue liner paper.

The mould resistance technology used in **intershield** and **multishield** is enhanced by a water resistant additive. Together these unique features dramatically reduce mould growth under severe conditions.



Weather Protection of Central Fire Barrier

Protect from water.
Cover during adverse weather conditions by stapling plastic sheeting to the central fire barrier and the dwellings frame.
Avoid water pooling at the base between bottom plates/tracks.
Limit weather exposure of the central fire barrier to a maximum of 30 days.
Allow to dry out before installing insulation and internal linings.

Services and Penetrations

Avoid contact of services with the central fire barrier.
Penetration of the central fire barrier is only recommended in the roof space or below floor level and must follow fire rated installation details, or for Class 1 buildings NCC section 3.7.3.3 (b).
Seal all penetrations made through the internal linings to maintain the acoustic integrity.



> Electrical and plumbing services can be installed back-to-back in **interhome** systems without degrading the fire and acoustic performance.

> Services installed in one cavity have an acoustic rating to the other side of the **interhome** wall of at least $R_w + C_{tr} 40$

Protection of Penetrations in Internal Linings of Interhome Systems

Penetrations Type	To Maintain Fire Rating
PVC pipe up to 65mm	No fire collar needed and wet area sealant is permitted.
Copper plumbing	Wet area sealant is permitted.
Electrical outlet (GPO)	Can be attached via stud bracket or wall mount. No GPO fire rated wall-boxes are required.
Penetrations in roof cavity through central fire barrier	Refer to Figure 80 for cables. Any other penetration must be to a fire rated detail.
Any other gaps	Must be sealed with fire sealant.*

* Refer to Details for more information

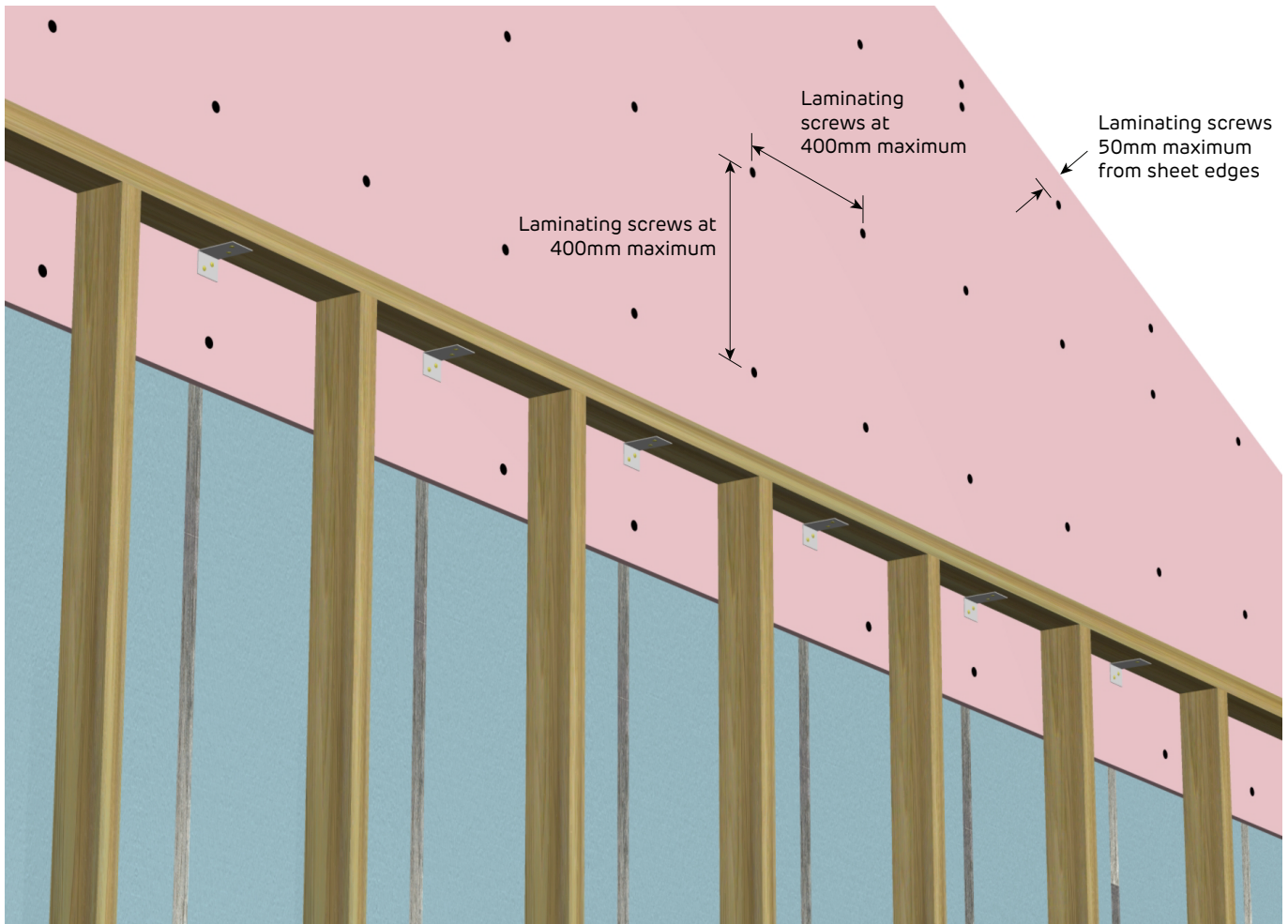

FIGURE 19 Fire Rated 1 Layer of 16mm Fireshield / Multishield
Laminating Screw Method

Fixing	Laminating screw method using 10g x 38mm laminating screw
Sheet Layout	Horizontal or Vertical
Recessed Edges and Butt Joints	Fix screws 10 - 50mm from sheet edges
Field	Laminate to central fire barrier at 400 x 400mm maximum centres
Fire Sealant	Use bindex fire and acoustic sealant on any gaps to maintain integrity, fireshield / multishield that has been touch fitted (no gaps) does not need to have fire sealant applied to joints. [Refer to Details]
Jointing	No plaster jointing required. Use bindex fire and acoustic sealant on any gaps up to 20mm wide.

FIGURE 20 Fire Rated 1 Layer - Horizontal Fastener Only Method

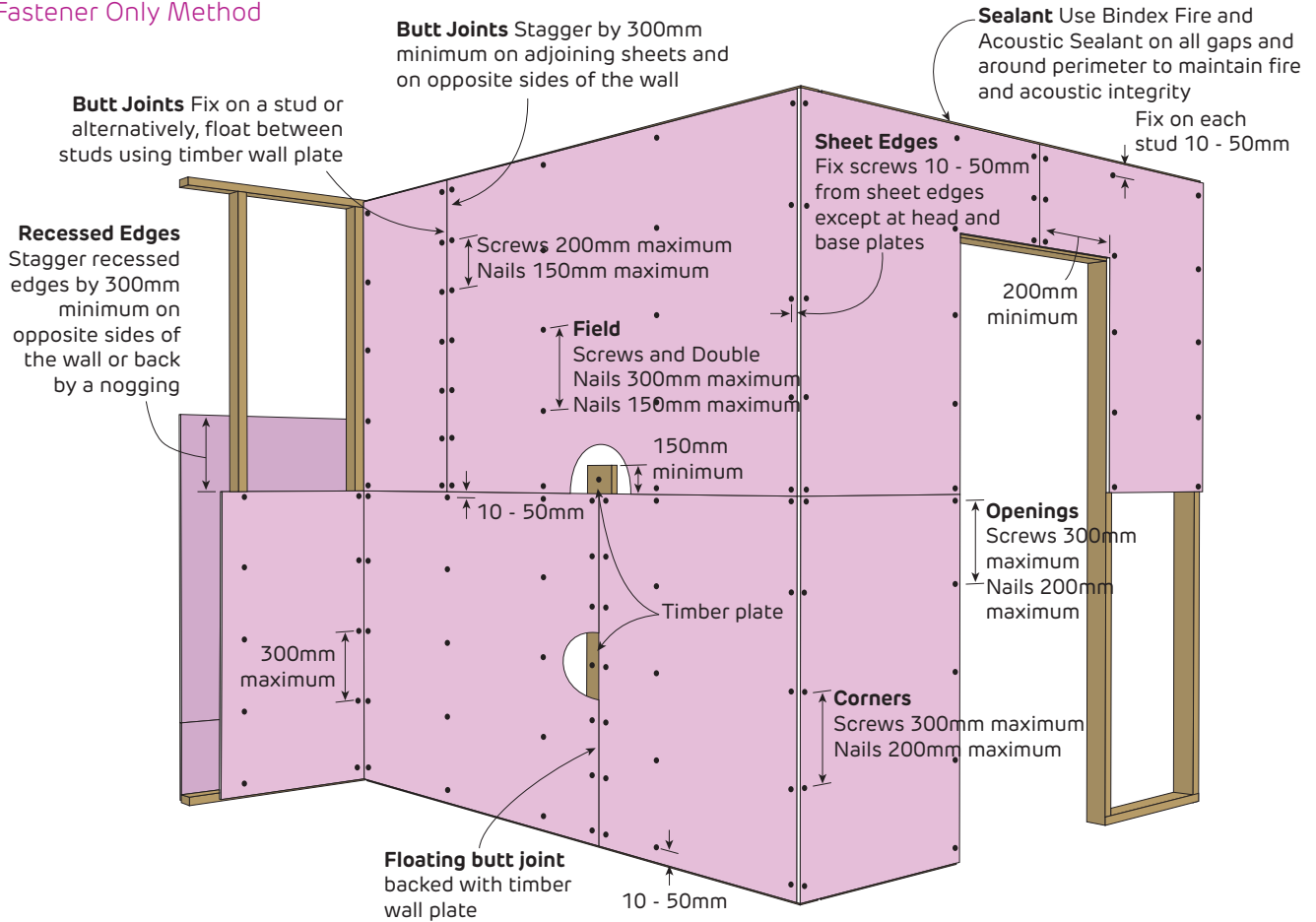
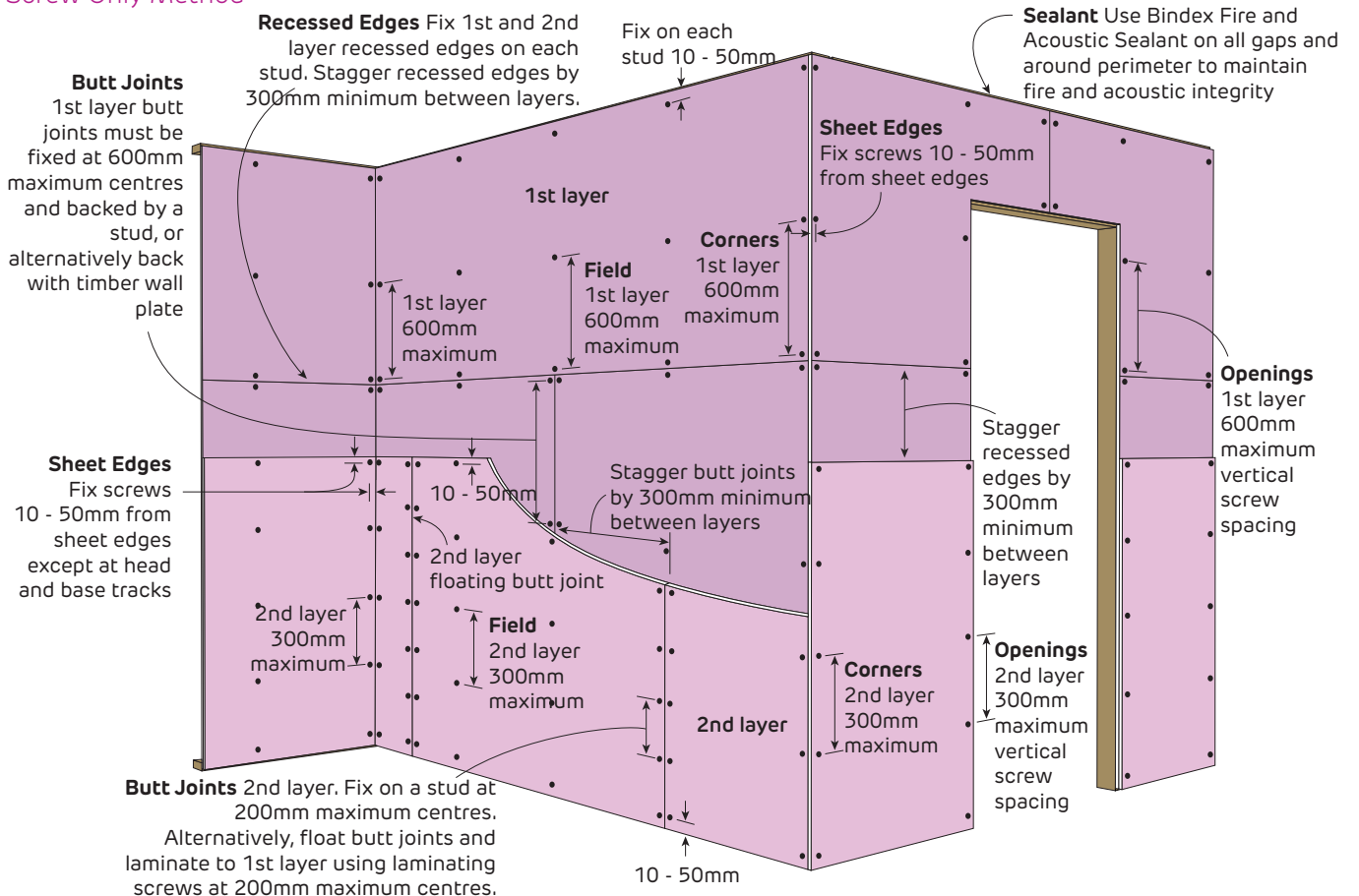

FIGURE 21 Fire Rated 2 Layers - Horizontal + Horizontal Screw Only Method





Fire Rated
Interhome Wall Base Details

i All Construction Details apply to timber and steel frames unless otherwise noted.

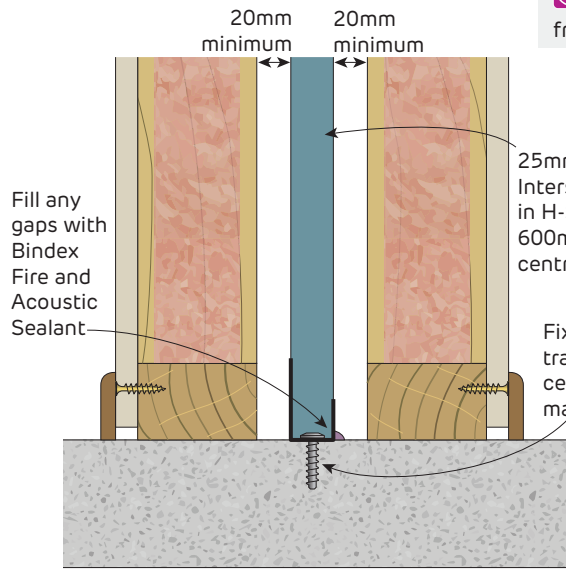

FIGURE 22 Interhome Wall Base to Slab
FRL 60/60/60
Section

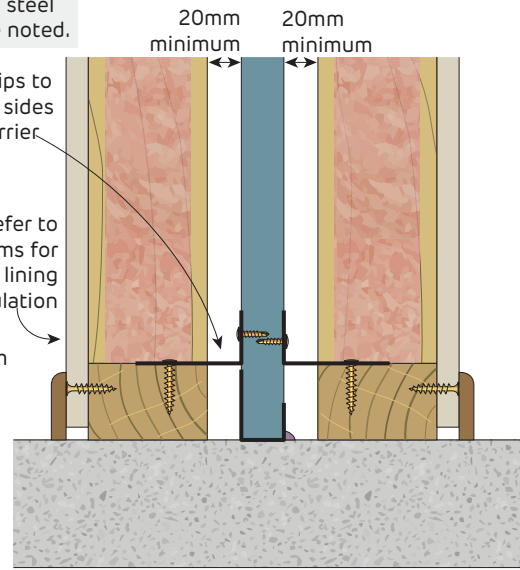

FIGURE 23 Interhome Wall Base to Slab - Alternate Detail
FRL 60/60/60
Section

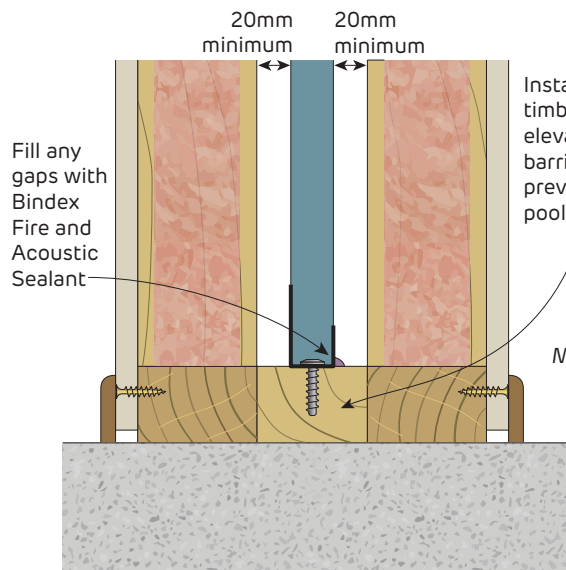

FIGURE 24 Interhome Wall Base to Slab for Improved Water Resistance
Timber Frame Only - FRL 60/60/60
Section

i Central fire barrier must be adequately propped during construction to prevent collapse.

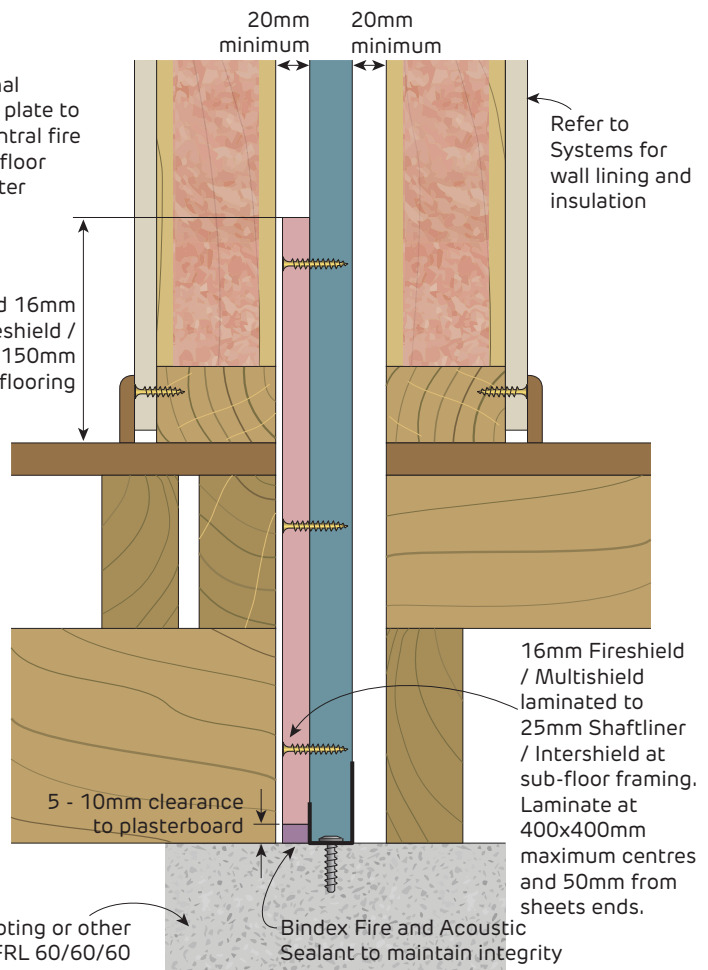
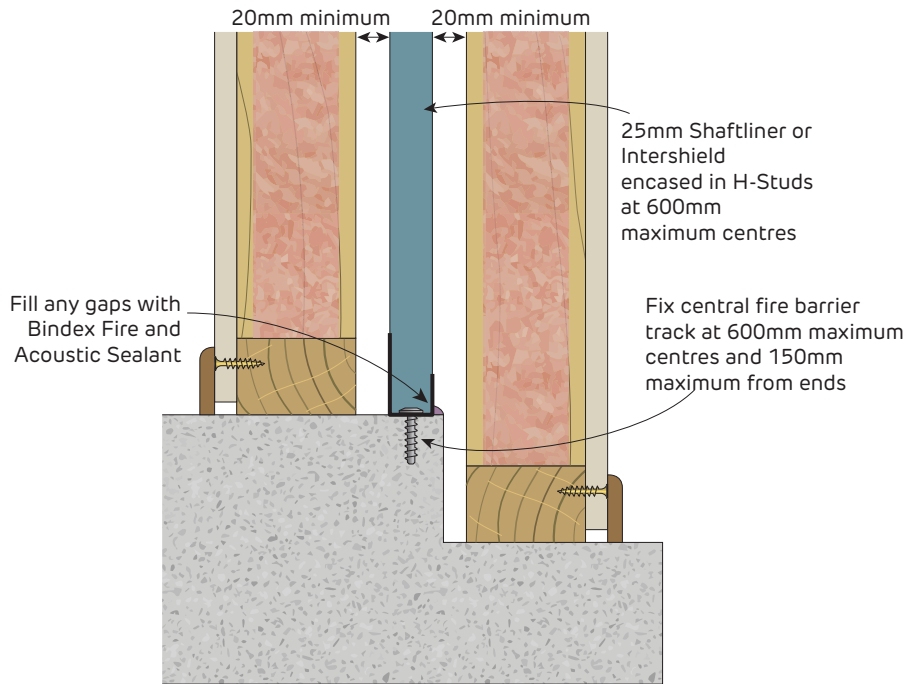
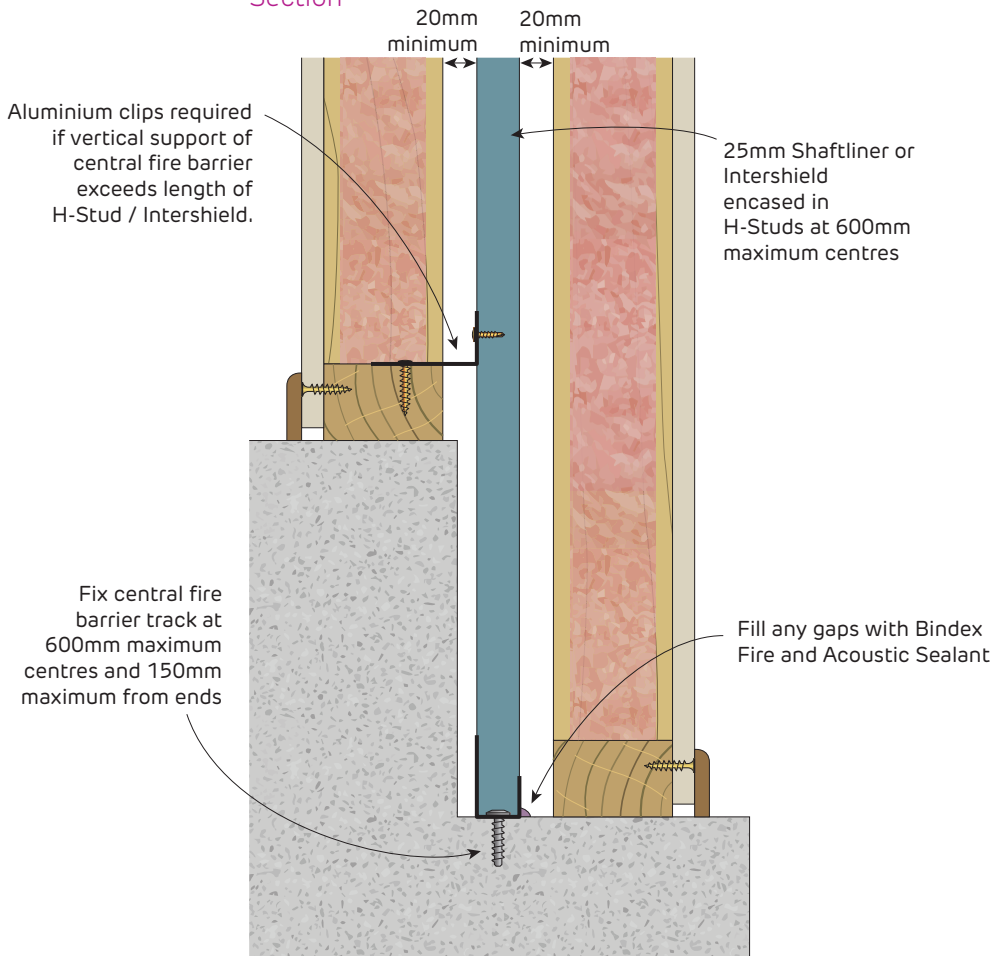

FIGURE 25 Suspended Ground Floor
FRL 60/60/60
Section

Fire Rated**Interhome Wall Base With Slab Step Down****FIGURE 26 Interhome Wall Base to Slab with Step-Down**

FRL 60/60/60

Section

**FIGURE 27 Interhome Wall Base to Slab with Larger Step-Down**

FRL 60/60/60

Section



Fire Rated

Interhome Wall Base With Slab Step Down

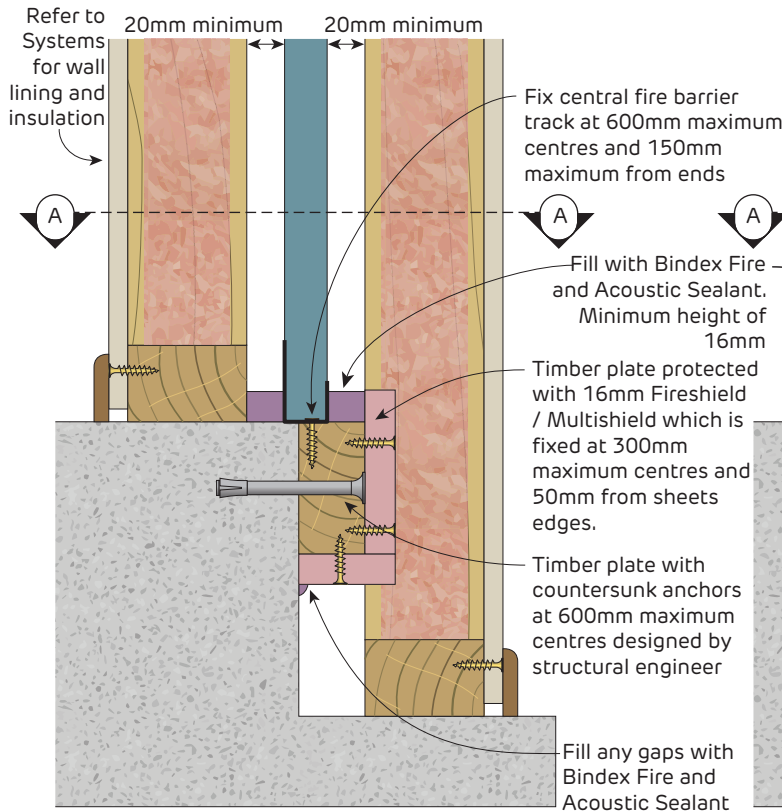

FIGURE 28 Interhome Wall Base to Slab with Step-Down and Timber Plate
FRL 60/60/60
Section

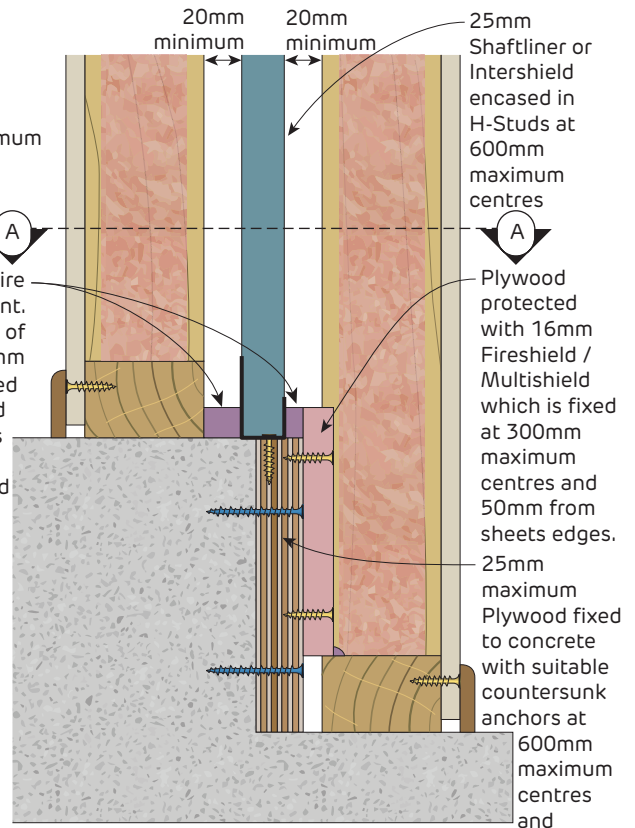
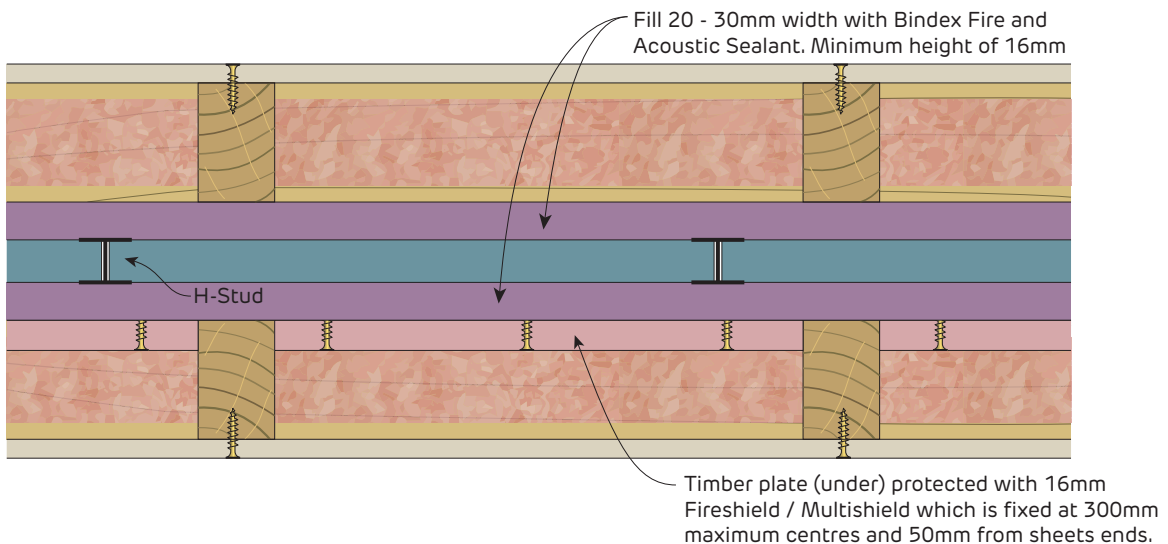

FIGURE 29 Interhome Wall Base to Slab with Step-Down and Plywood
FRL 60/60/60
Section



SECTION A-A Interhome Wall Base to Slab with Step-Down
FRL 60/60/60
Plan

Fire Rated

Interhome Wall To Upper Storey Floor

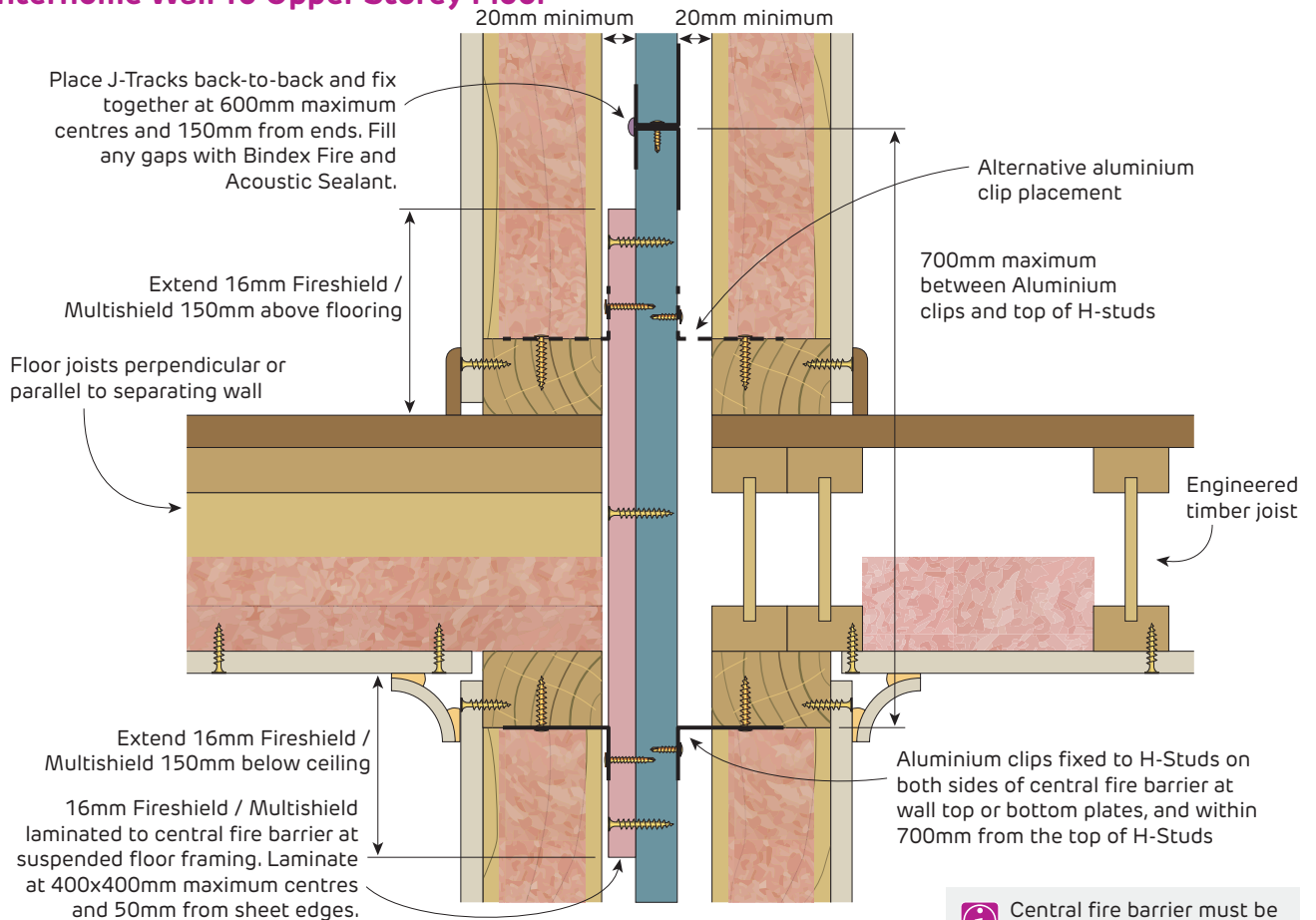

FIGURE 30 Interhome Wall to Upper Storey Floor
FRL 60/60/60
Section

Central fire barrier must be adequately propped during construction to prevent collapse.

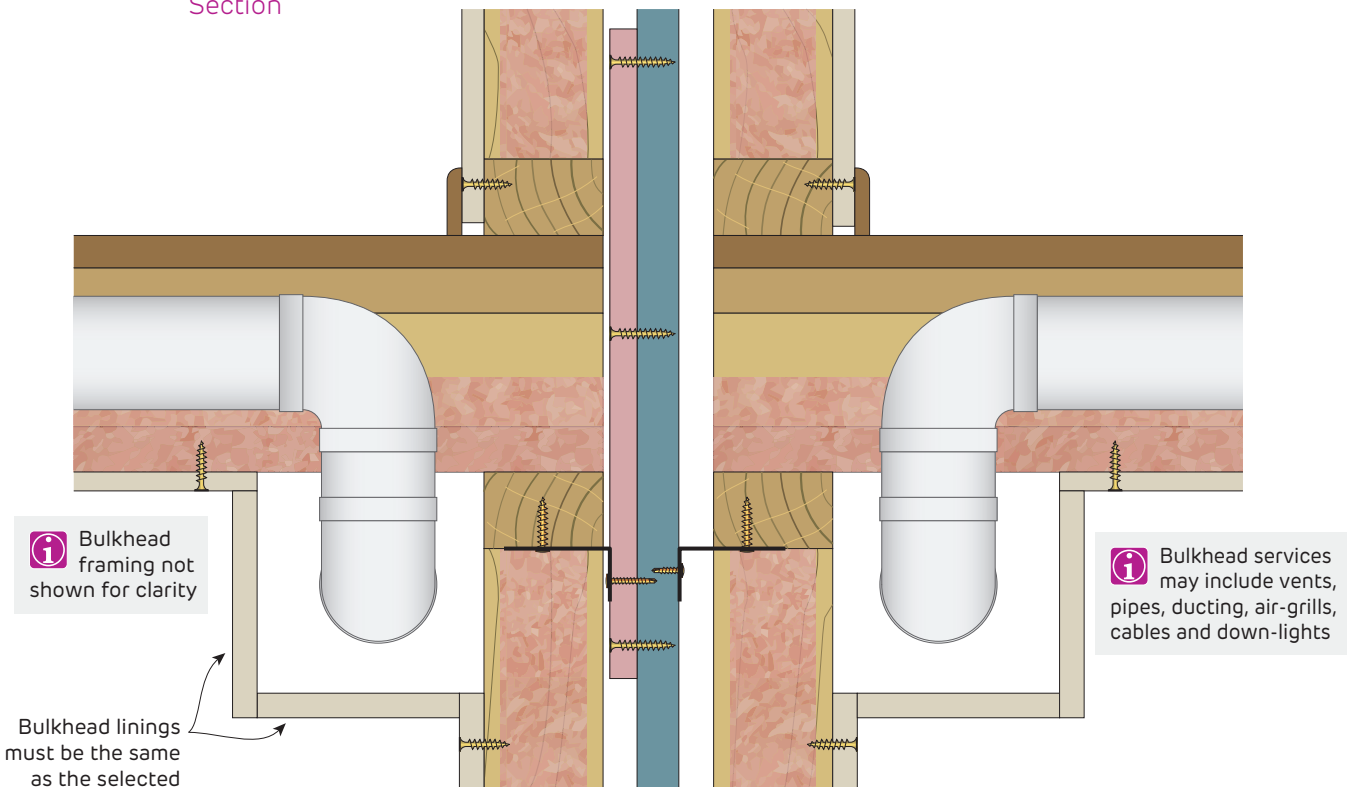

FIGURE 31 Interhome Wall with Bulkhead for Services
FRL 60/60/60
Section



Fire Rated

Interhome Wall To Upper Storey Staggered Floors

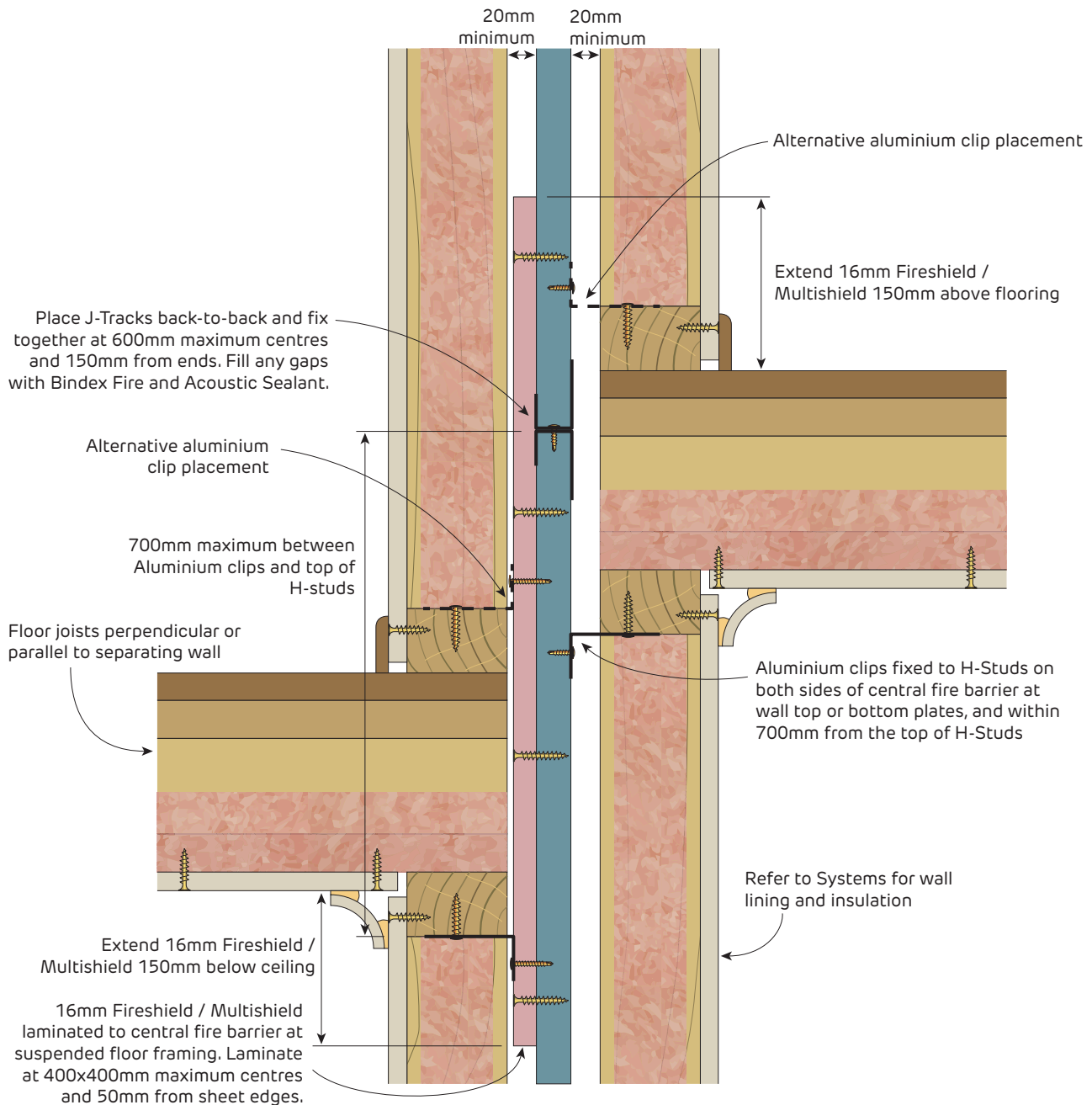

FIGURE 32 Interhome Wall to Upper Storey Staggered Floor
 FRL 60/60/60
 Section

Fire Rated Interhome Wall With Integrated Structural Members

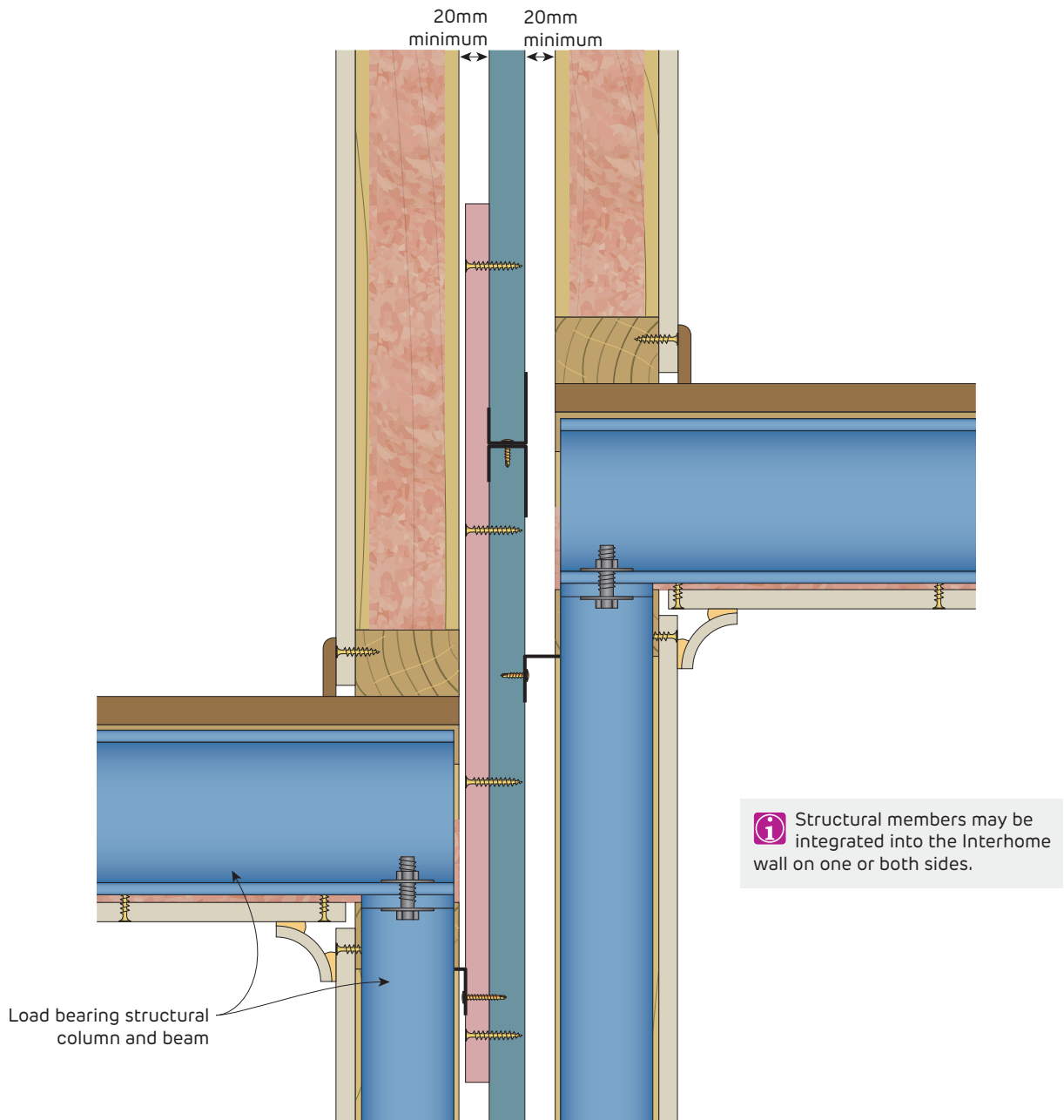

FIGURE 33 Interhome Wall with Integrated Structural Members
FRL 60/60/60
Section



Fire Rated

Interhome Wall to Upper Storey Floors When Distance To Top Of H-Stud And Bottom Plate Is Above 700mm

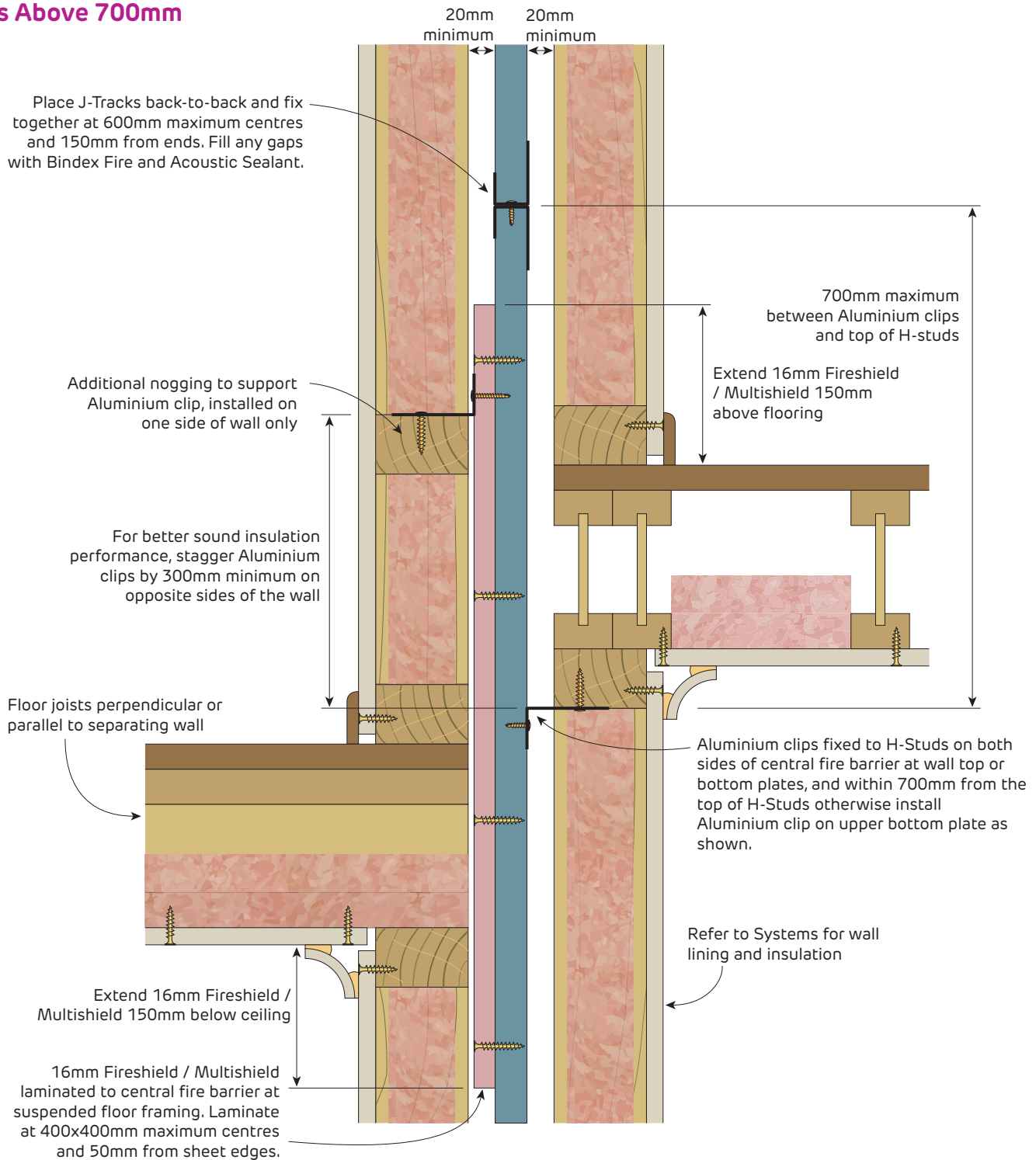

FIGURE 34 Interhome Wall to Upper Storey Staggered Floor with additional Noggings installed
 FRL 60/60/60
 Section

Fire Rated
Interhome Wall To Roof Lining

i Also refer to Figures 41 and 43 before building

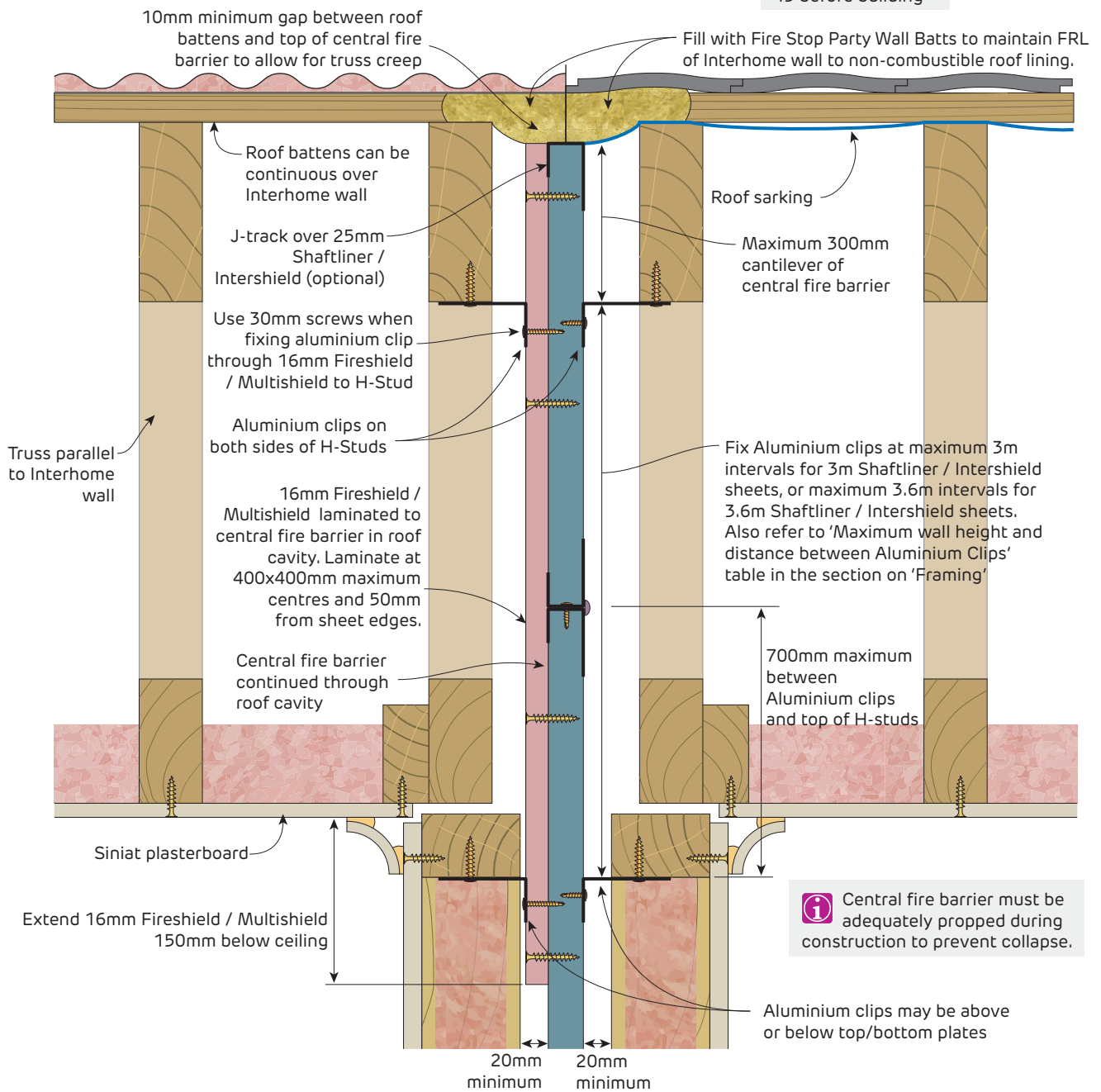

FIGURE 35 Interhome Wall to Roof Lining
FRL 60/60/60
Section



Fire Rated Interhome Wall To Roof Lining

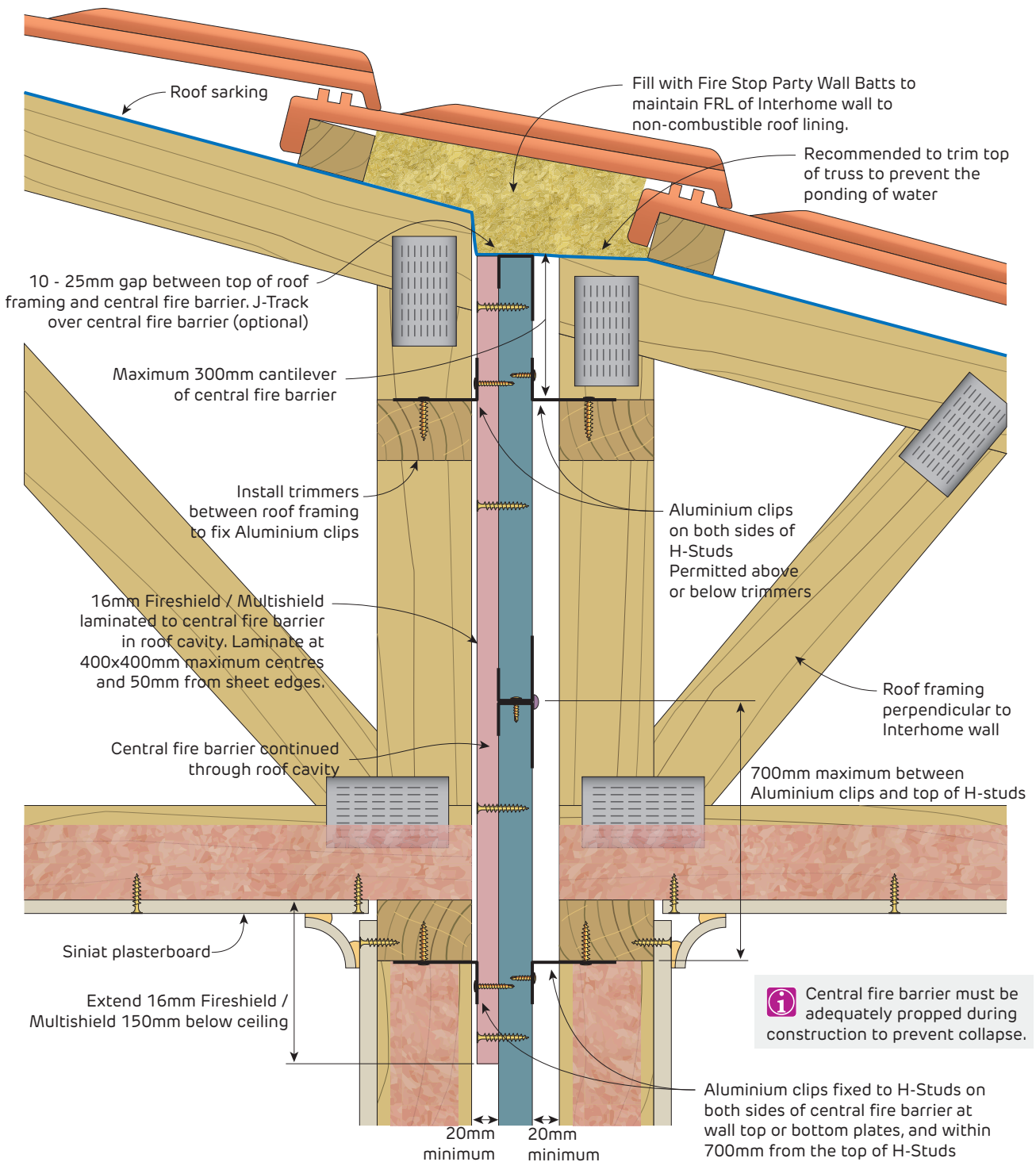

FIGURE 36 Interhome Wall to Roof Lining
FRL 60/60/60
Section

Fire Rated
Interhome Wall To Roof

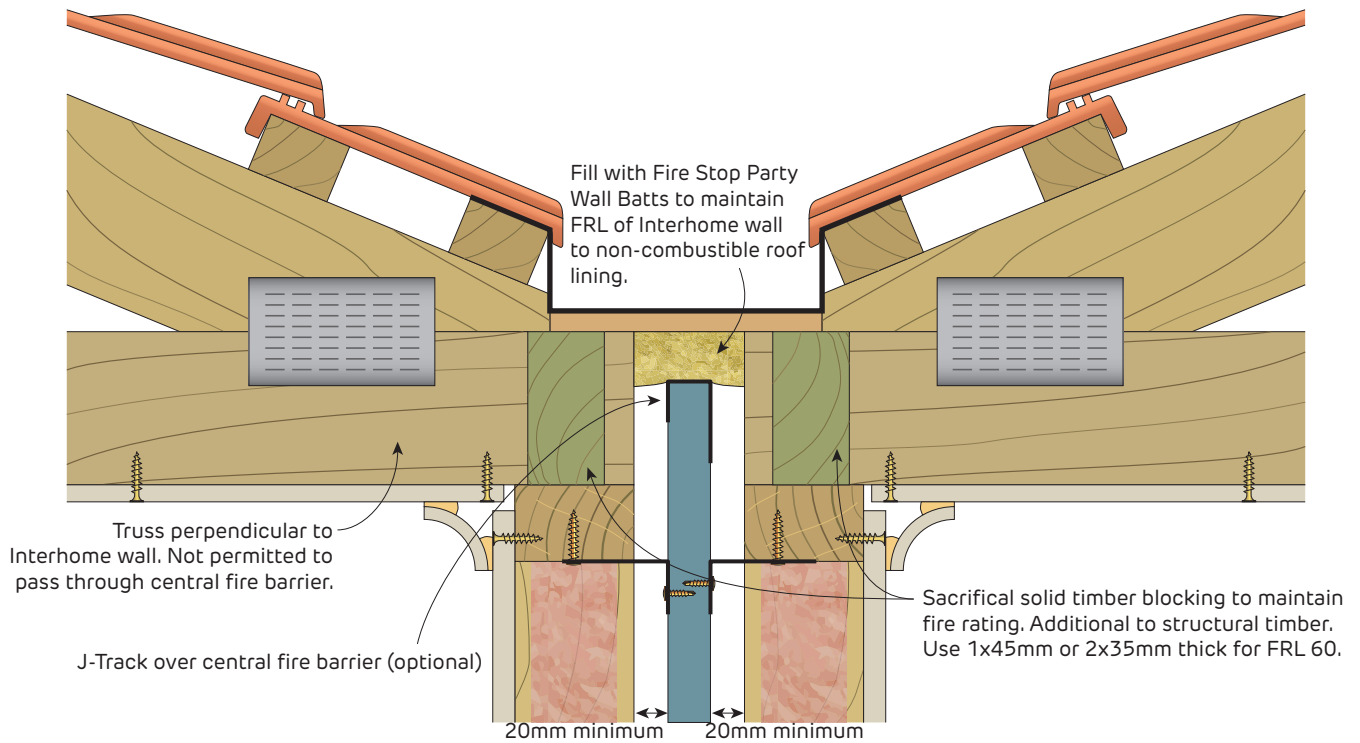

FIGURE 37 Interhome Wall to Box Gutter with Perpendicular Roof Trusses
Timber Frame - FRL 60/60/60
Section

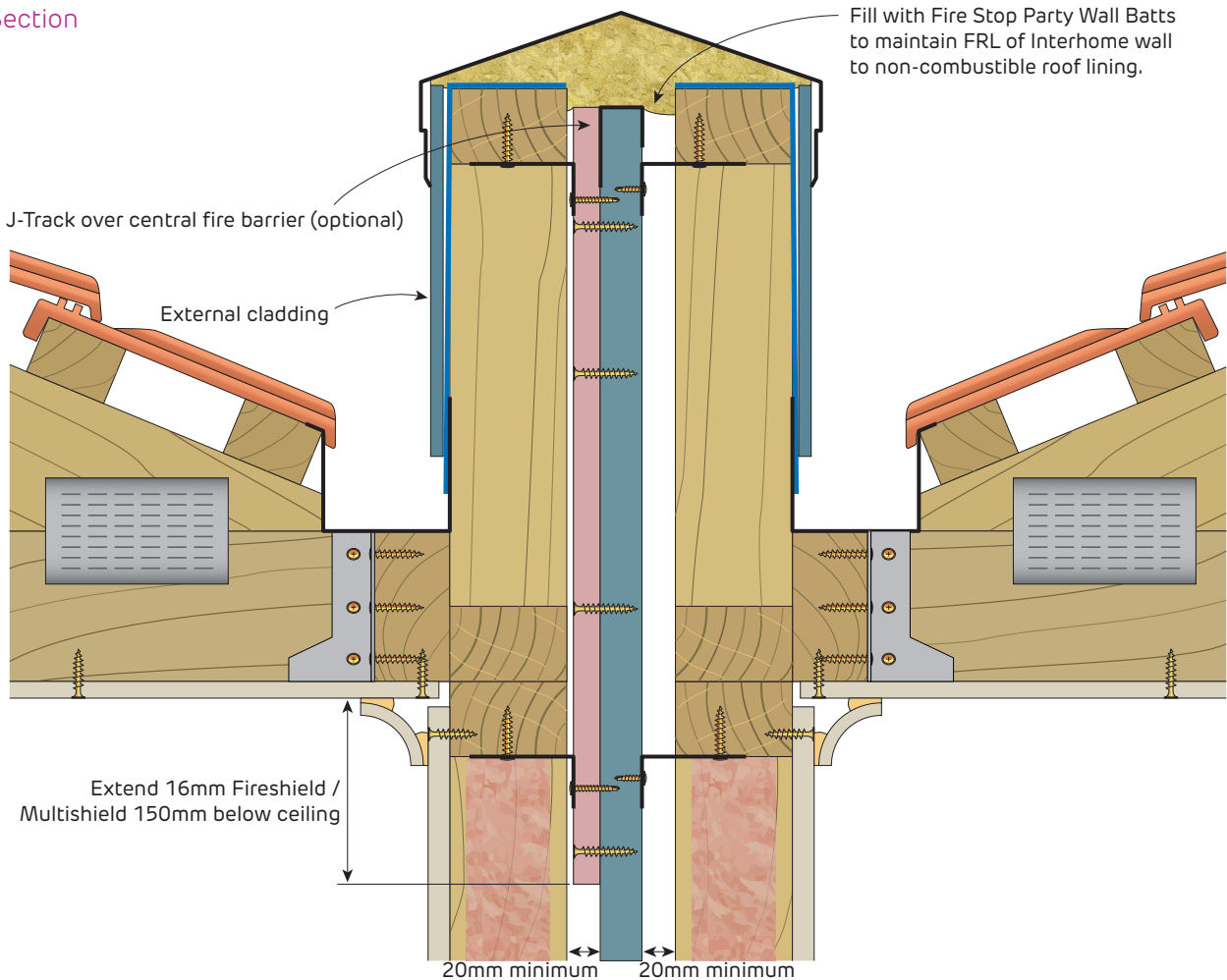

FIGURE 38 Interhome Wall to Parapet Roof with Perpendicular Roof Trusses
FRL 60/60/60
Section



Fire Rated

Interhome Central Fire Barrier

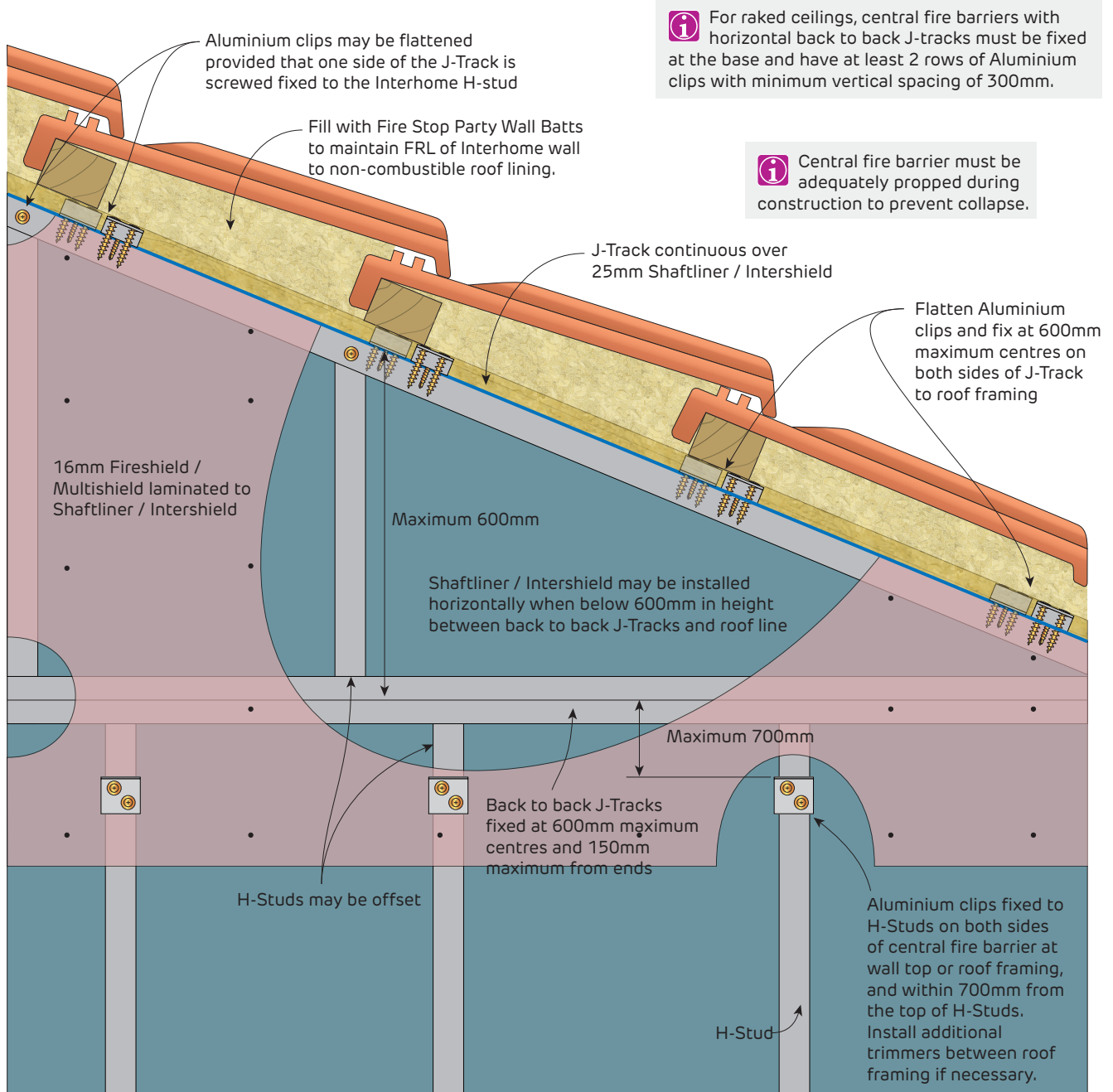

FIGURE 39 Interhome with Horizontal Shaftliner / Intershield panels under Roof Line

FRL 60/60/60

Section

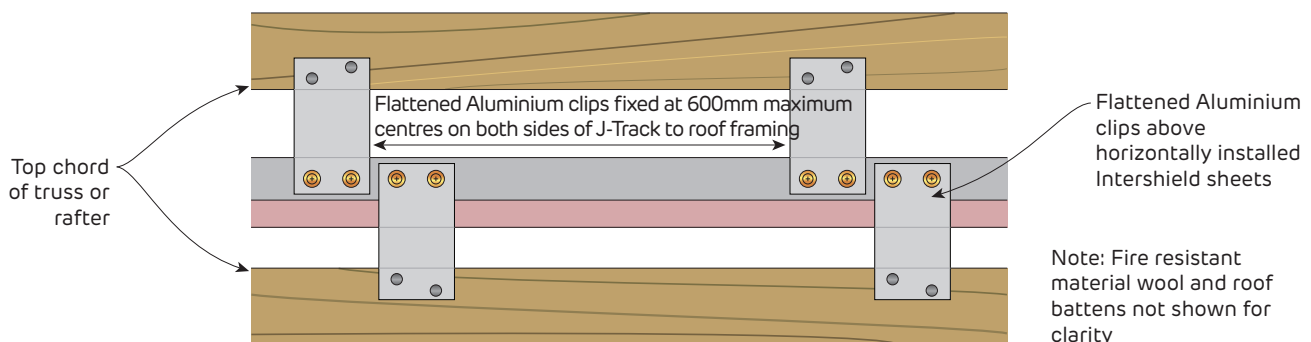

FIGURE 40 Interhome with Flattened Aluminium Clips over Horizontally Installed Shaftliner / Intershield

FRL 60/60/60

Section

Fire Rated
Interhome Central Fire Barrier

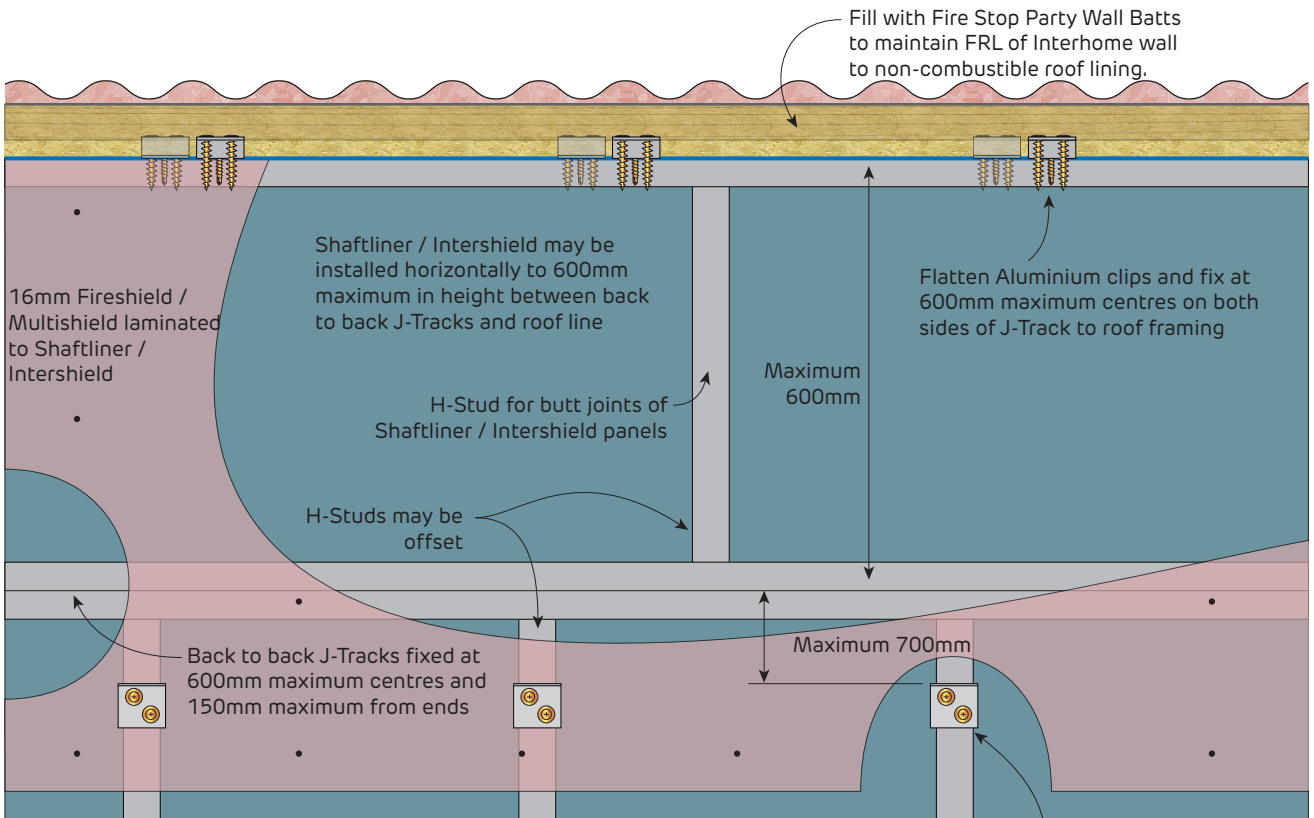

FIGURE 41 Interhome with Horizontal Shaftliner / Intershield panels under Roof Line
FRL 60/60/60
Section

Aluminium clips fixed to H-Studs on both sides of central fire barrier at wall top or roof framing, and within 700mm from the top of H-Studs. Install additional trimmers between roof framing if necessary.

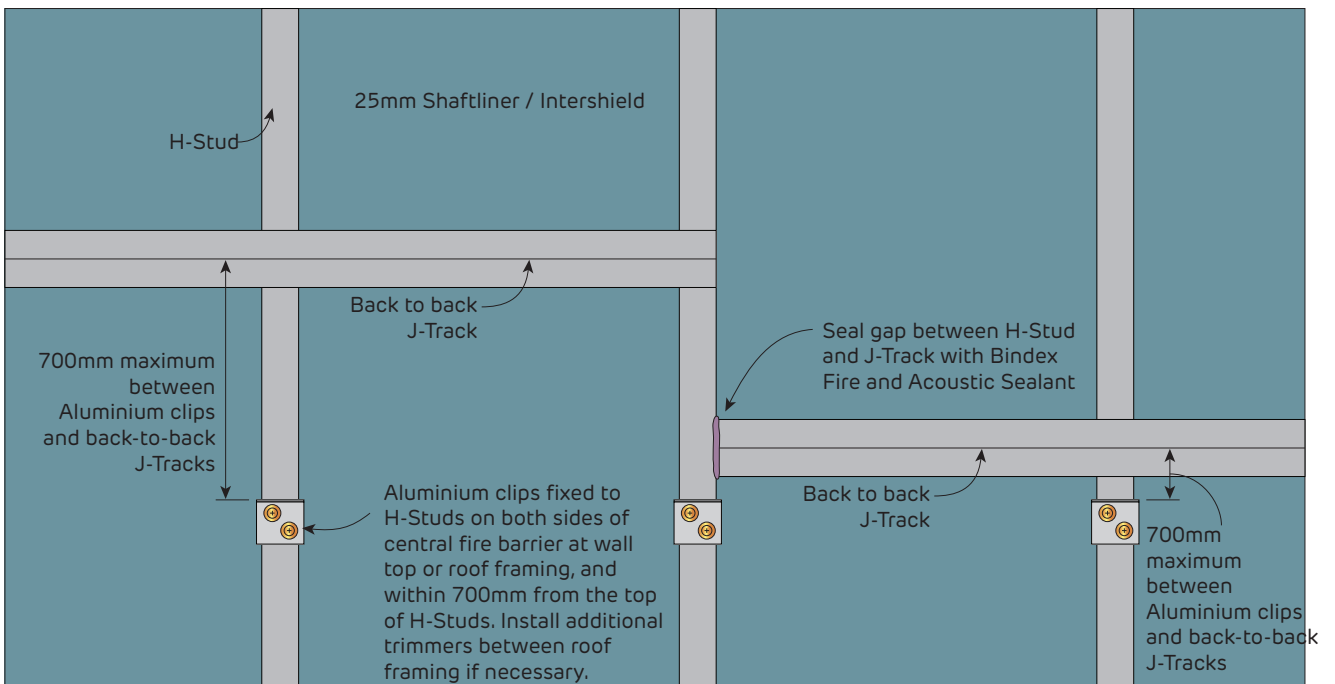

FIGURE 42 Interhome with Step-Down in Slab
FRL 60/60/60
Section

Fill any gaps with Bindex fire and acoustic sealant to maintain integrity



Fire Rated Interhome Wall Over Eaves

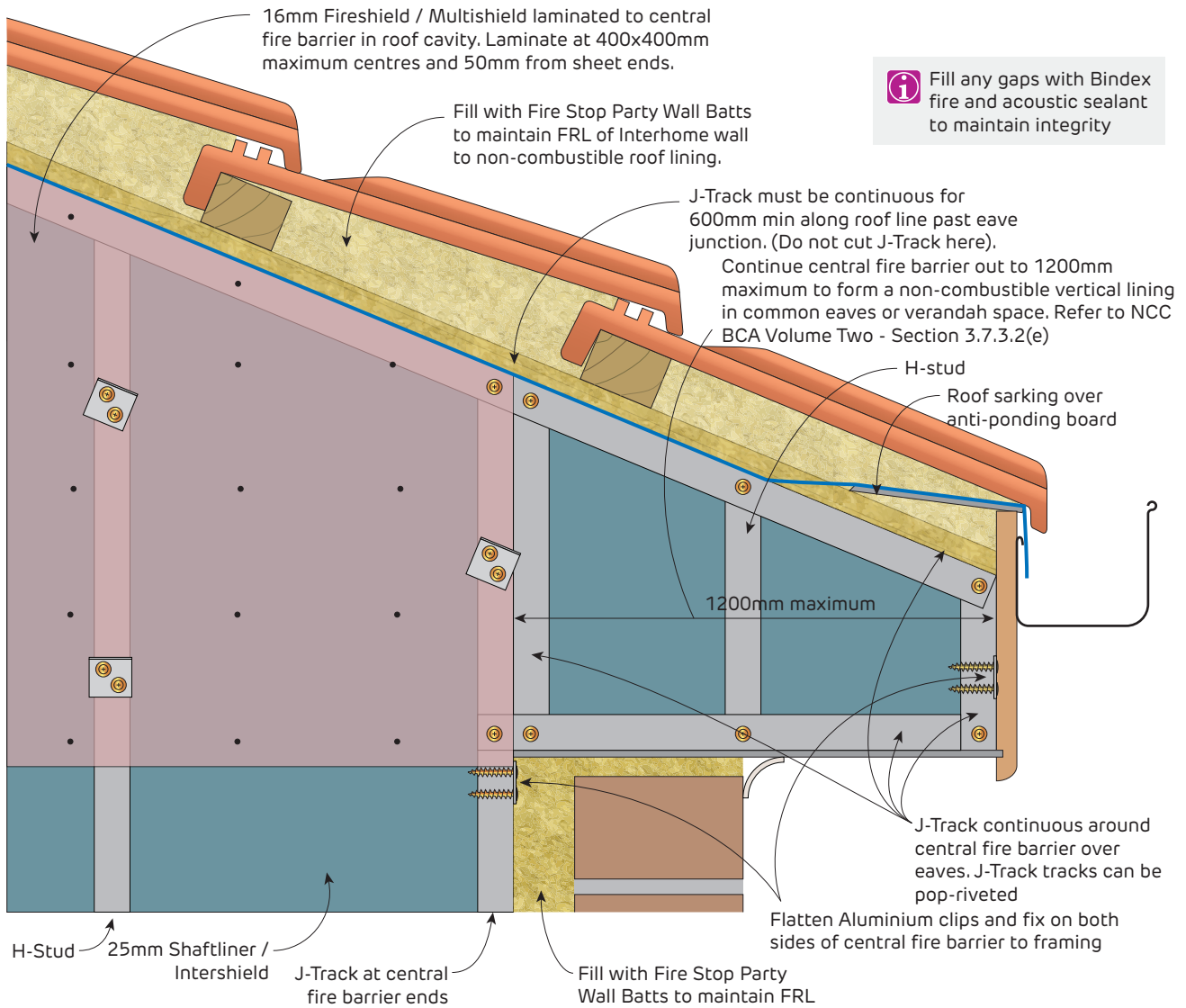

FIGURE 43 Interhome over Eaves

FRL 60/60/60

Section

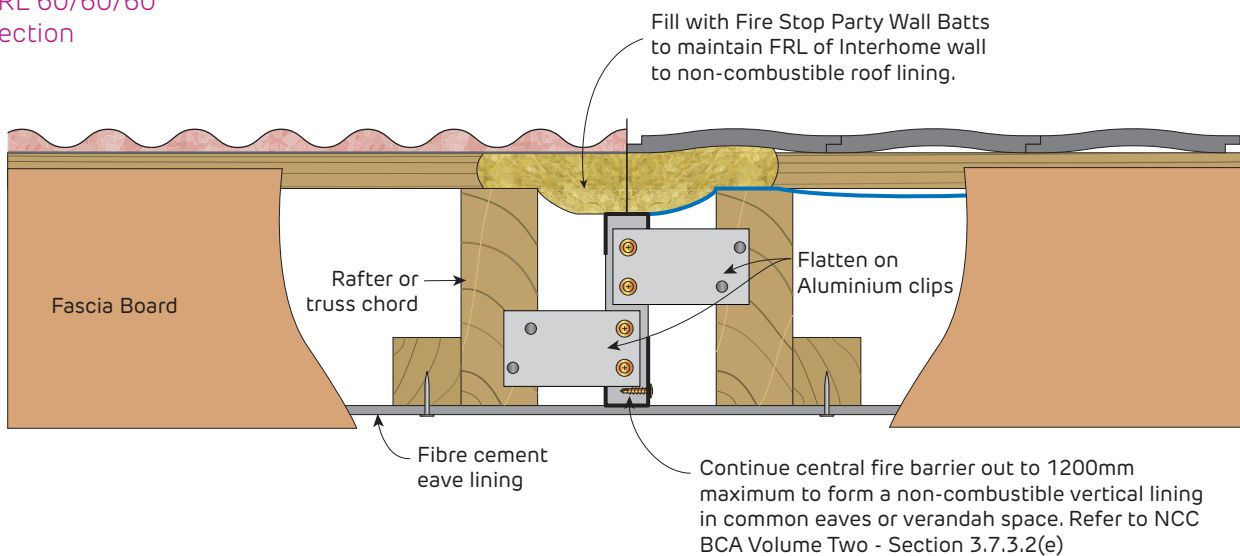

FIGURE 44 Interhome over Eave End Detail for Class 1 Buildings

FRL 60/60/60

Section

Fire Rated

Interhome Wall Over Common Eave Or Verandah Space

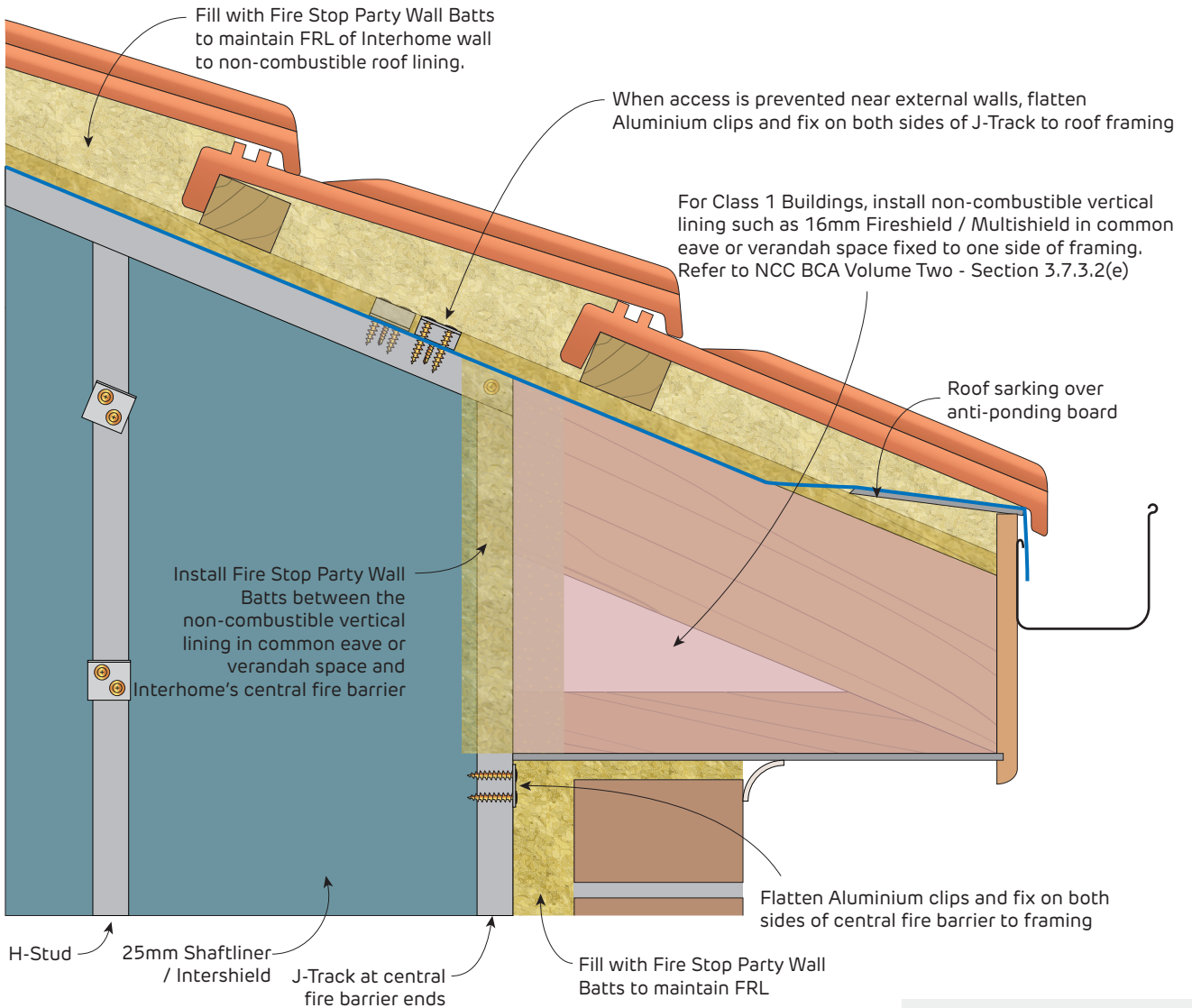

FIGURE 45 Interhome over Common Eave or Verandah Space

FRL 60/60/60

Section

i Fill any gaps with Bindex fire and acoustic sealant to maintain integrity

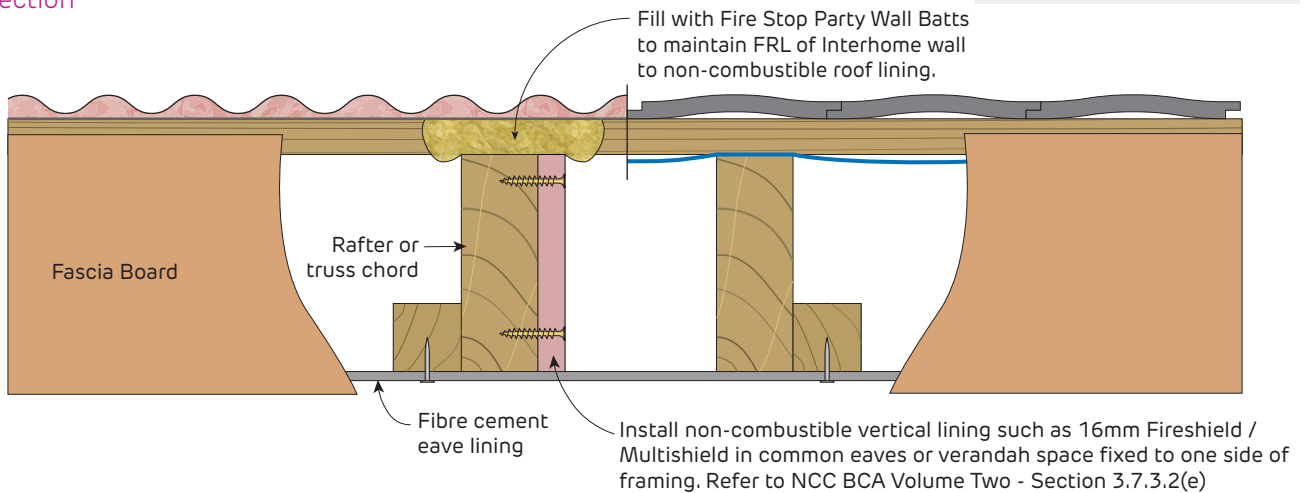

FIGURE 46 Interhome over Eave End Detail for Class 1 Buildings

FRL 60/60/60

Section



Fire Rated

Interhome Wall To External Wall Above

1 layer of 16mm Multishield to maintain FRL 60/60/60 of the external wall above the Interhome separating wall (System TSW473, SSW473, TSW483, SSW483)

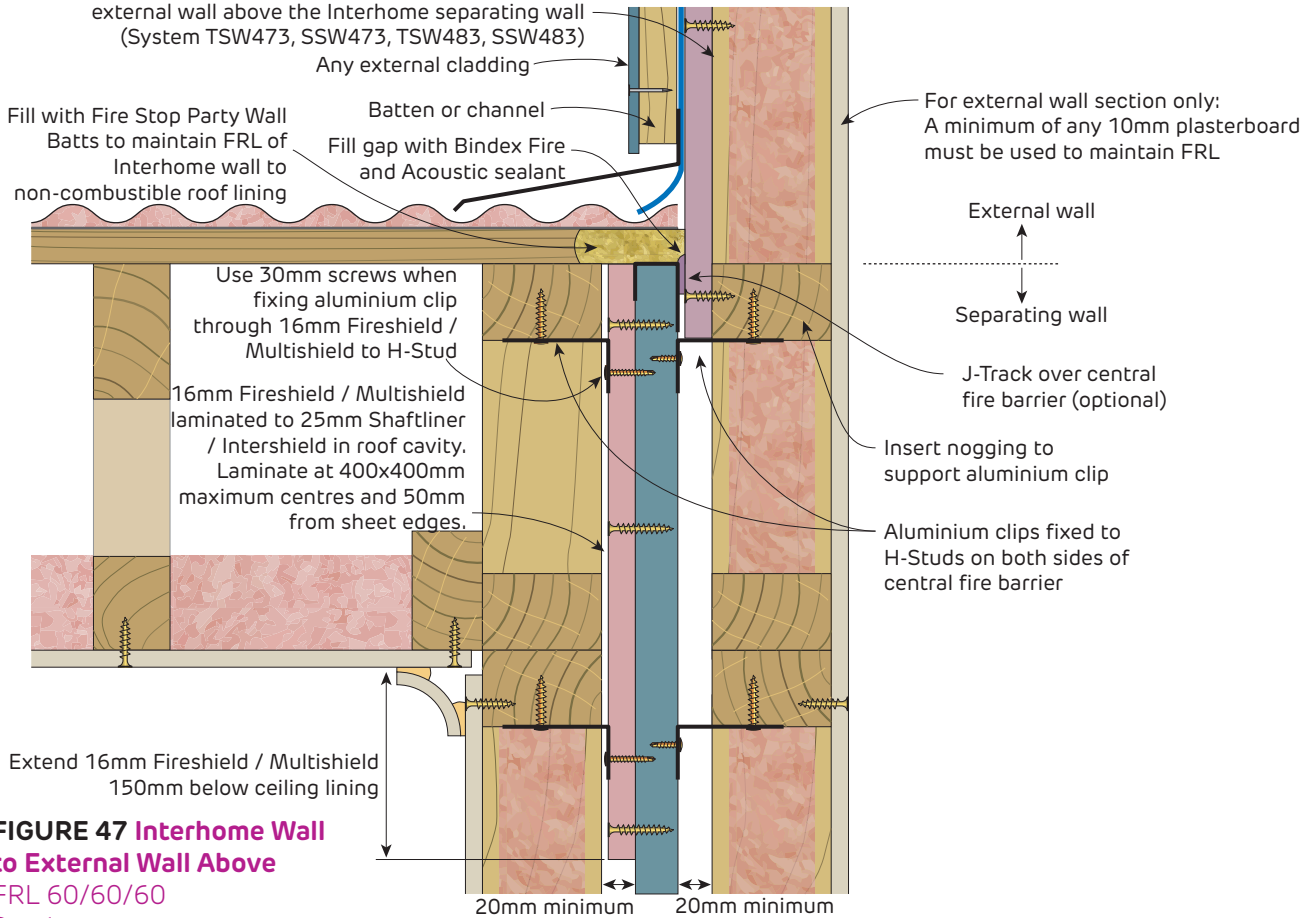

FIGURE 47 Interhome Wall to External Wall Above
FRL 60/60/60
Section

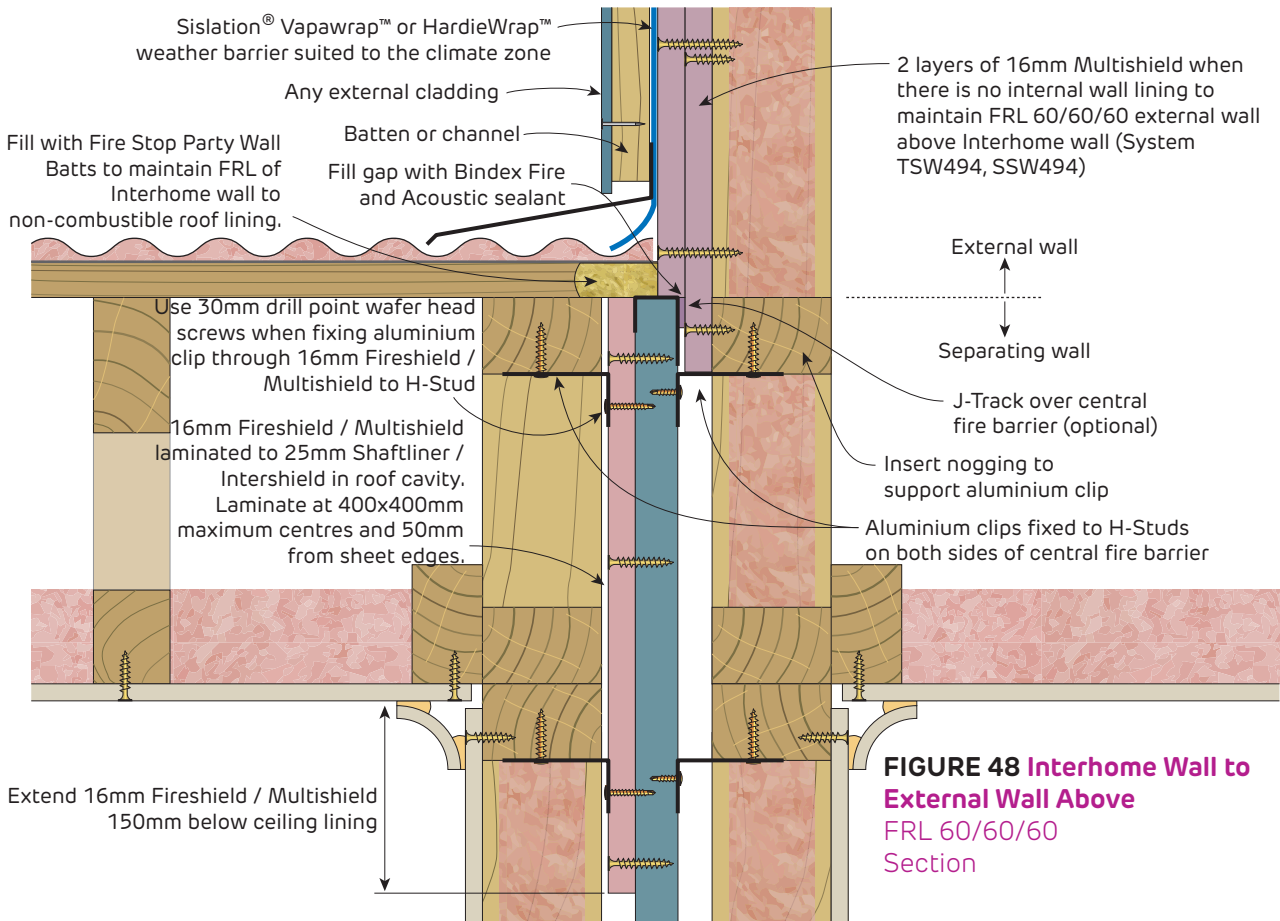

FIGURE 48 Interhome Wall to External Wall Above
FRL 60/60/60
Section

Fire Rated

Interhome Wall To External Wall Above With Eave Overhanging Boundary

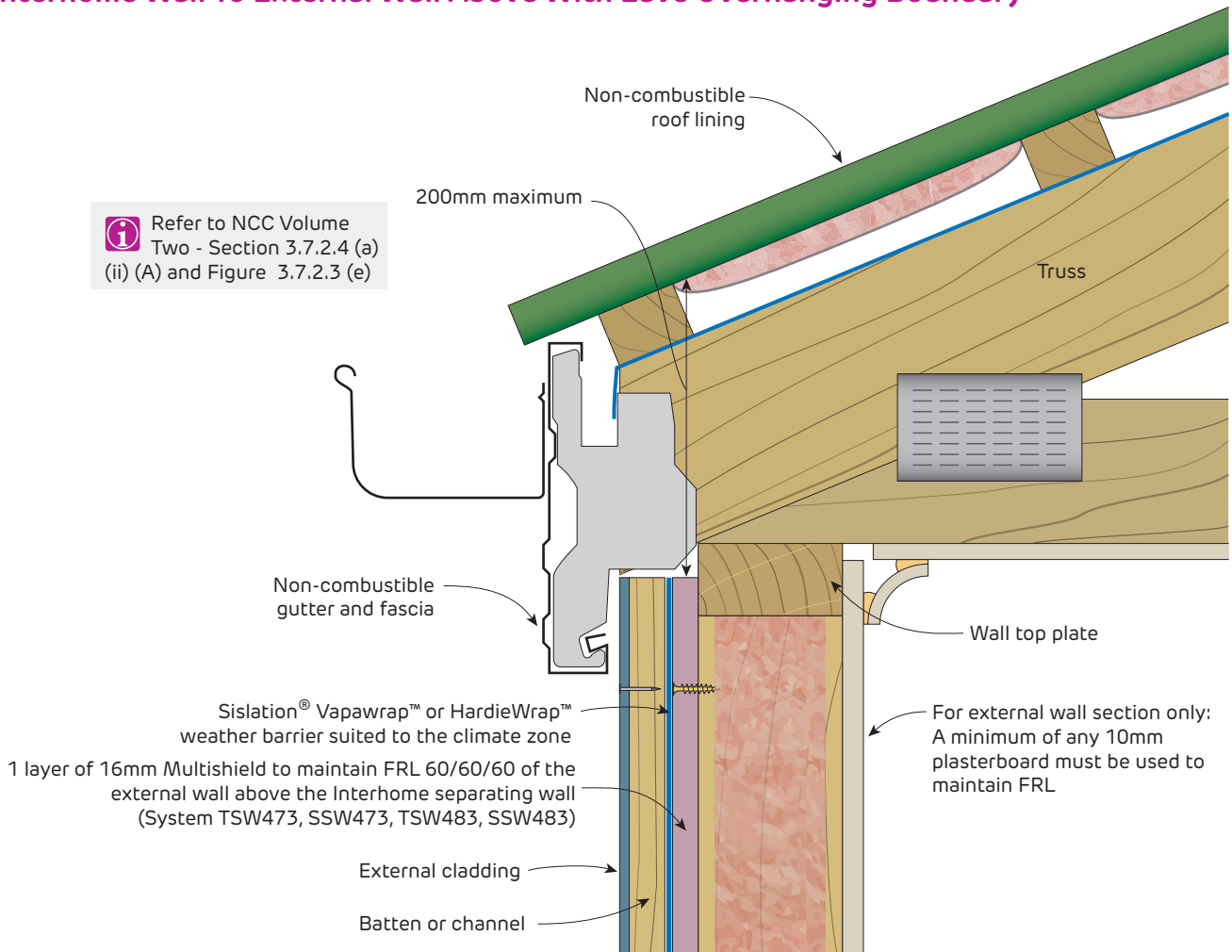

FIGURE 49 Interhome over Eaves - NCC Acceptable Construction Practice Option 1

FRL 60/60/60
Section

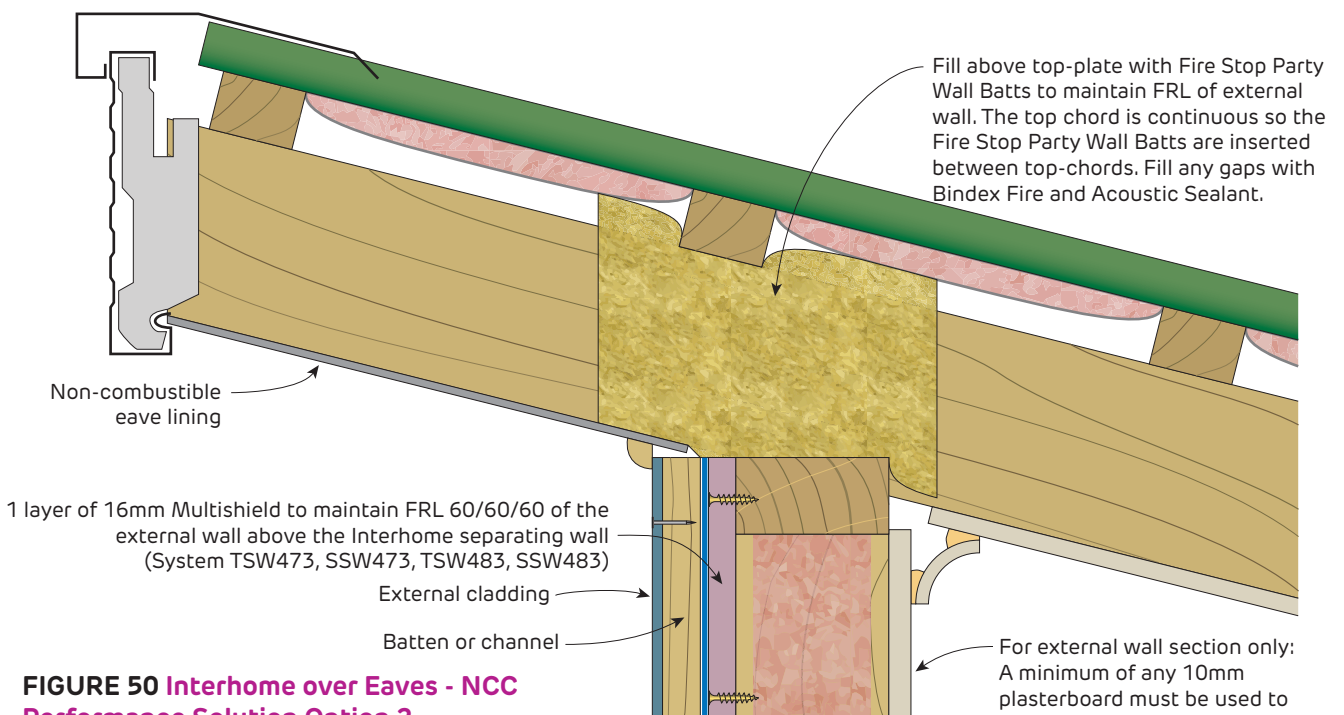

FIGURE 50 Interhome over Eaves - NCC Performance Solution Option 2

Timber Frame - FRL 60/60/60 Section



Fire Rated

Interhome Wall To External Wall Above With Eave Overhanging Boundary

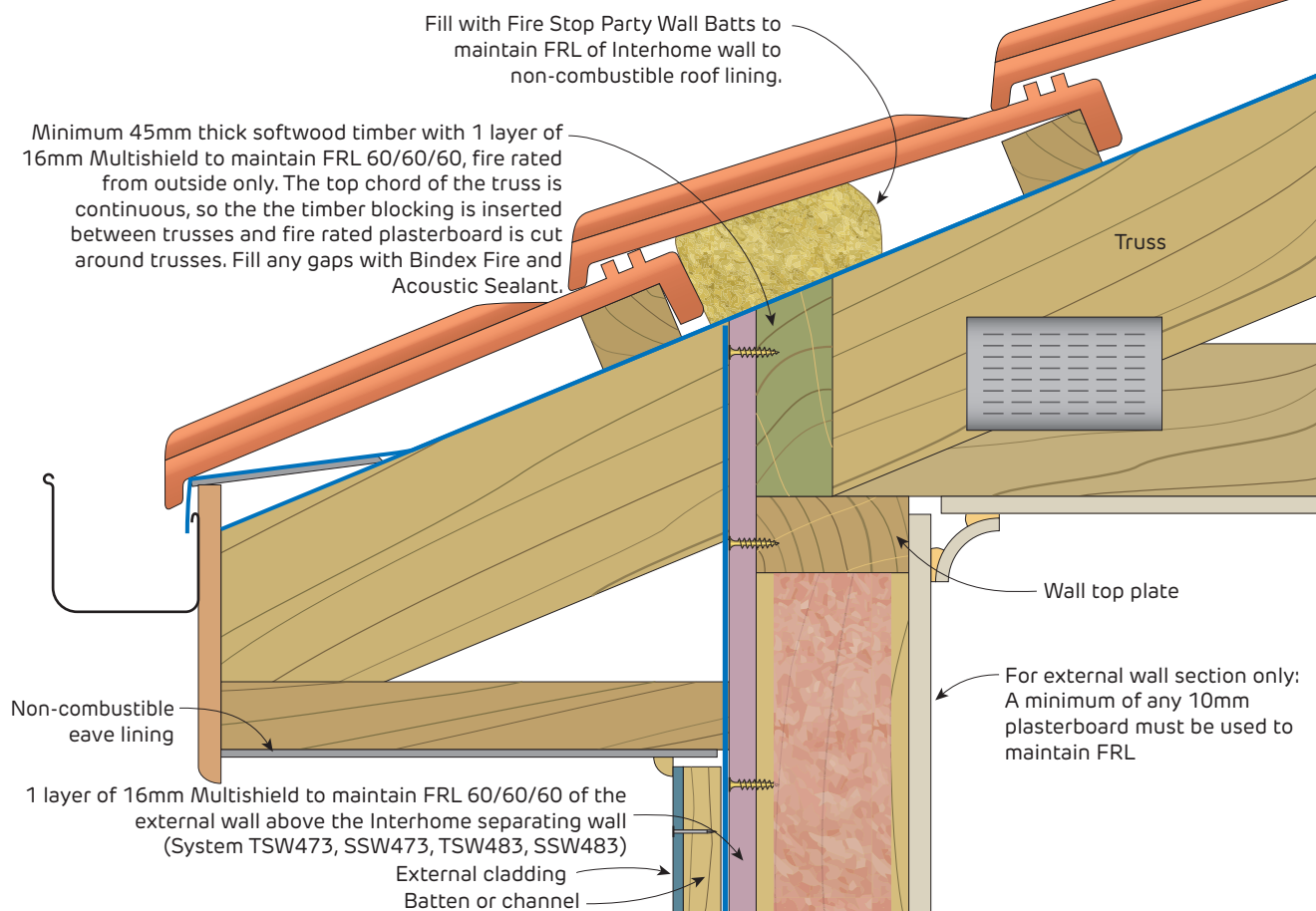

FIGURE 51 Interhome over Eaves - NCC Performance Solution Option 3

Timber Frame - FRL 60/60/60
Section

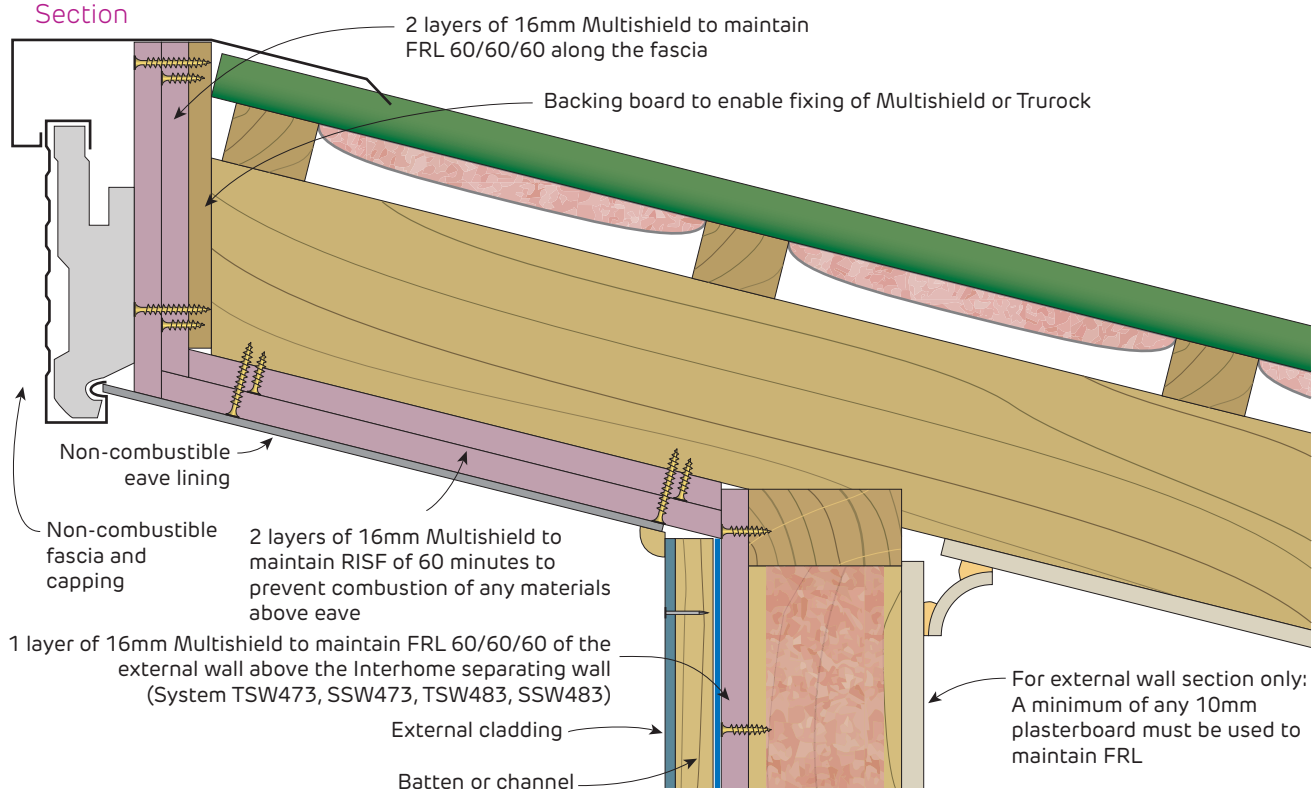

FIGURE 52 Interhome over Eaves - NCC Performance Solution Option 4

FRL 60/60/60 with RISF 60 Eave
Section

Fire Rated
Interhome Wall To External Wall Above

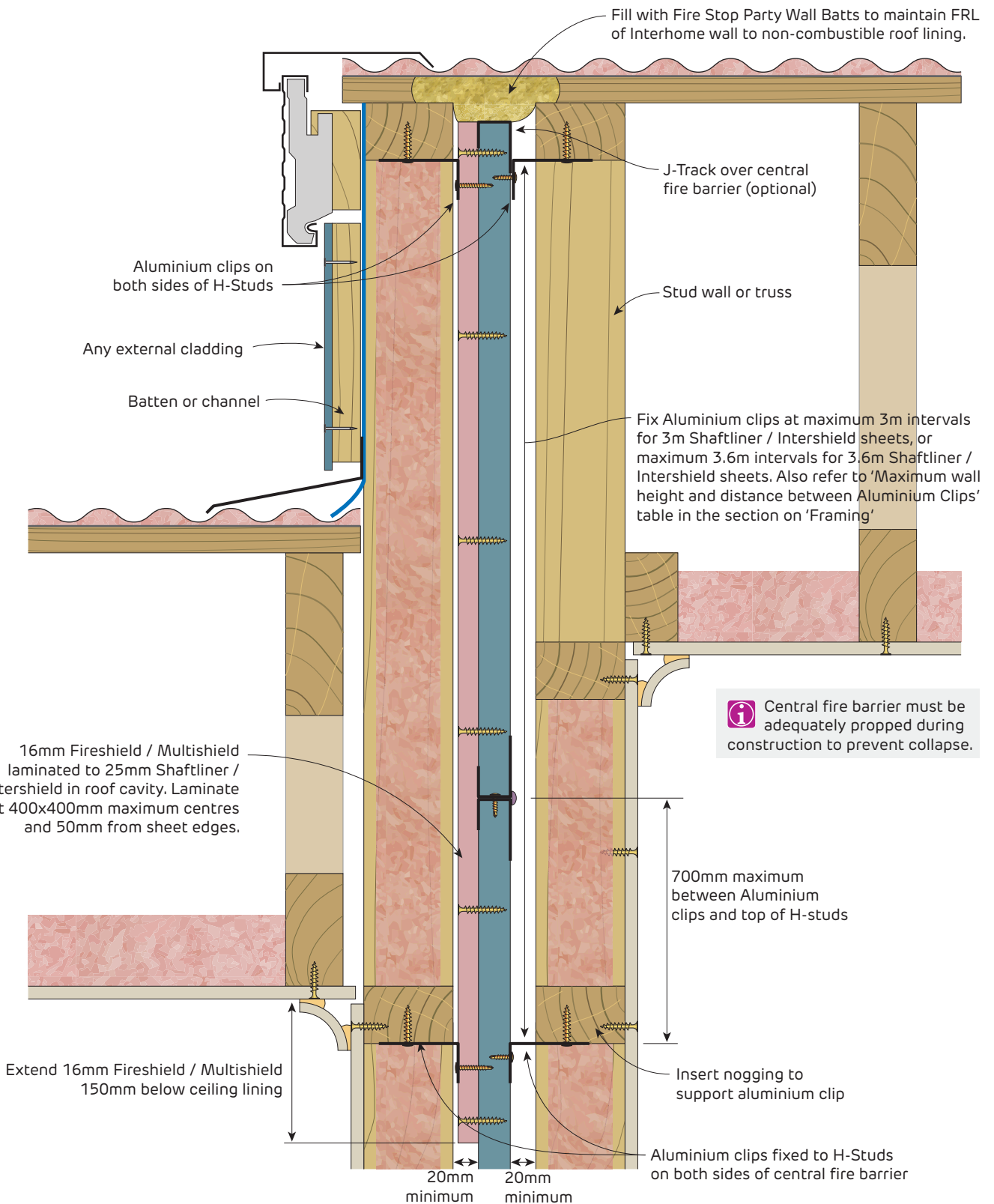

FIGURE 53 Interhome Wall to External Wall Above
FRL 60/60/60
Section



Fire Rated Interhome Junctions

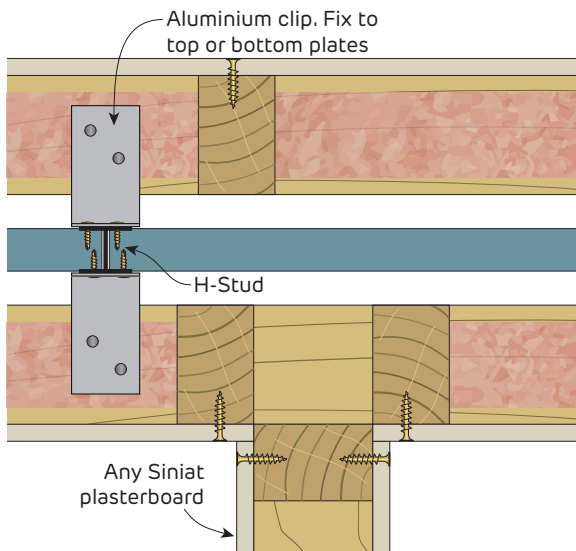

FIGURE 57 Interhome Wall with Non-Fire Rated Intersecting Wall
Timber Frame - FRL 60/60/60
Plan

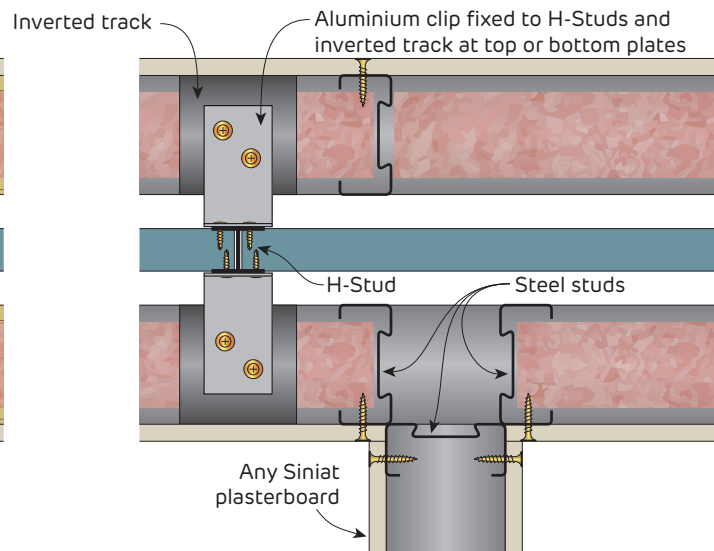

FIGURE 55 Interhome Wall with Non-Fire Rated Intersecting Wall
Steel Frame - FRL 60/60/60
Plan

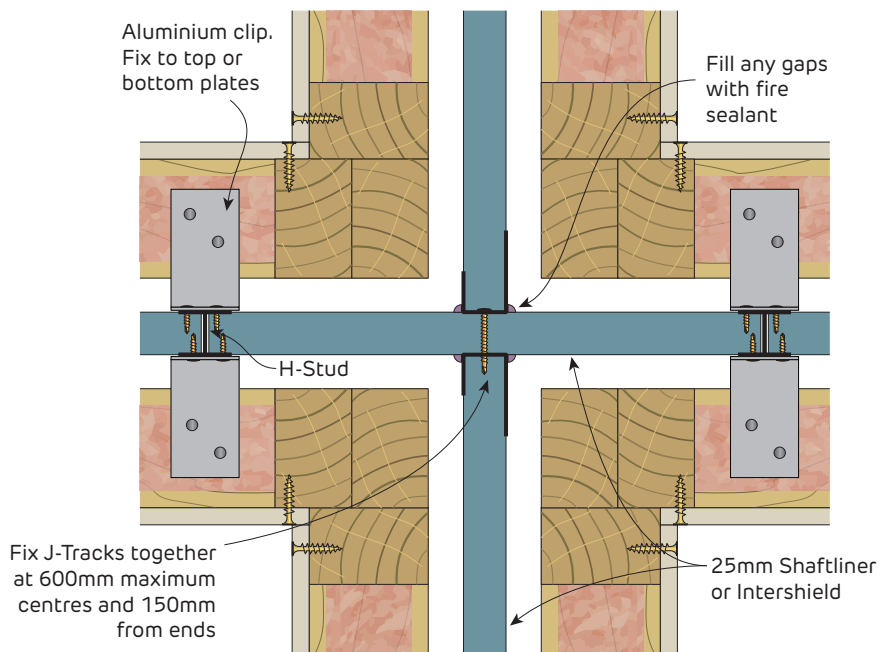

FIGURE 56 Interhome Wall Intersection
FRL 60/60/60
Plan

**Fire Rated
Interhome Junctions**

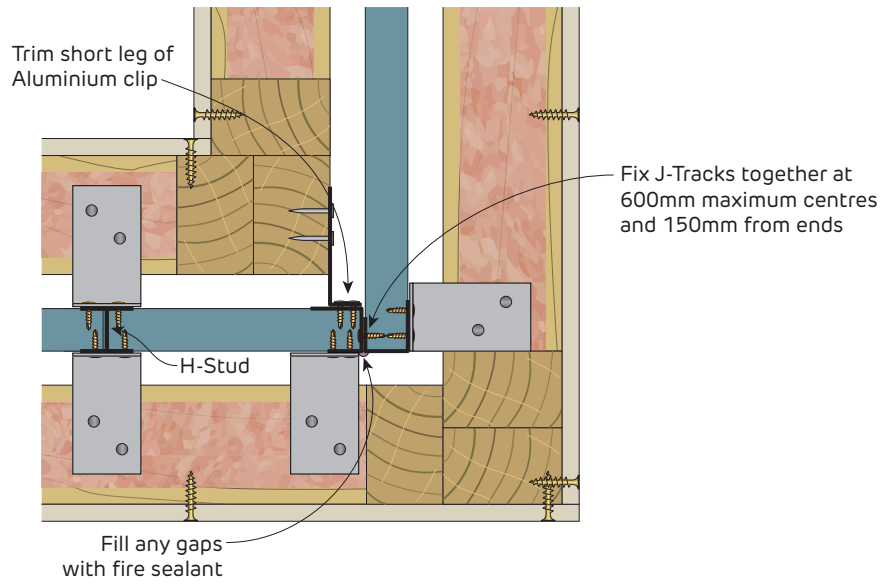

FIGURE 57 Interhome Wall Corner
FRL 60/60/60
Plan

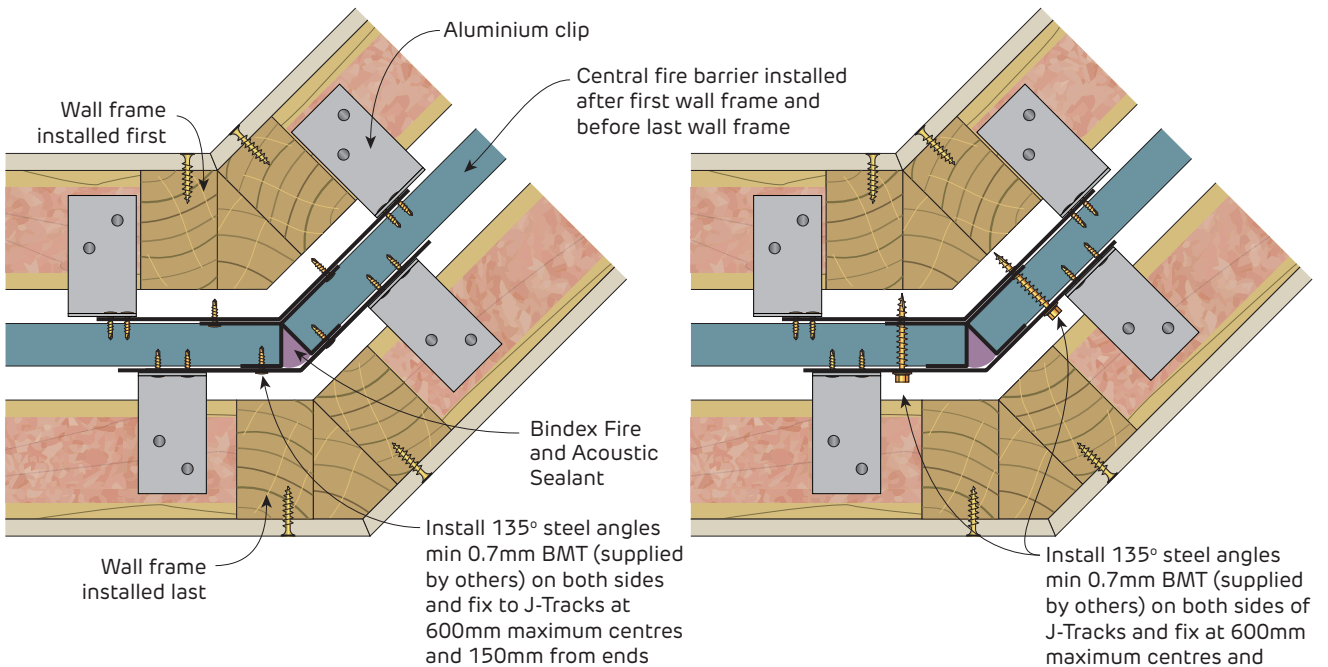

FIGURE 58 Interhome Wall Obtuse Angle Corner
FRL 60/60/60
Plan

FIGURE 59 Interhome Wall Obtuse Angle Corner
Retrofit detail - FRL 60/60/60
Plan



Fire Rated Interhome Wall To External Wall

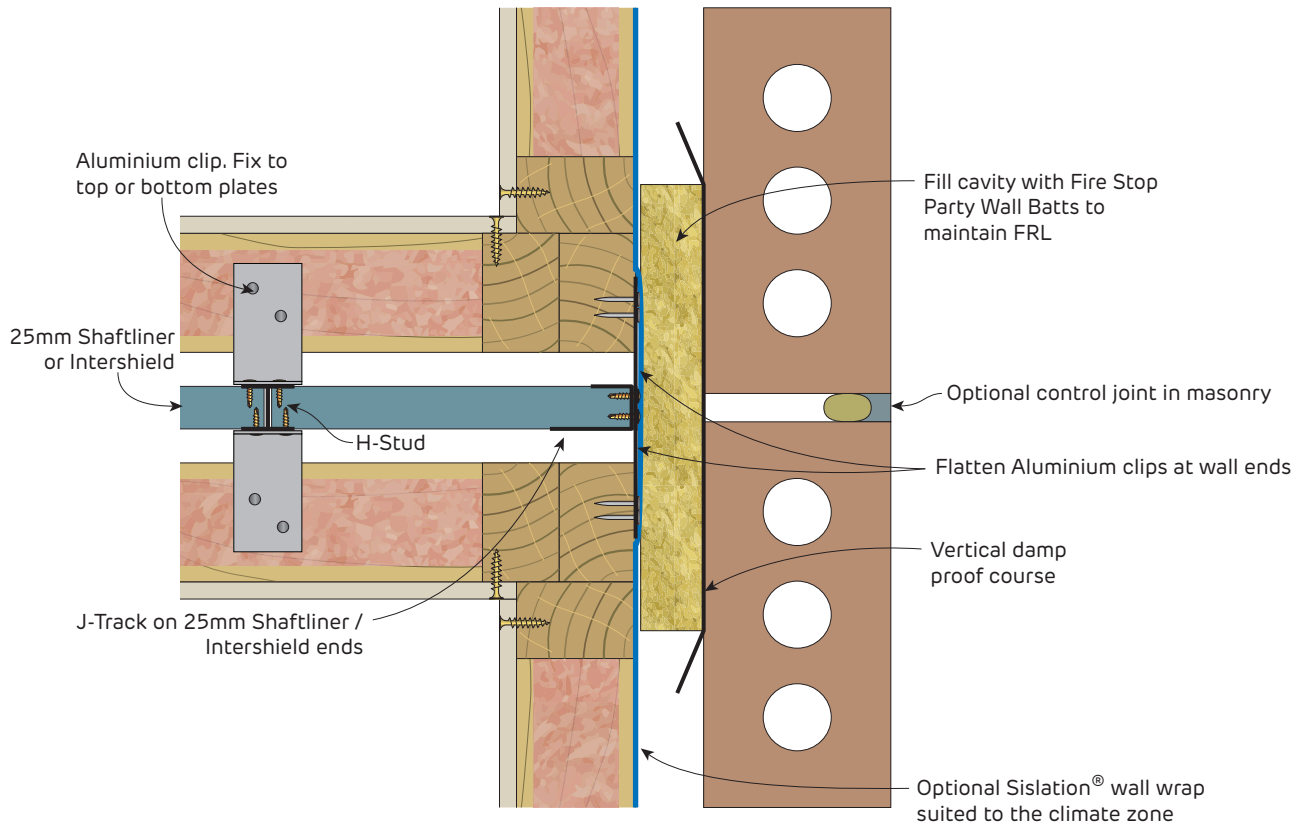

FIGURE 60 Interhome Wall to External Brick Wall
Timber Frame - FRL 60/60/60
Plan

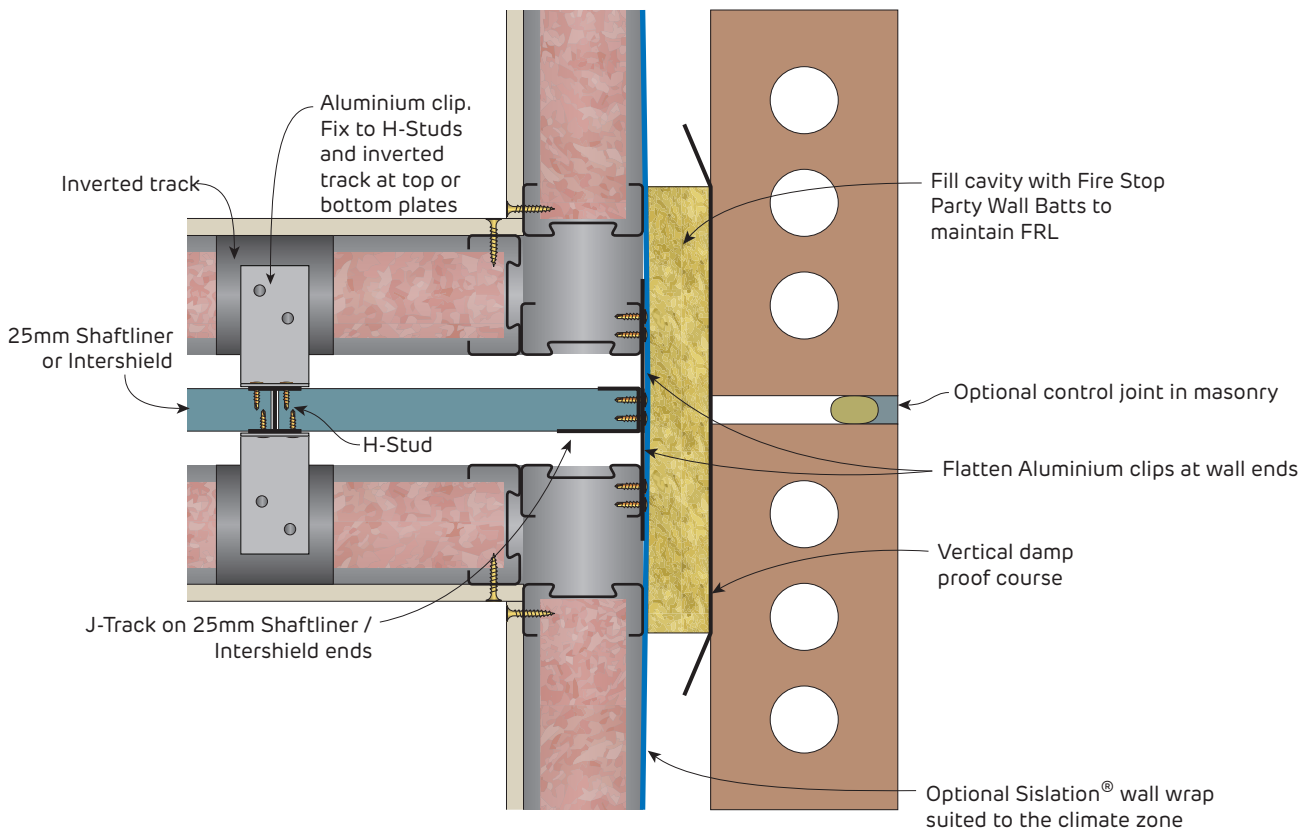

FIGURE 61 Interhome Wall to External Brick Wall
Steel Frame - FRL 60/60/60
Plan

Fire Rated
Interhome Wall To External Wall

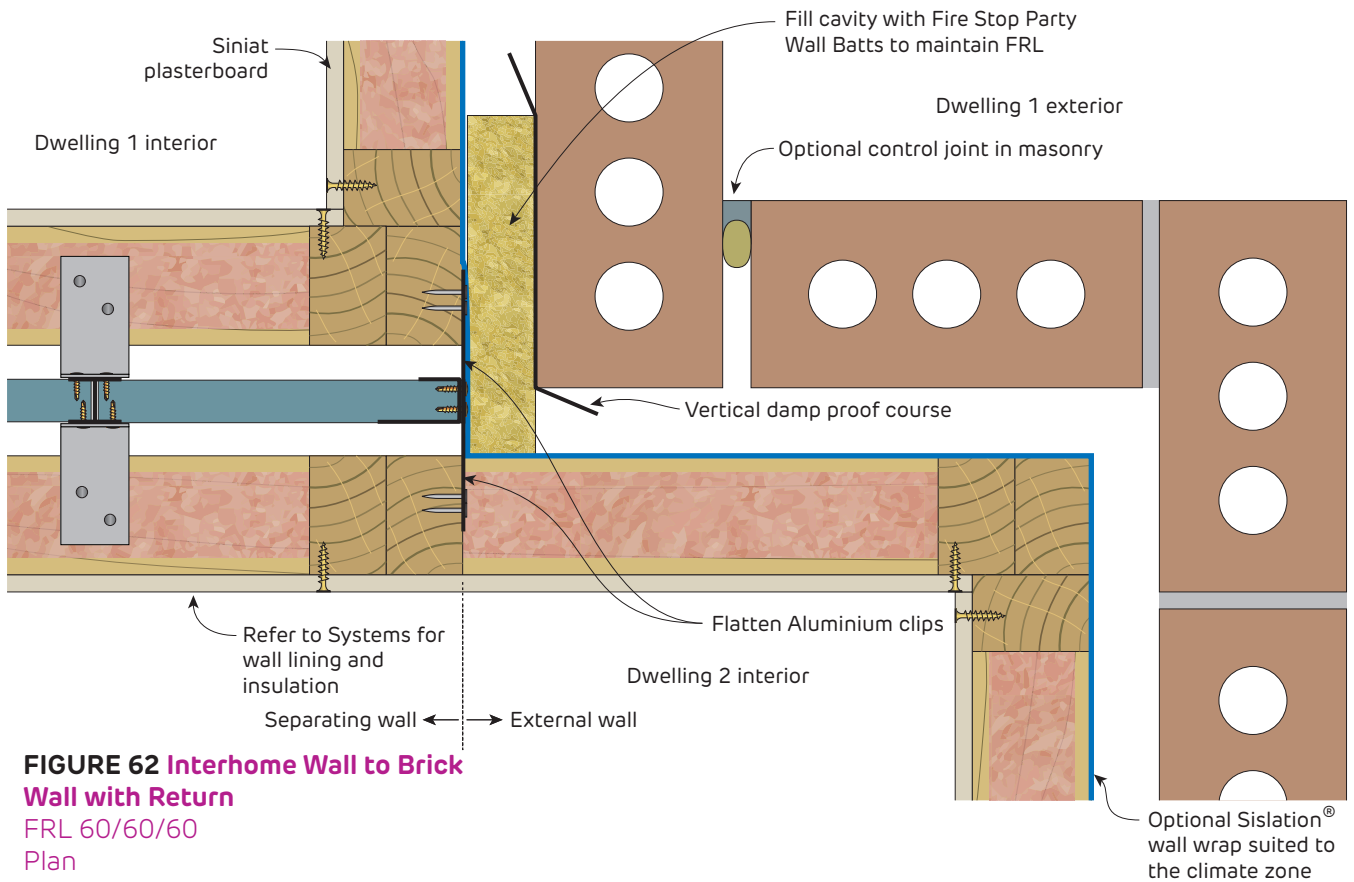

FIGURE 62 Interhome Wall to Brick Wall with Return
FRL 60/60/60
Plan

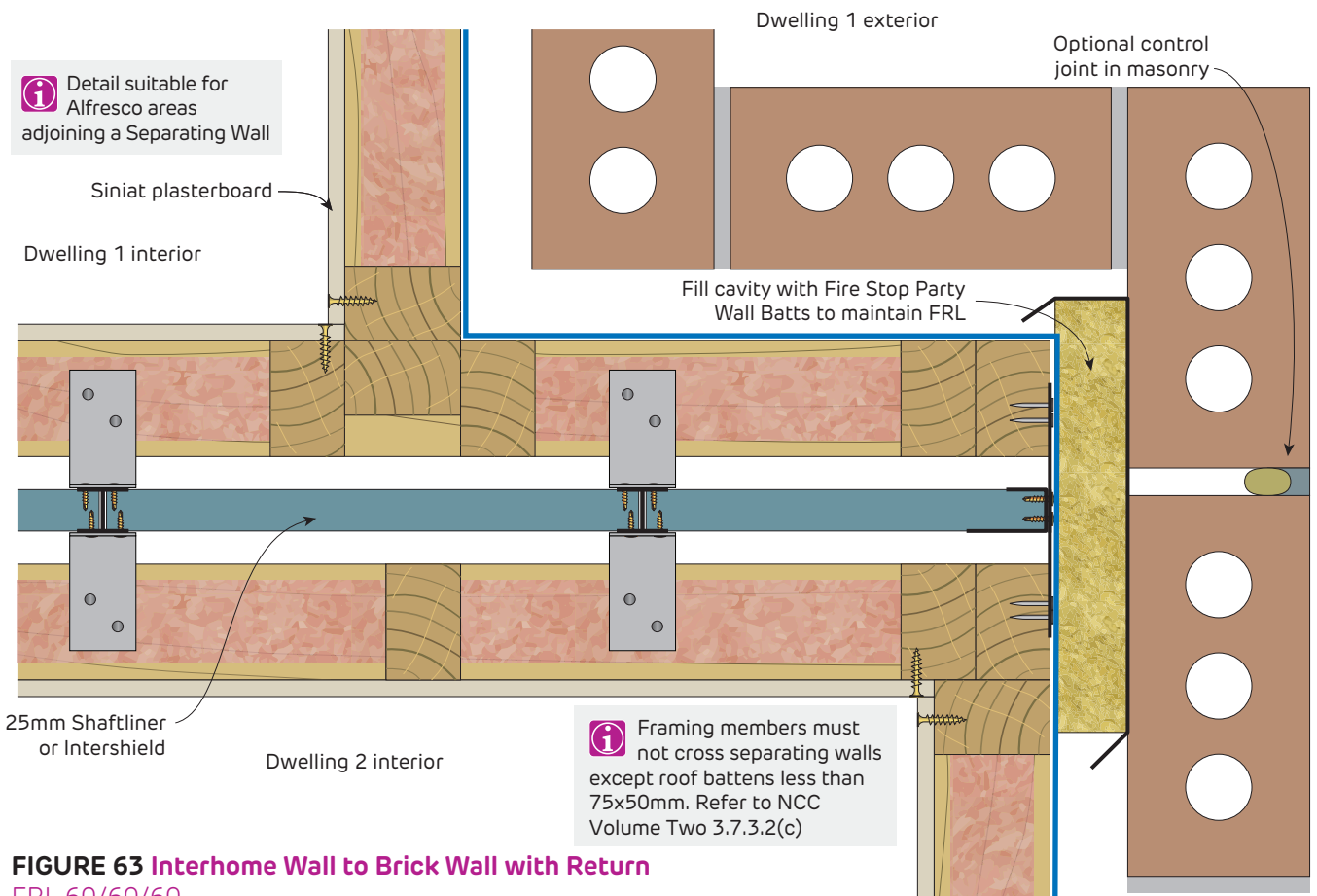

FIGURE 63 Interhome Wall to Brick Wall with Return
FRL 60/60/60
Plan



Fire Rated

Interhome Wall To External Wall

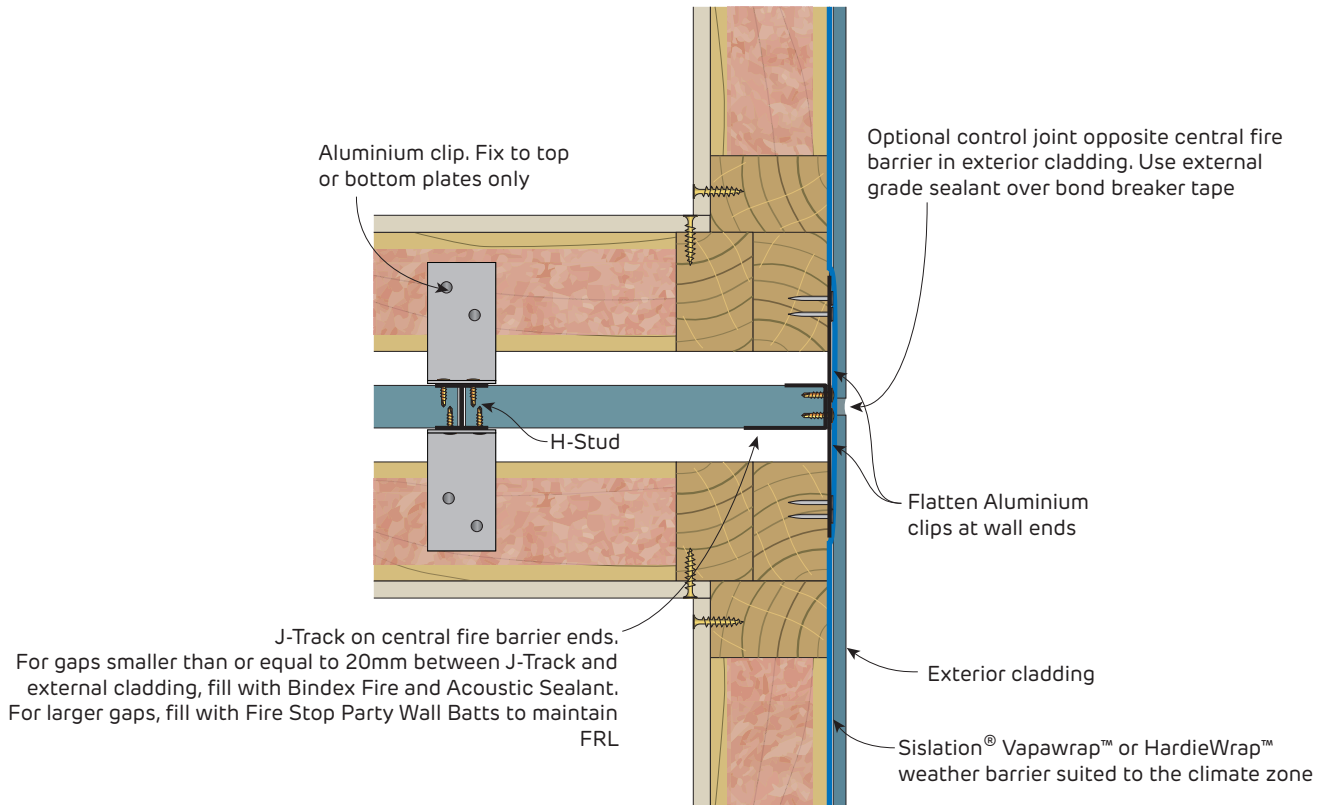

FIGURE 64 Interhome Wall to External Clad Wall

FRL 60/60/60

Plan

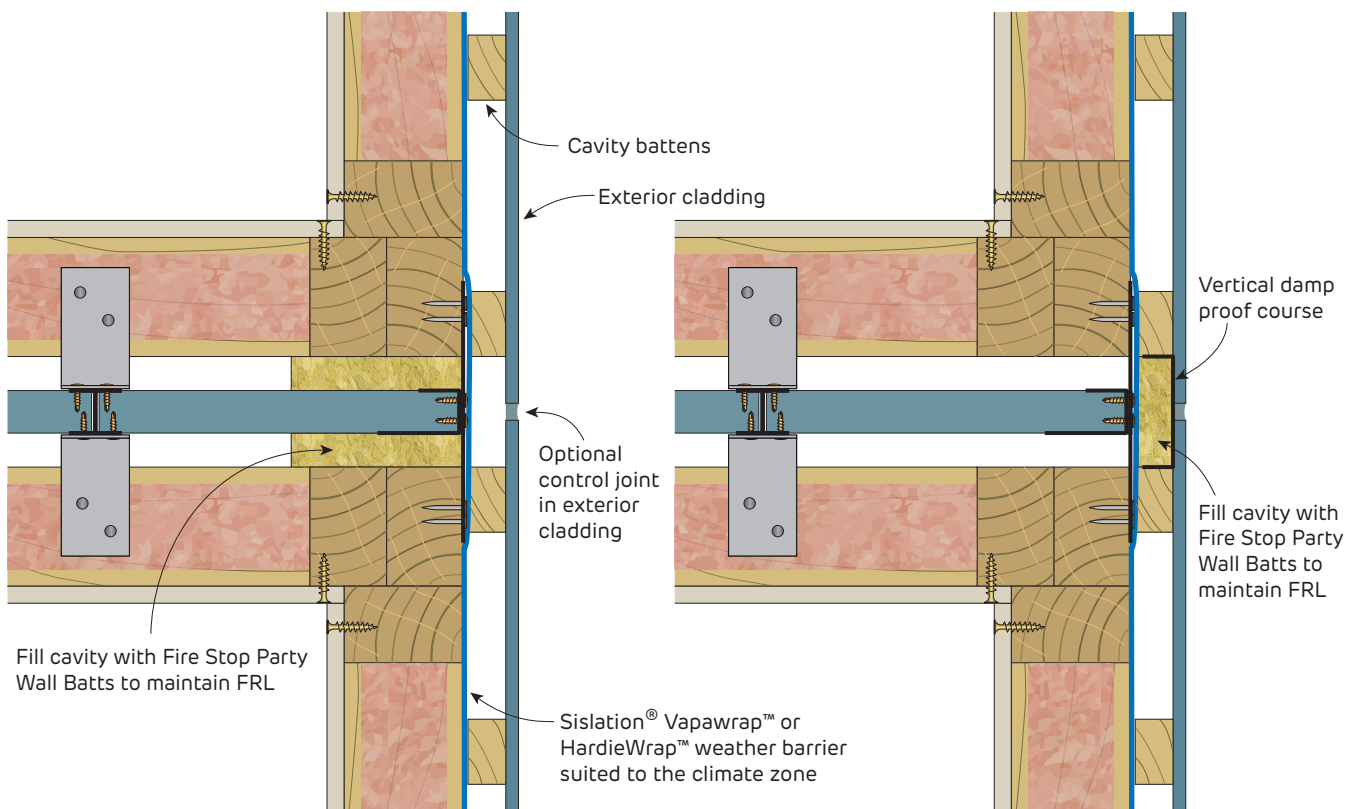

FIGURE 65 Interhome Wall to External Clad Wall with Cavity Battens

FRL 60/60/60

Plan

FIGURE 66 Interhome Wall to External Clad Wall with Cavity Battens

FRL 60/60/60

Plan

Fire Rated
Interhome Wall To External Wall

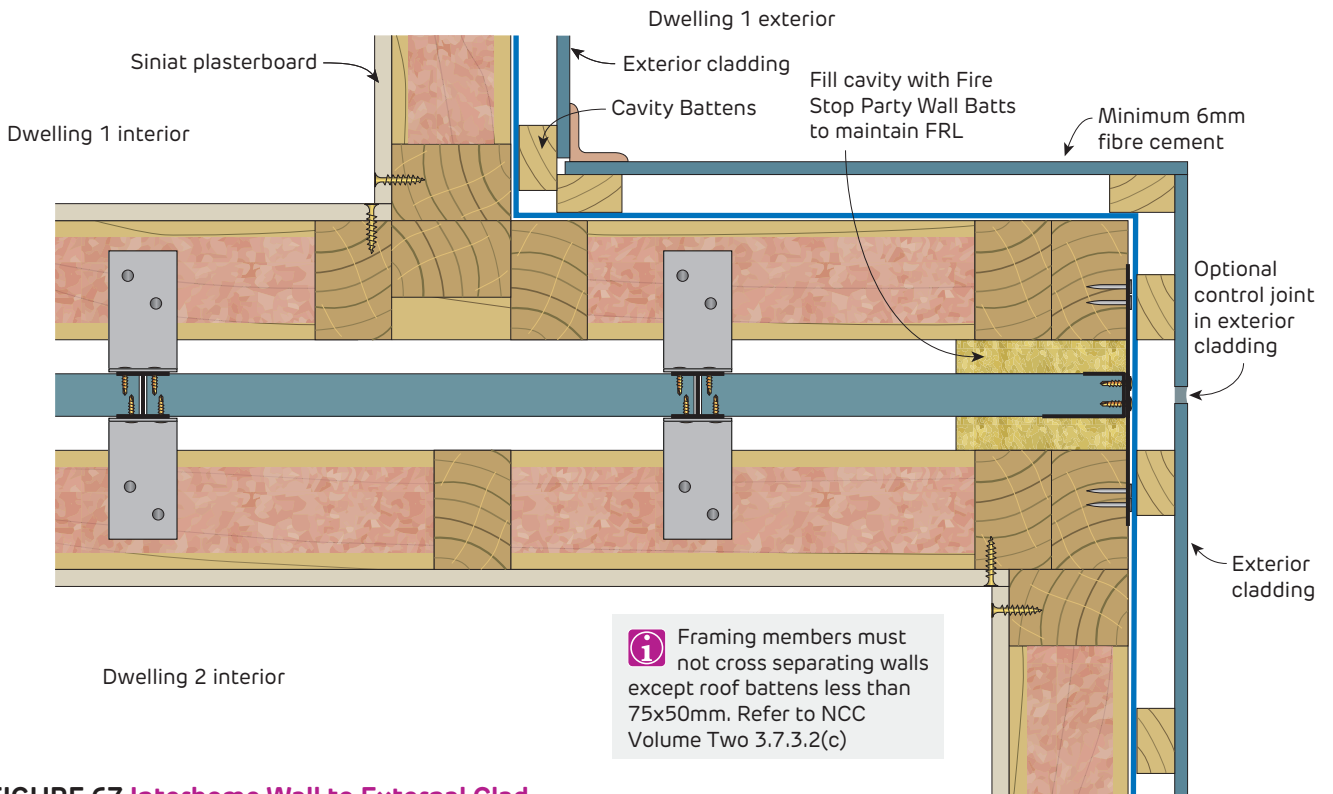

FIGURE 67 Interhome Wall to External Clad Wall with Cavity battens with Return
FRL 60/60/60
Plan

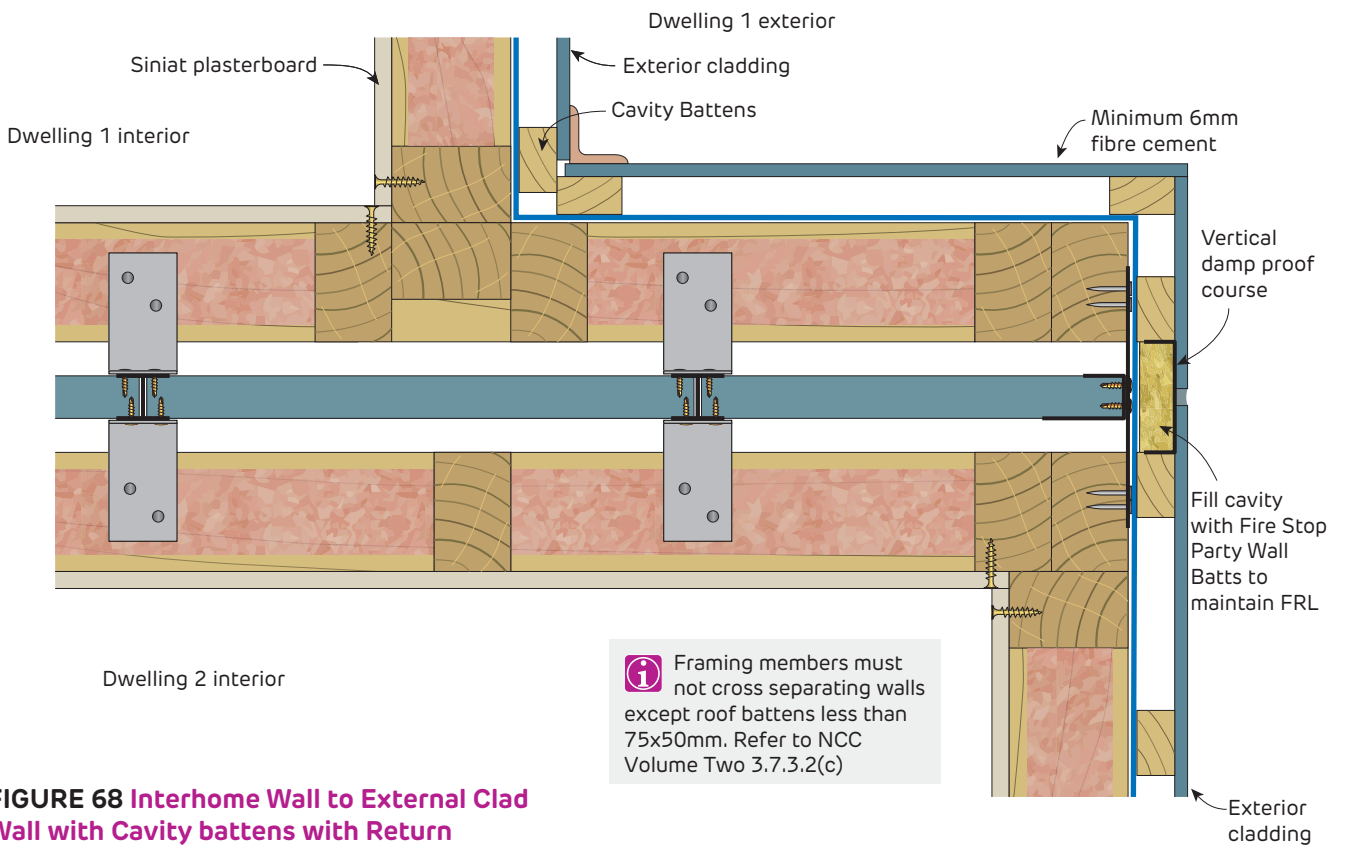

FIGURE 68 Interhome Wall to External Clad Wall with Cavity battens with Return
FRL 60/60/60
Plan



Fire Rated
Interhome Wall To External Wall

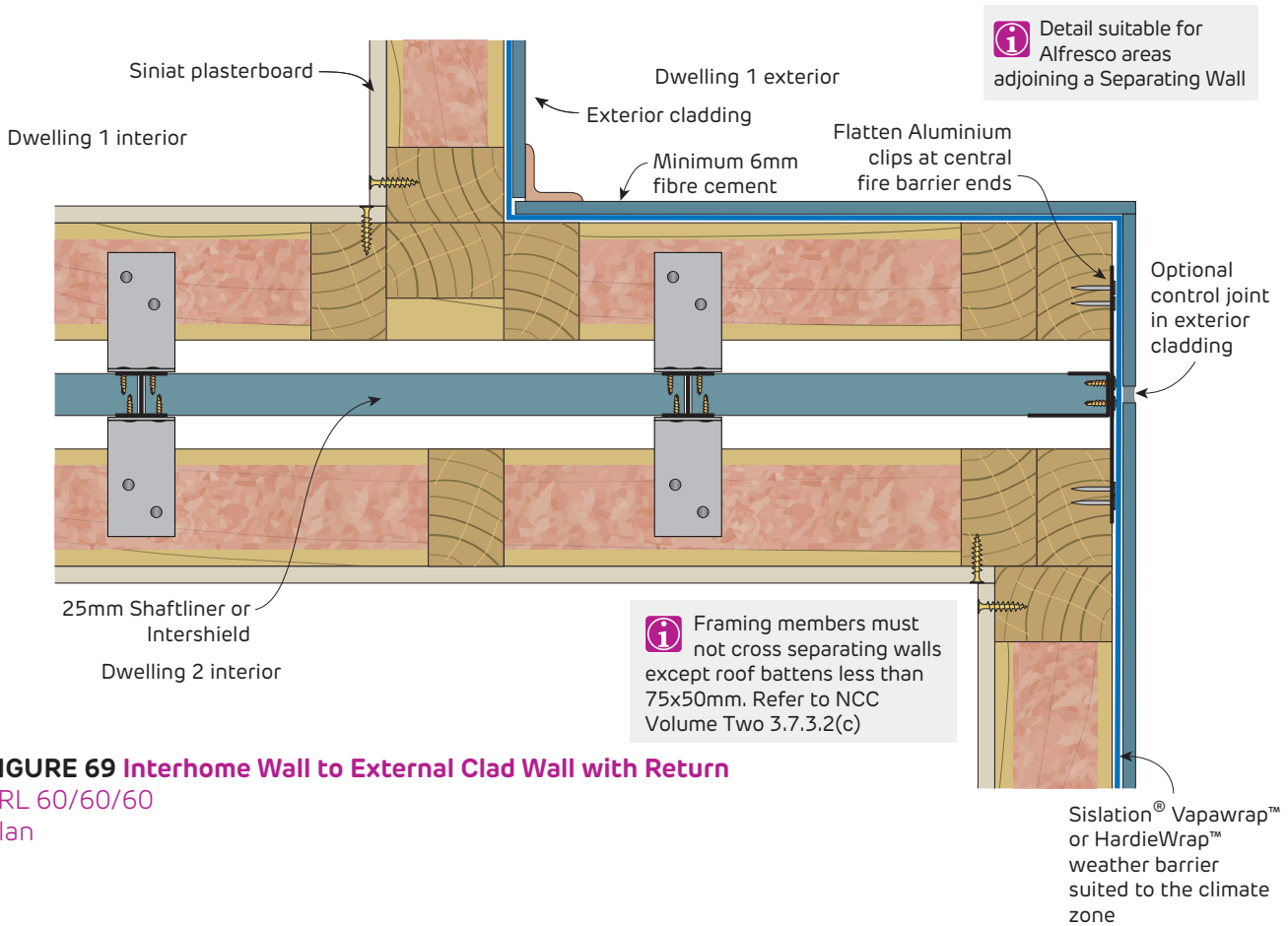

FIGURE 69 Interhome Wall to External Clad Wall with Return
FRL 60/60/60
Plan

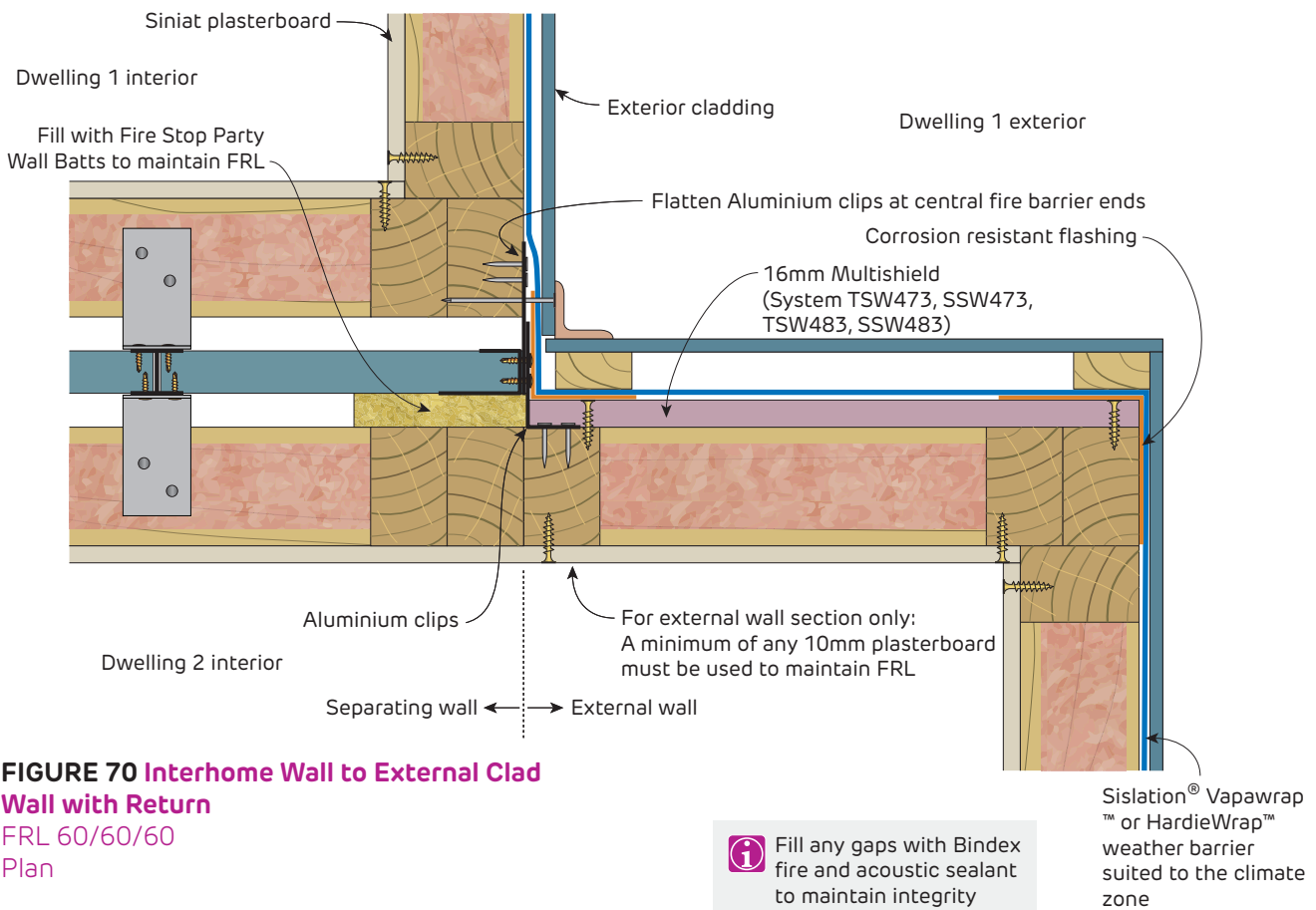

FIGURE 70 Interhome Wall to External Clad Wall with Return
FRL 60/60/60
Plan

Fire Rated
Interhome Wall To External Wall

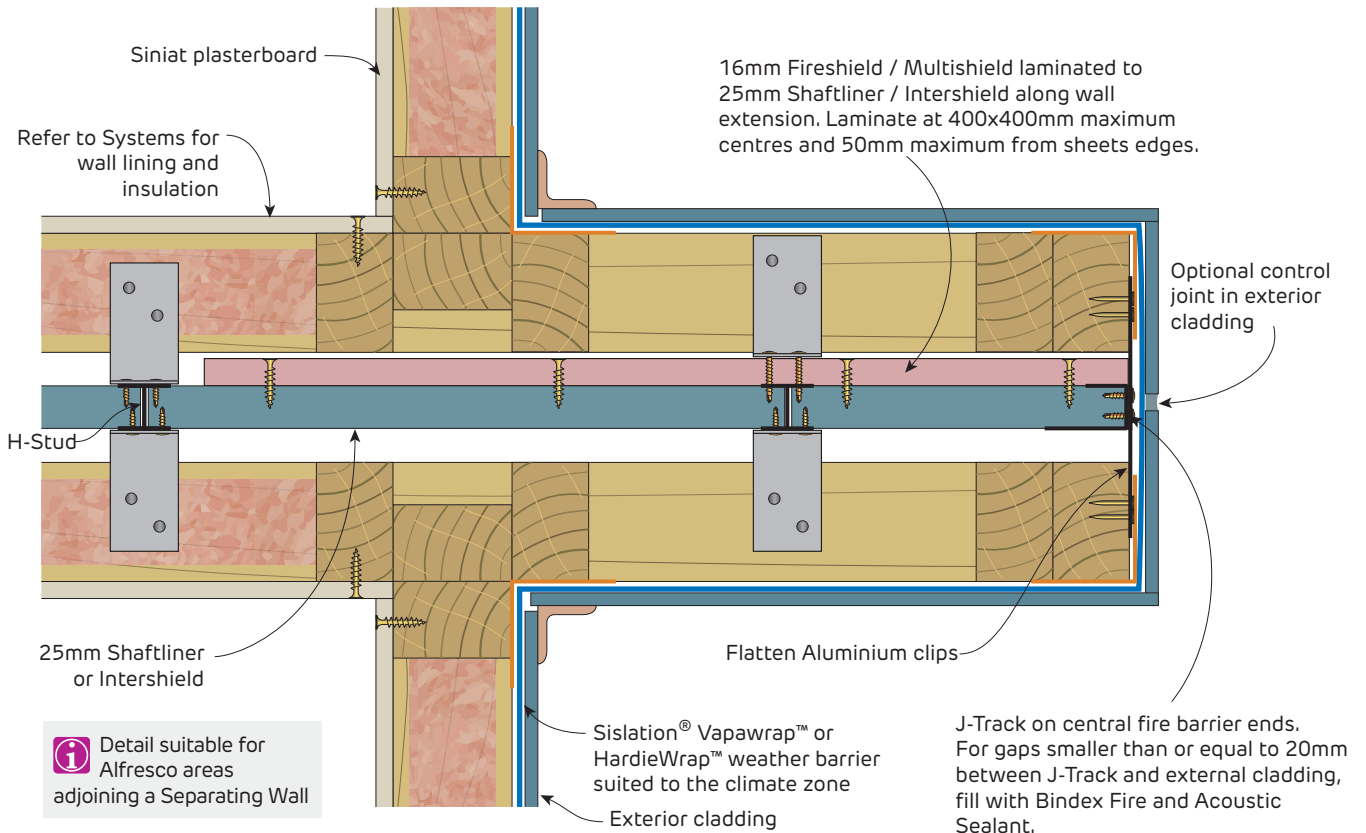

FIGURE 71 Interhome Wall with External Wall Extension
FRL 60/60/60
Plan



Fire Rated Interhome Wall To External Wall

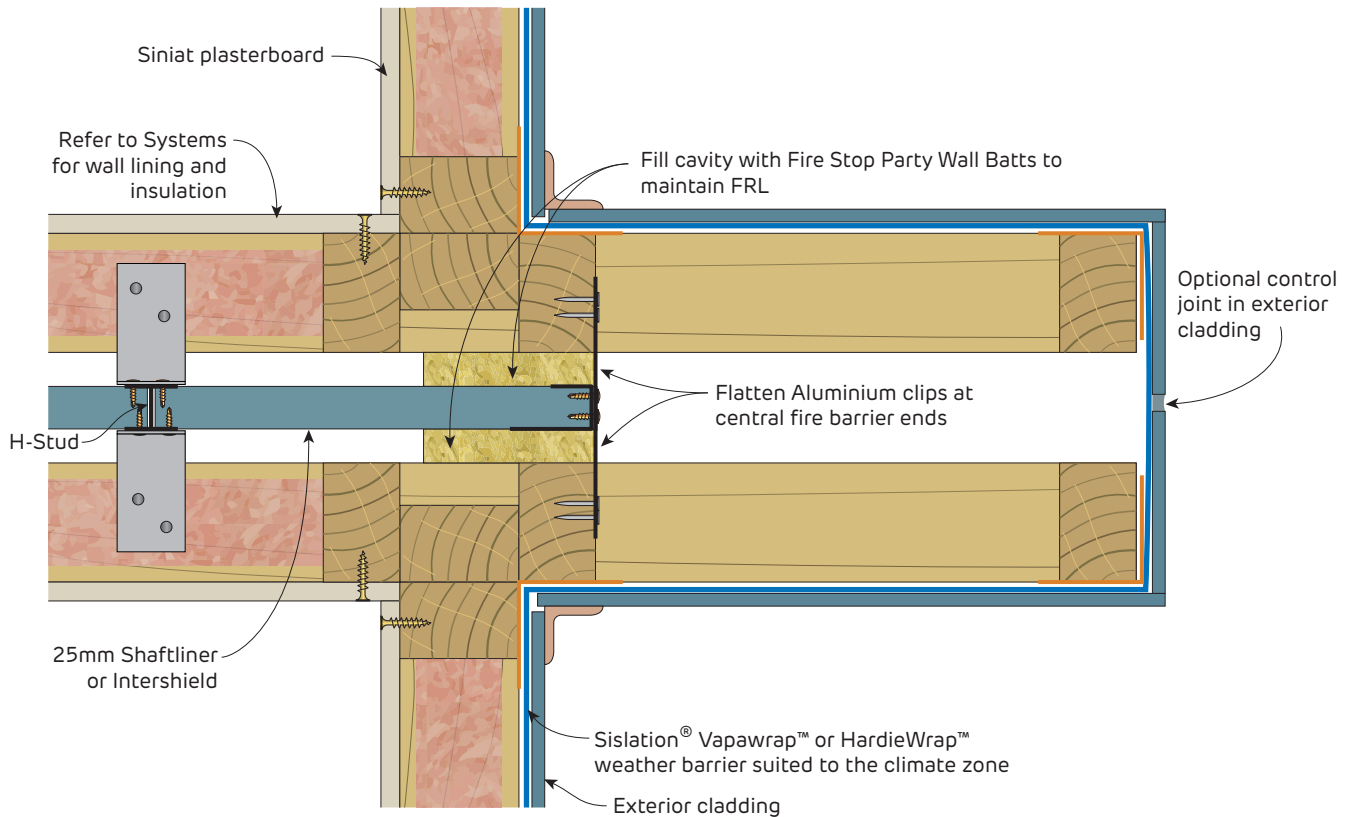

FIGURE 72 Interhome Wall with External Wall Extension

Timber Frame - FRL 60/60/60

Plan

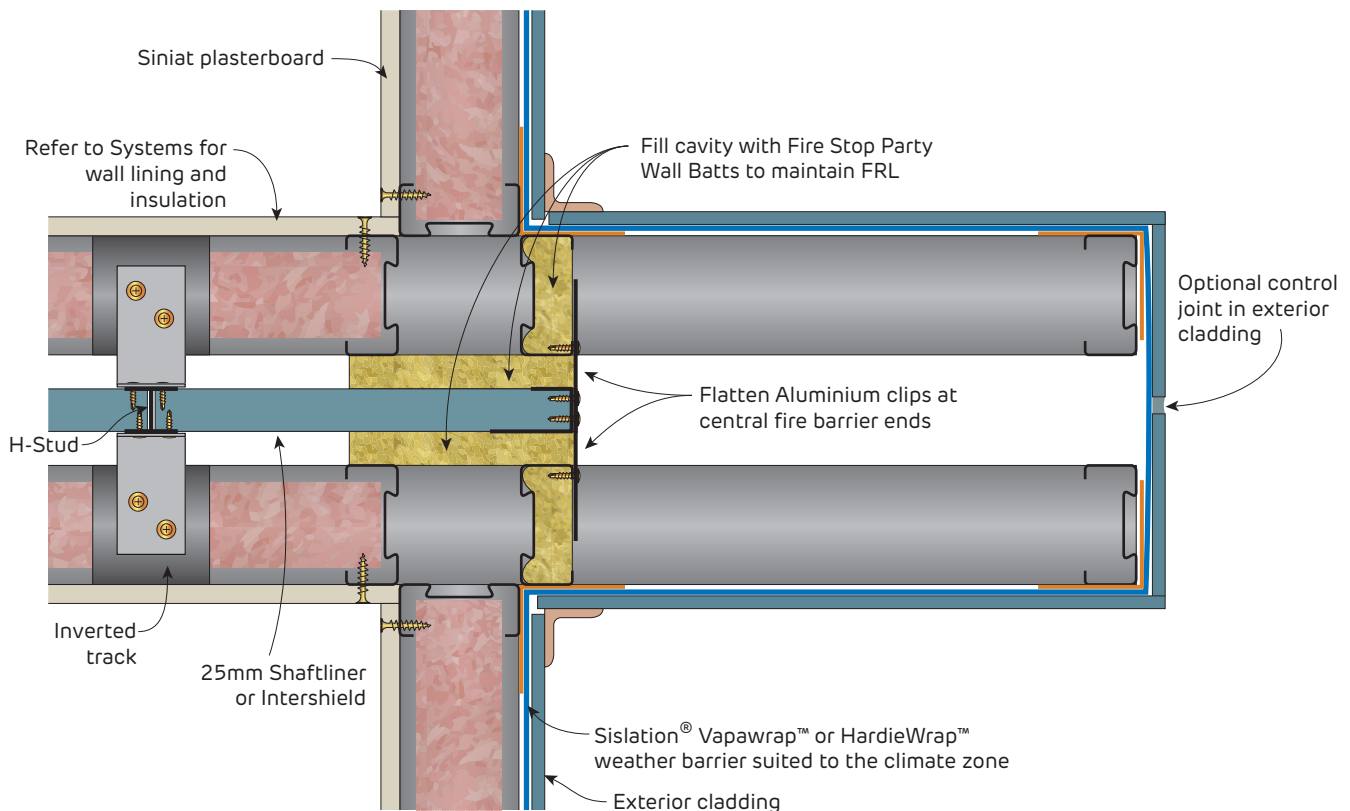

FIGURE 73 Interhome Wall with External Wall Extension

Steel Frame - FRL 60/60/60

Plan

Fire Rated
Interhome Overhanging Nib Wall

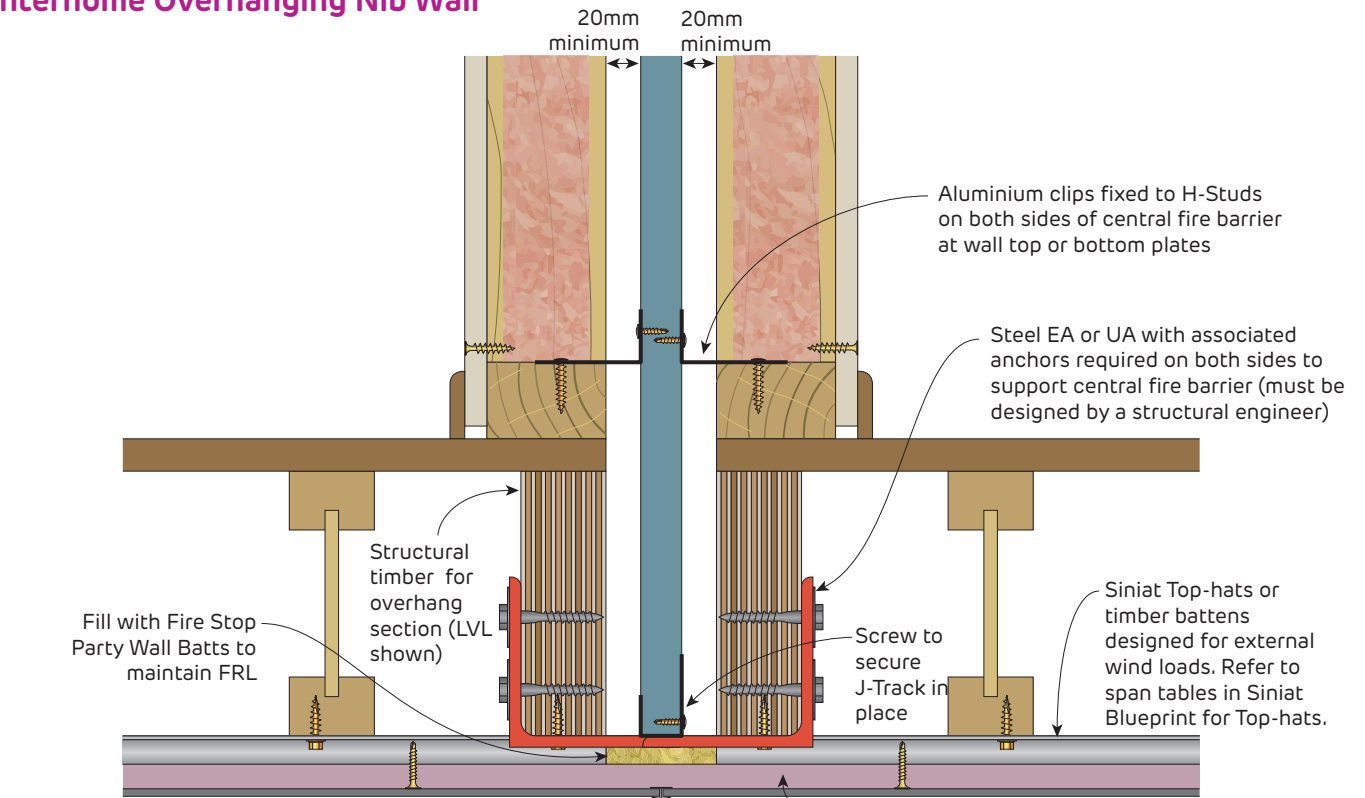

FIGURE 74 Interhome Overhanging Nib Wall
FRL 60/60/60
Section

13mm Fireshield or Multishield installed a minimum of 1.8m from the separating wall on both sides (in accordance with NCC Volume Two - Section 3.7.3.5. Install the 13mm fire rated plasterboard at maximum 600mm framing centres with screws at 200mm maximum centres. Jointing: a) With additional eave lining: Jointing is not required. b) Without additional eave lining: Joint with paper tape and 2 coats of MastaBase/MastaLongset and follow Siniat External Ceiling requirements.

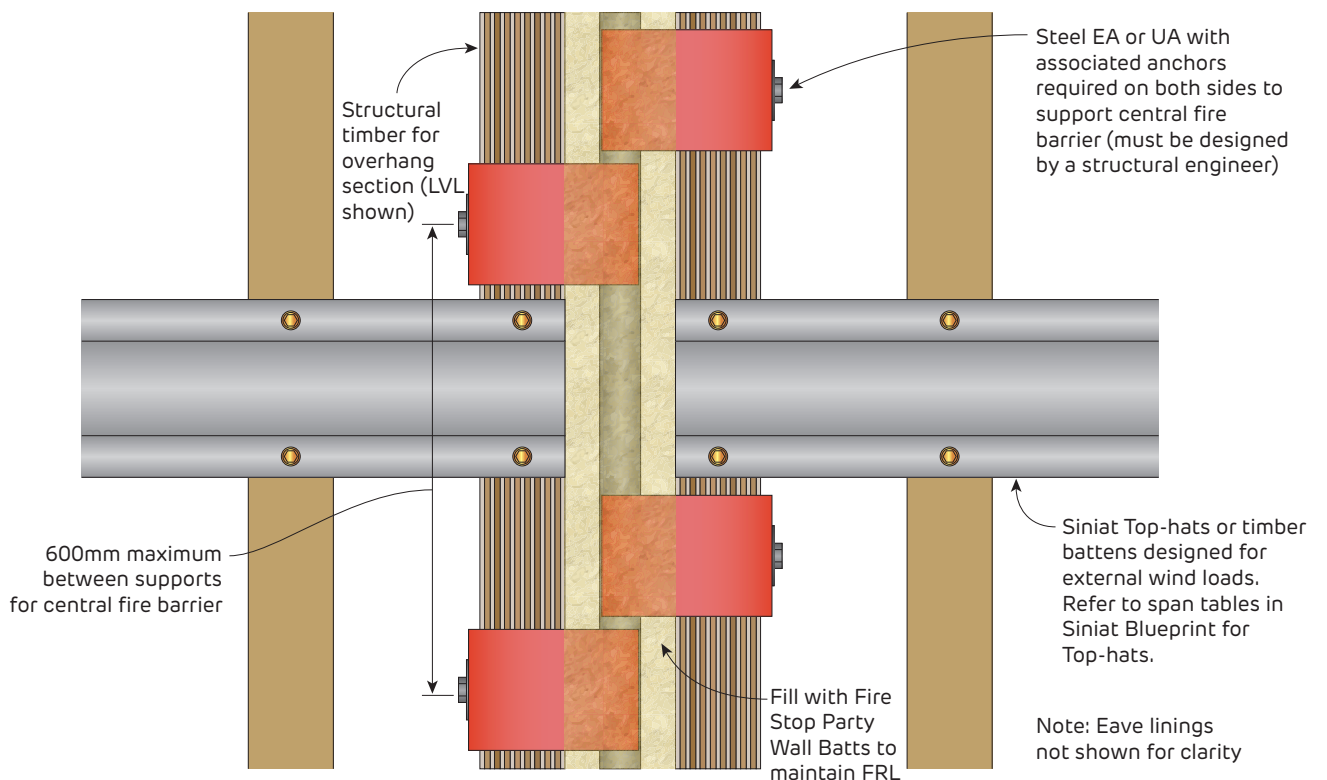

FIGURE 75 Interhome Overhanging Nib Wall
FRL 60/60/60
Ceiling Detail Viewed from Below

Fire Rated
Interhome Overhanging Nib Wall

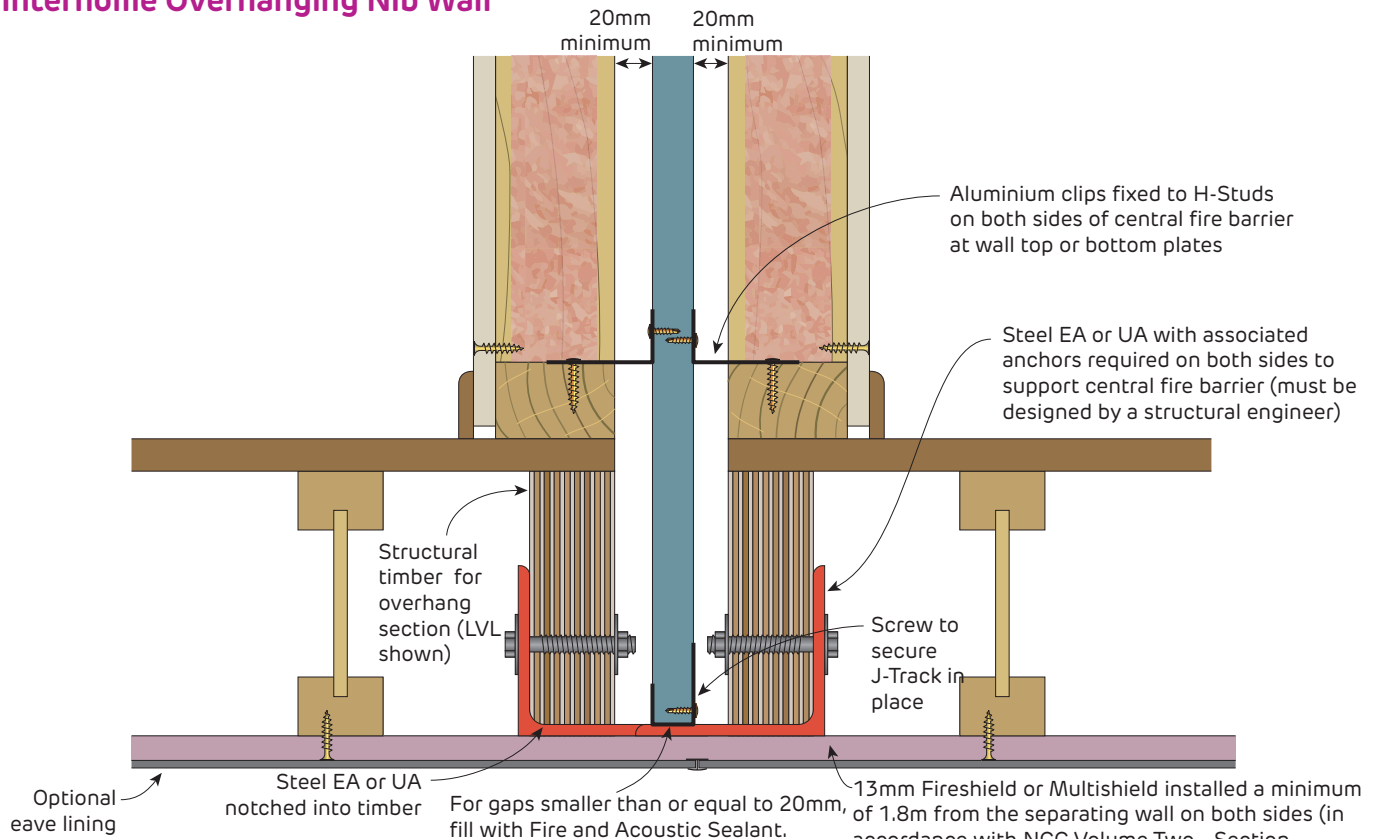

FIGURE 76 Interhome Overhanging Nib Wall
FRL 60/60/60
Section

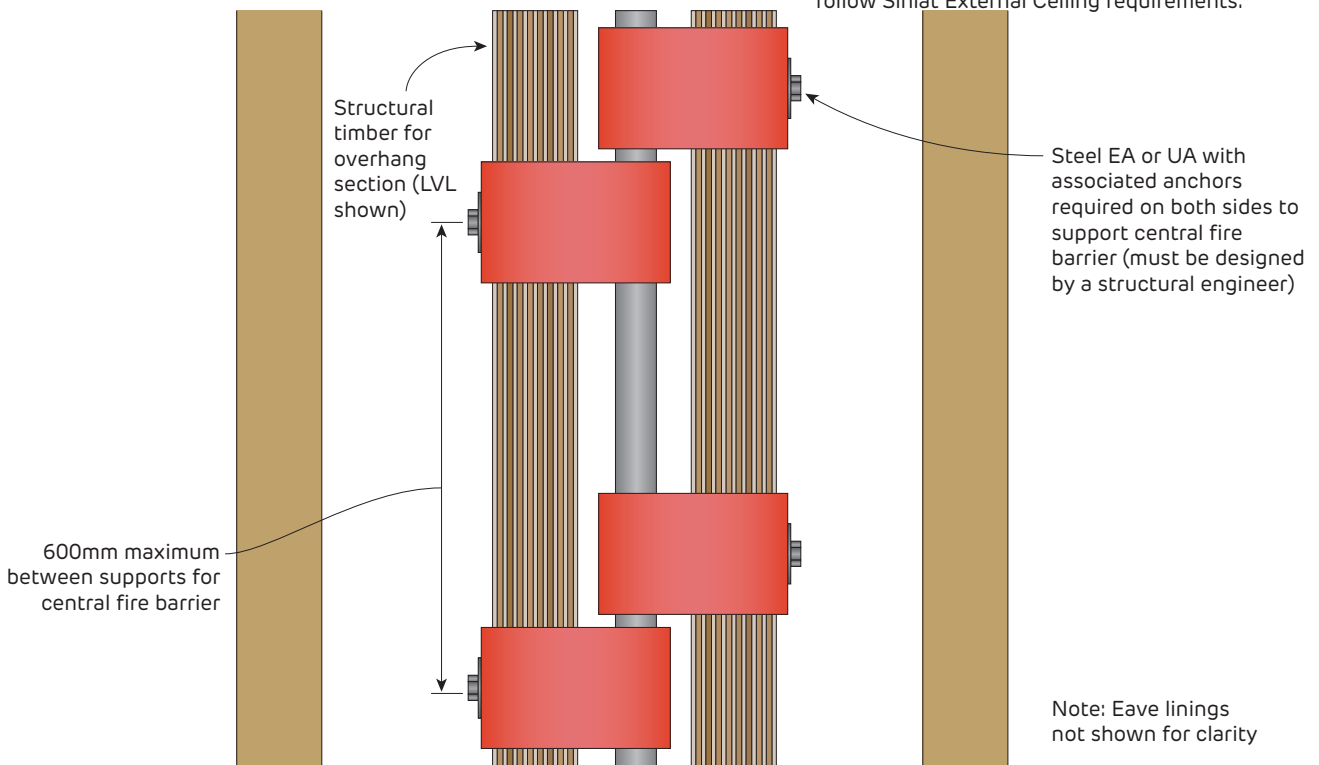

FIGURE 77 Interhome Overhanging Nib Wall
FRL 60/60/60
Ceiling Detail Viewed from Below

Fire Rated
Interhome Overhanging Nib Wall

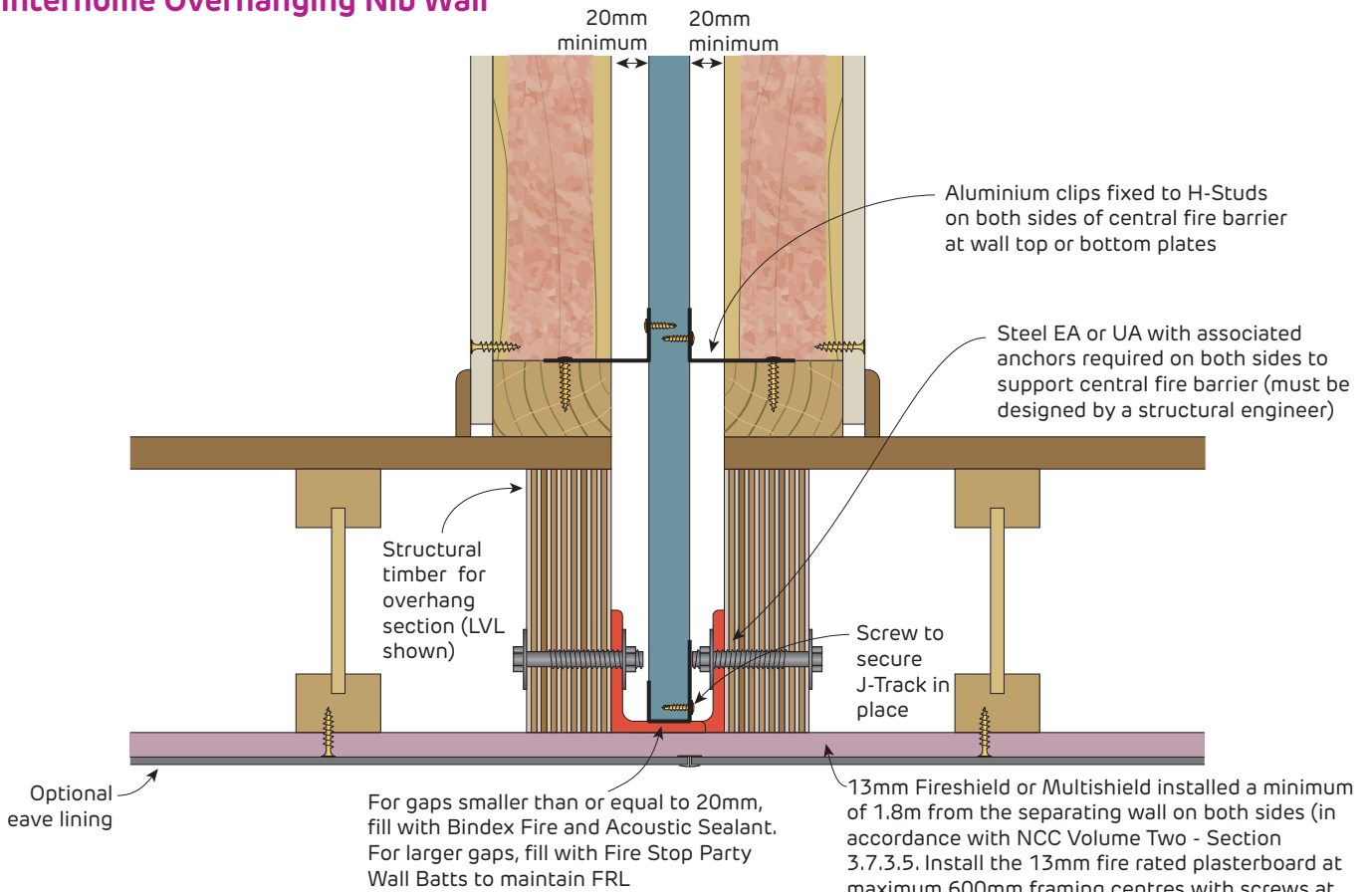

FIGURE 78 Interhome Overhanging Nib Wall
FRL 60/60/60
Section

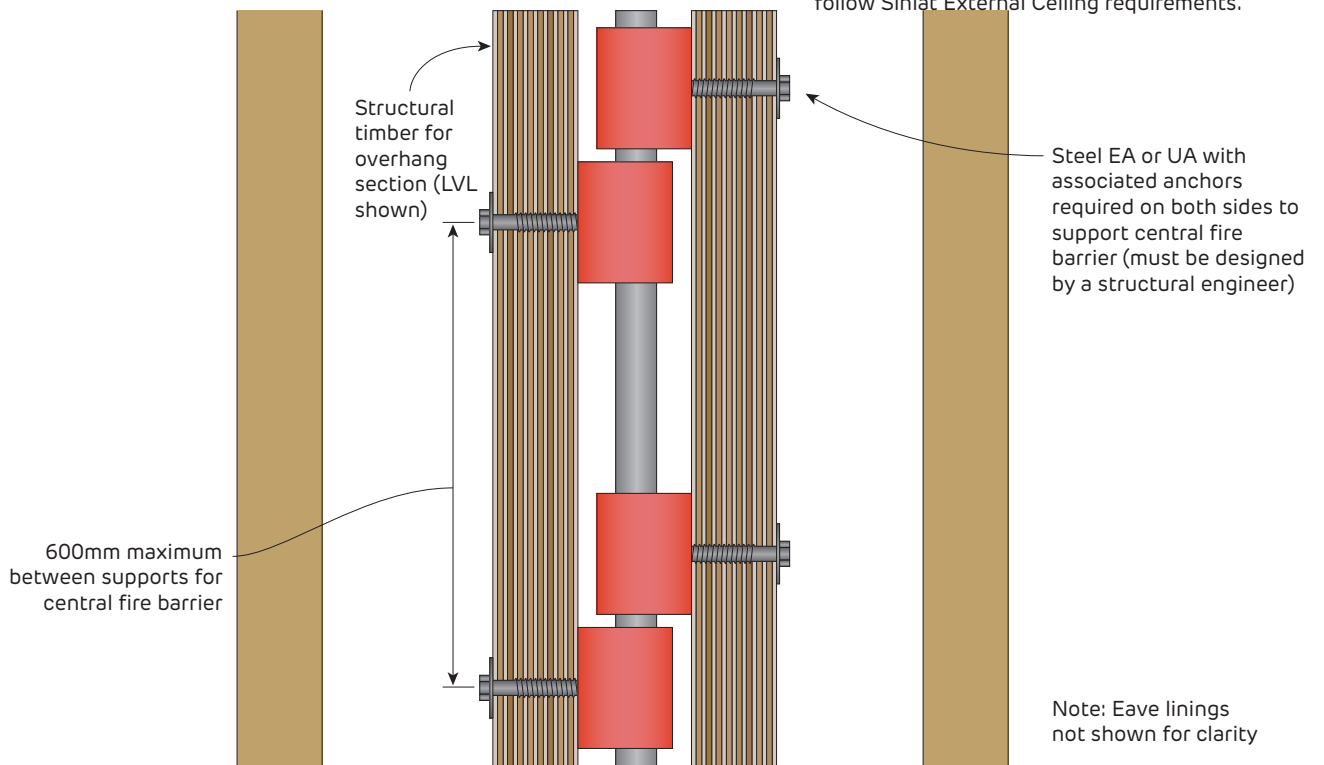

FIGURE 79 Interhome Overhanging Nib Wall
FRL 60/60/60
Ceiling Detail Viewed from Below



Fire Rated

Interhome Overhanging Nib Wall

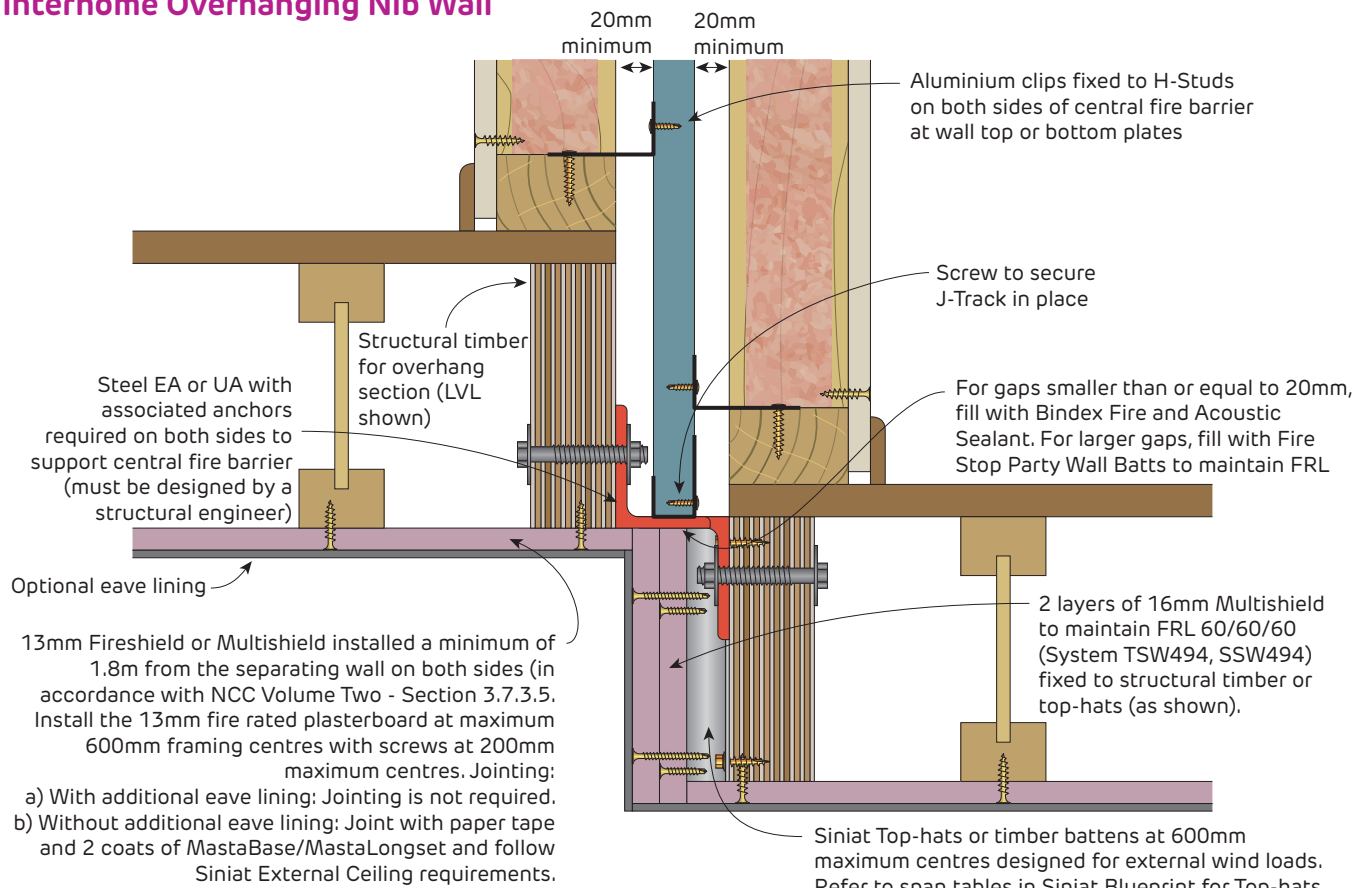

FIGURE 80 Interhome Overhanging Nib Wall

FRL 60/60/60

Section



Fill any gaps with Bindex fire and acoustic sealant to maintain integrity

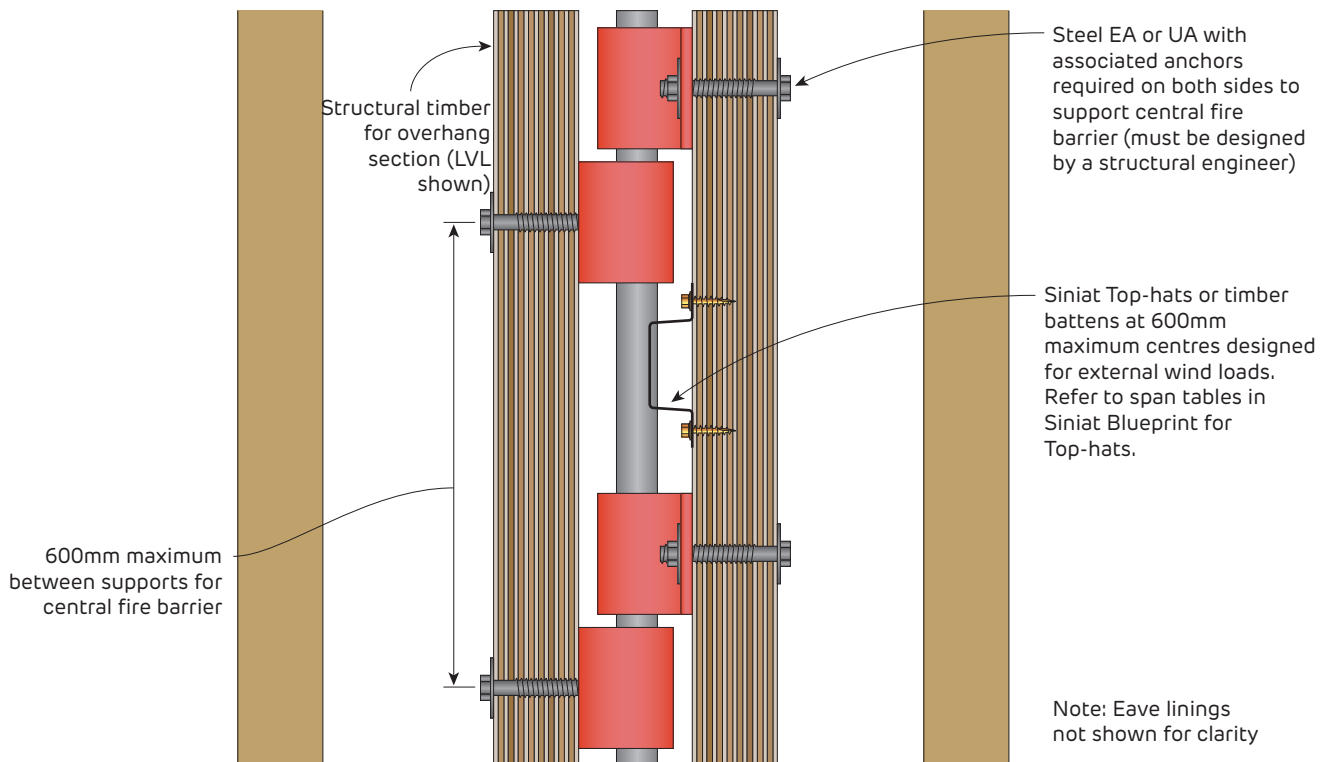

FIGURE 81 Interhome Overhanging Nib Wall

FRL 60/60/60

Ceiling Detail Viewed from Below

Fire Rated
Interhome Overhanging Nib Wall

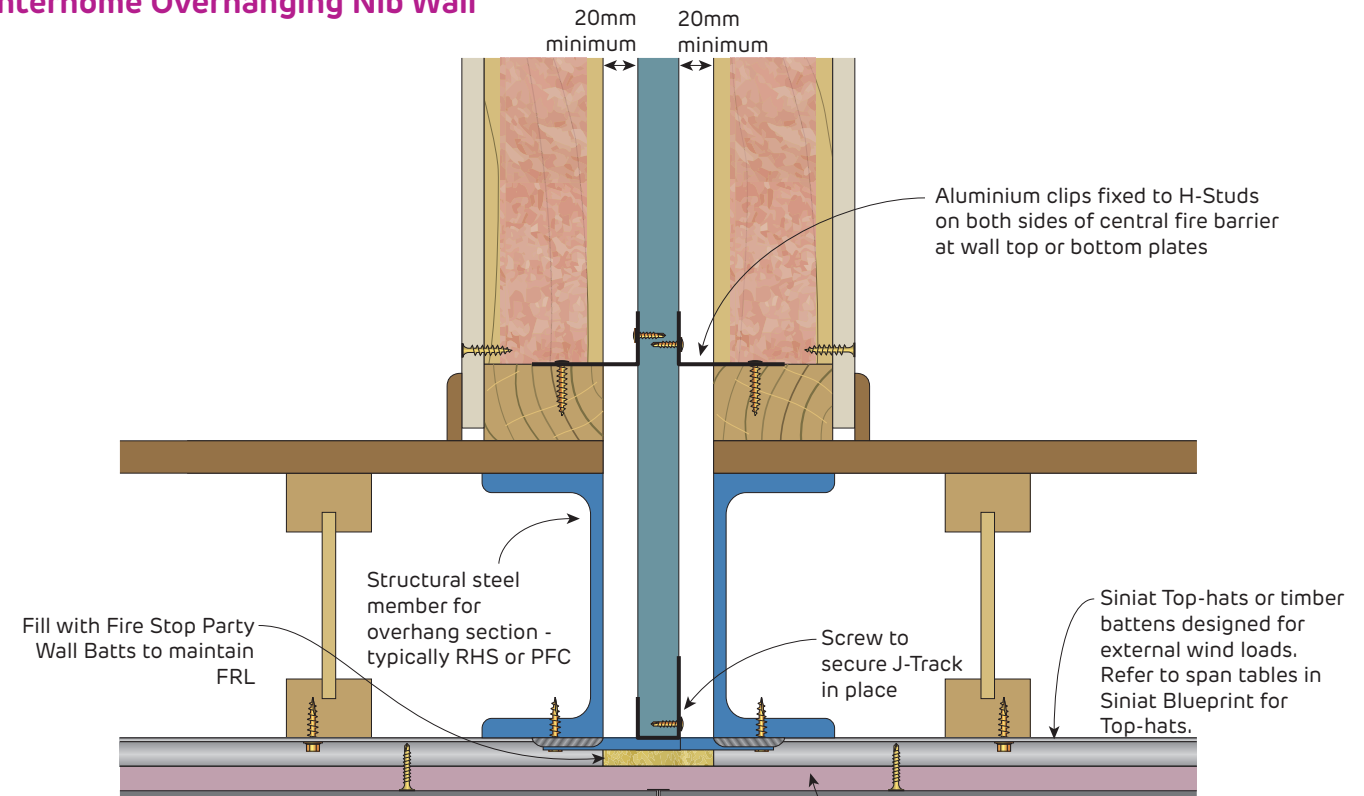

FIGURE 82 Interhome Overhanging Nib Wall
FRL 60/60/60
Section

13mm Fireshield or Multishield installed a minimum of 1.8m from the separating wall on both sides (in accordance with NCC Volume Two - Section 3.7.3.5). Install the 13mm fire rated plasterboard at maximum 600mm framing centres with screws at 200mm maximum centres. Jointing:
a) With additional eave lining: Jointing is not required.
b) Without additional eave lining: Joint with paper tape and 2 coats of MastaBase/MastaLongset and follow Siniat External Ceiling requirements.

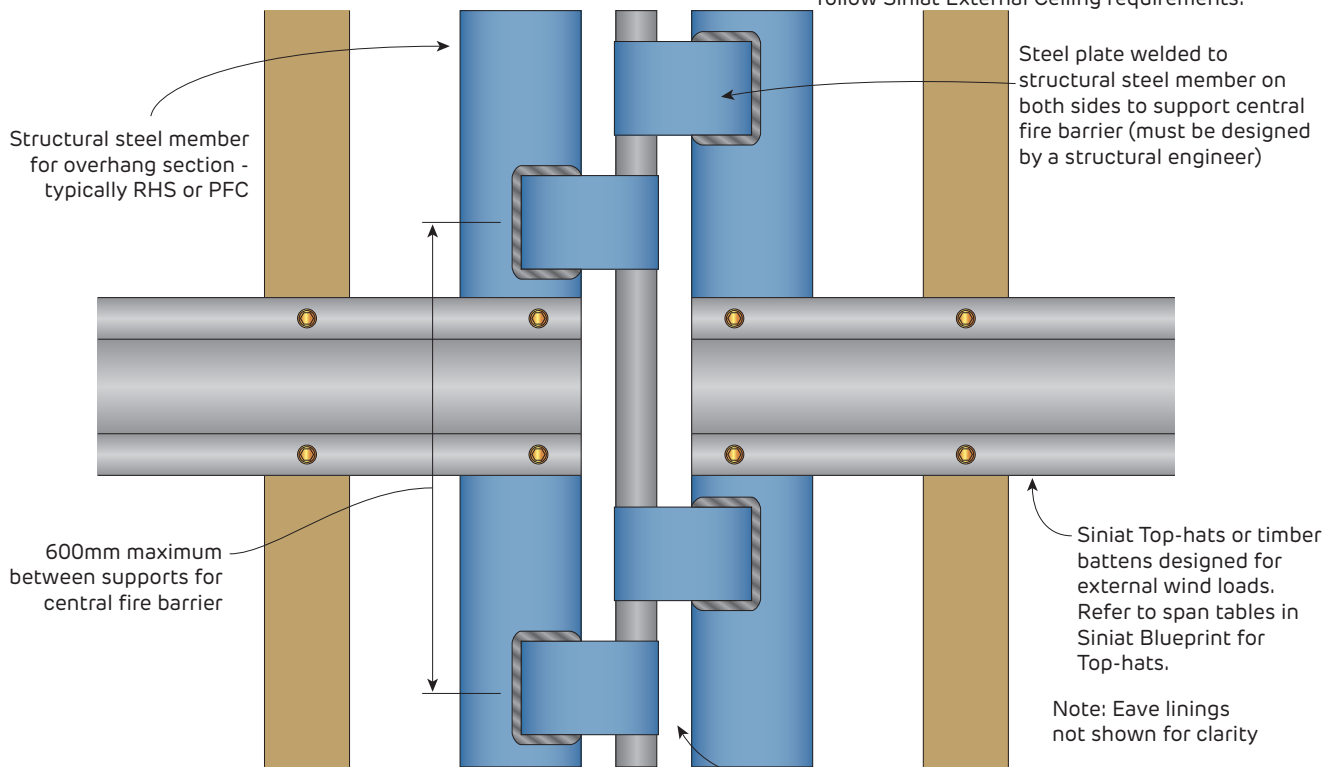

FIGURE 83 Interhome Overhanging Nib Wall
FRL 60/60/60
Ceiling Detail Viewed from Below

Fill with Fire Stop Party Wall Batts to maintain FRL



Fire Rated Penetration Details

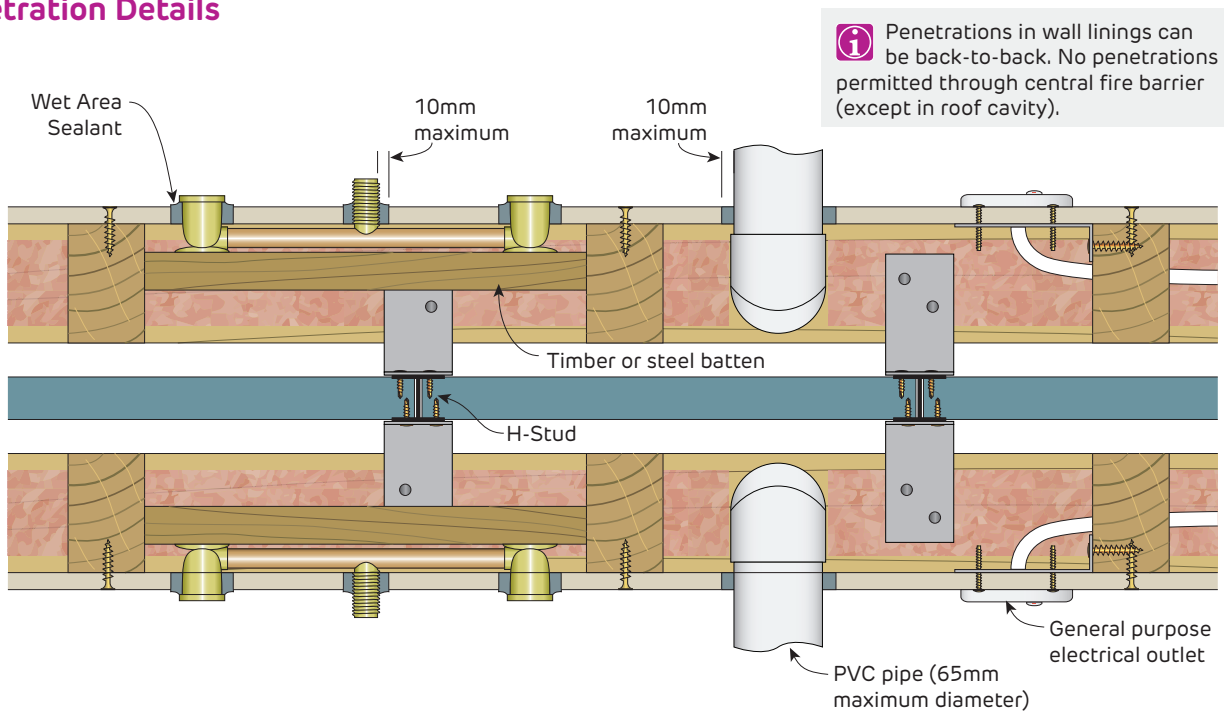

FIGURE 84 Interhome Wall with Plumbing and Electrical Penetrations in Wall Linings

FRL 60/60/60

Plan

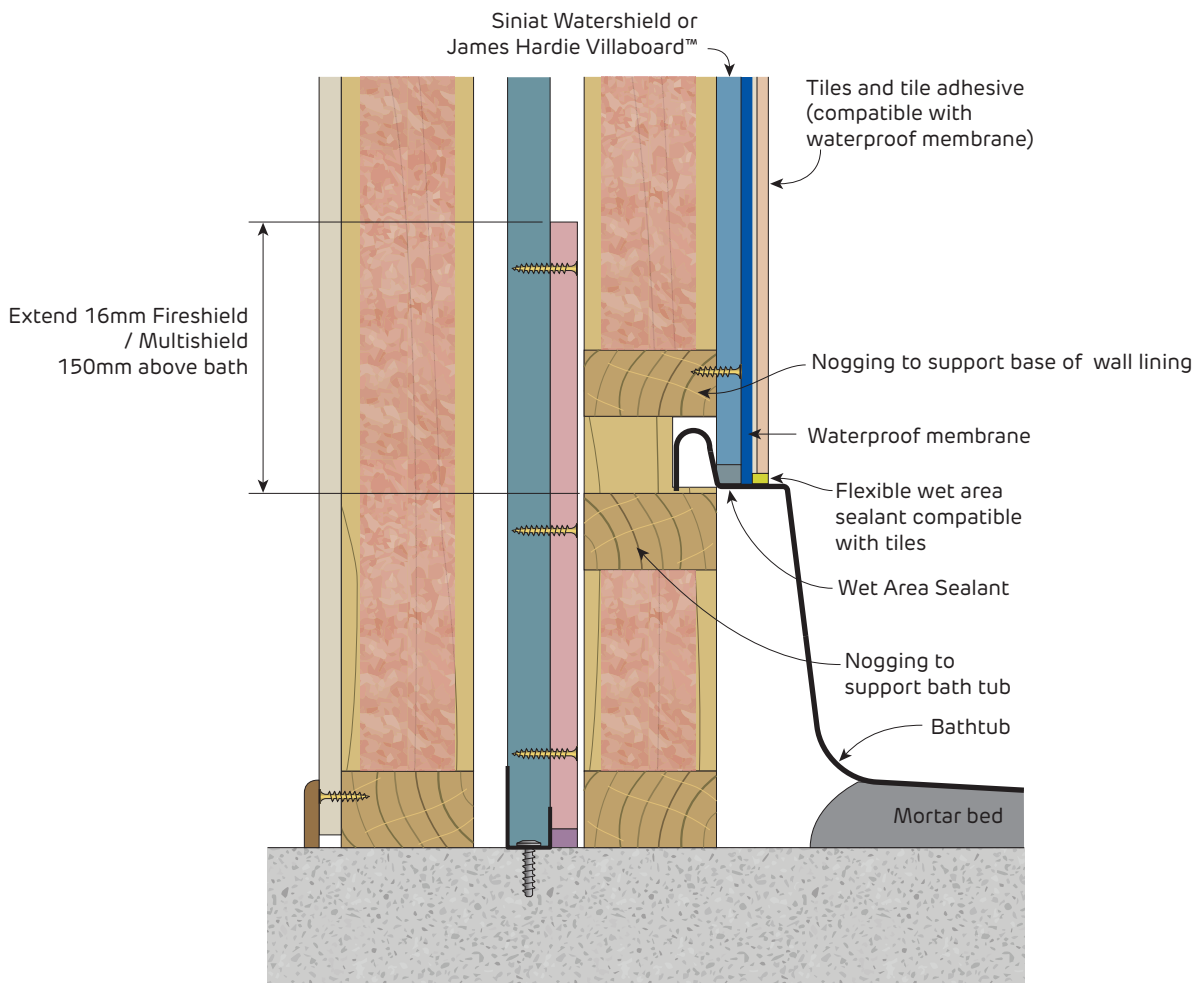

FIGURE 85 Interhome Wall with Integrated Bath Tub in Wet Areas

FRL 60/60/60

Section

**Fire Rated
Penetration Details**

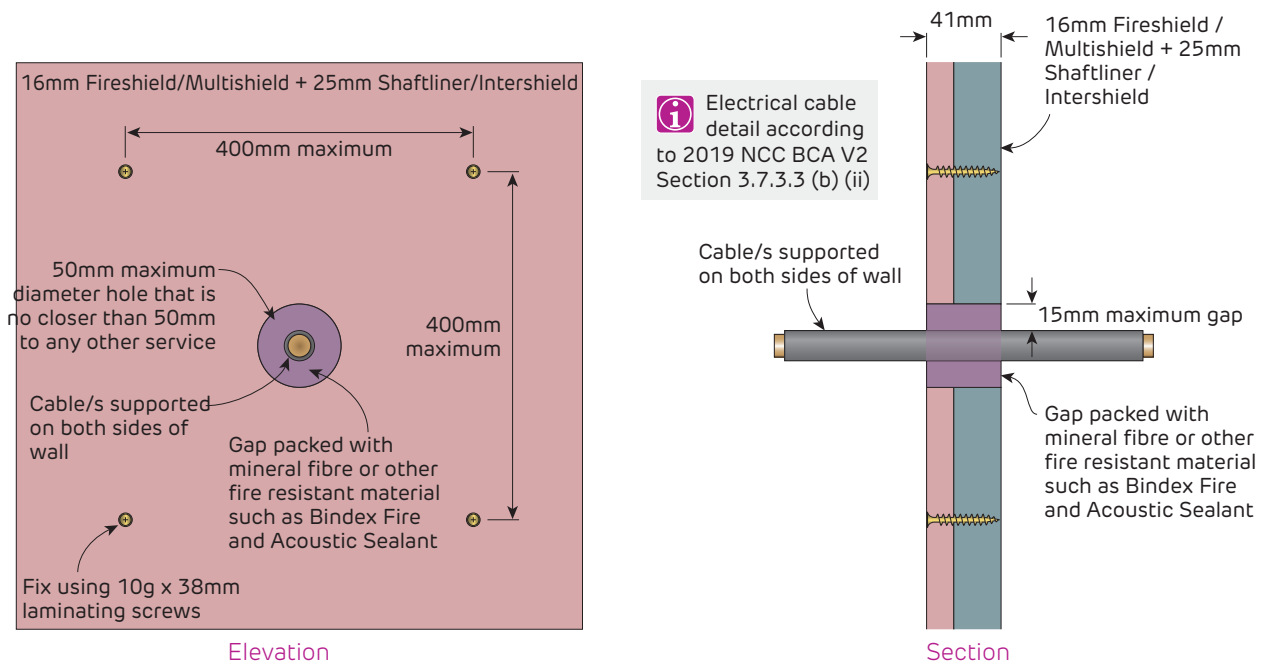

FIGURE 86 Single Cable Penetration Through Central Fire Barrier in Roof Cavity

Telecommunication and Power cables

Maintains FRL 60/60/60 of Interhome Wall System



Fire Rated

Patching Of Central Fire Barrier - 50x50mm maximum opening

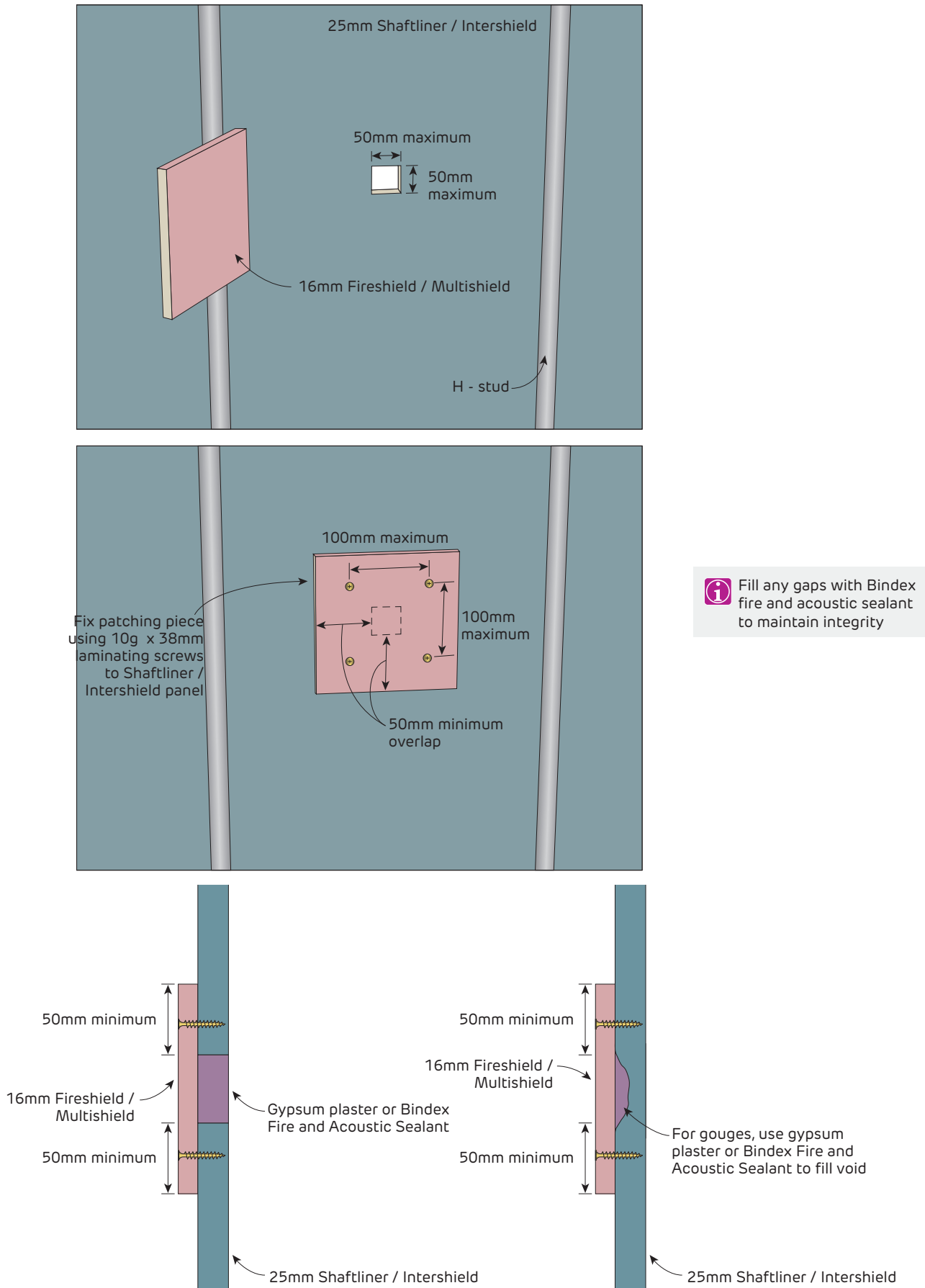
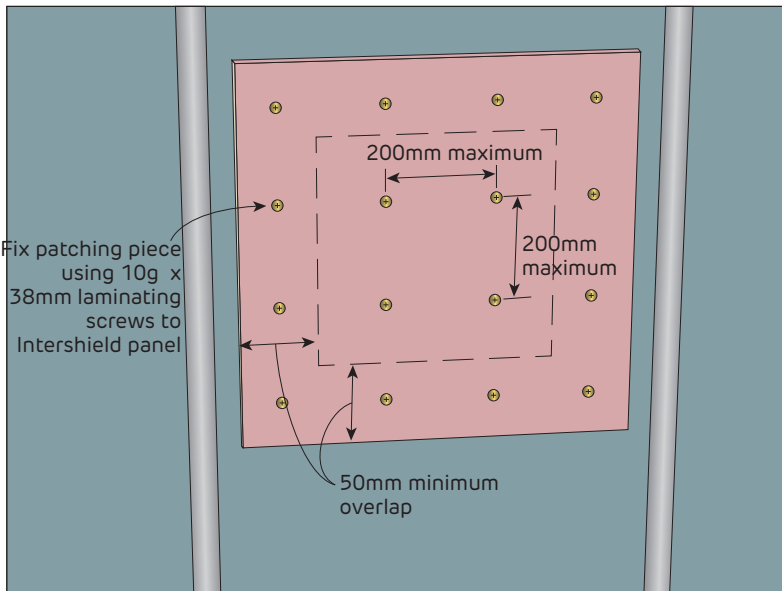
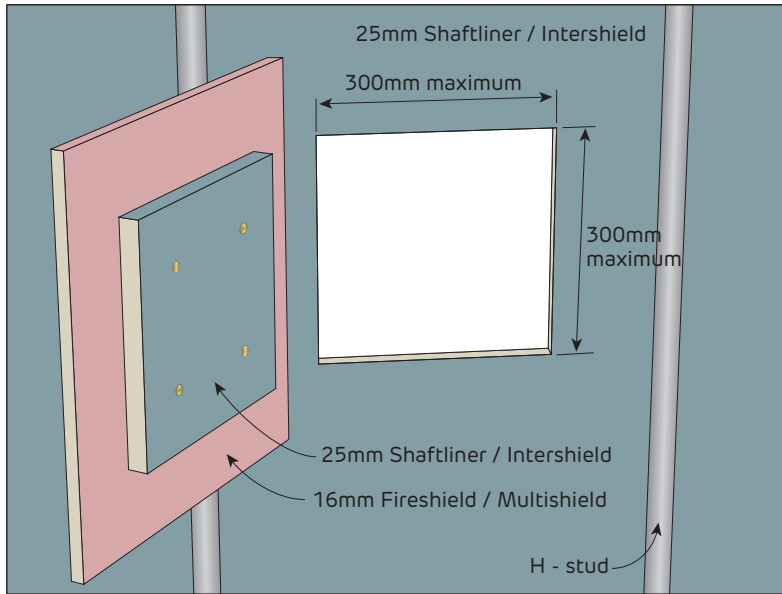

FIGURE 87 Fire Rated Patch for Shaftliner / Intershield panel
Section - FRL 60/60/60

Fire Rated

Patching Of Central Fire Barrier - 300x300mm maximum opening



i Fill any gaps with Bindex fire and acoustic sealant to maintain integrity

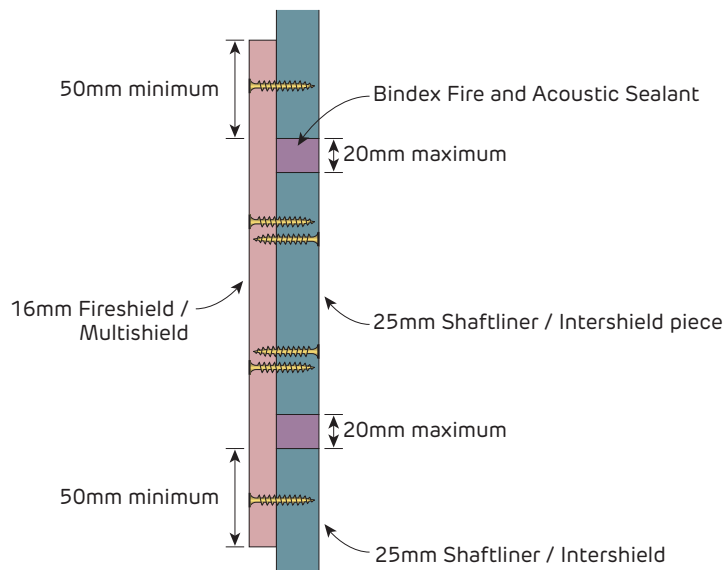

FIGURE 88 Fire Rated Patch for Shaftliner / Intershiield panel
Section - FRL 60/60/60



Fire Rated

Patching Of Central Fire Barrier - Crack in Shaftliner / Intershield

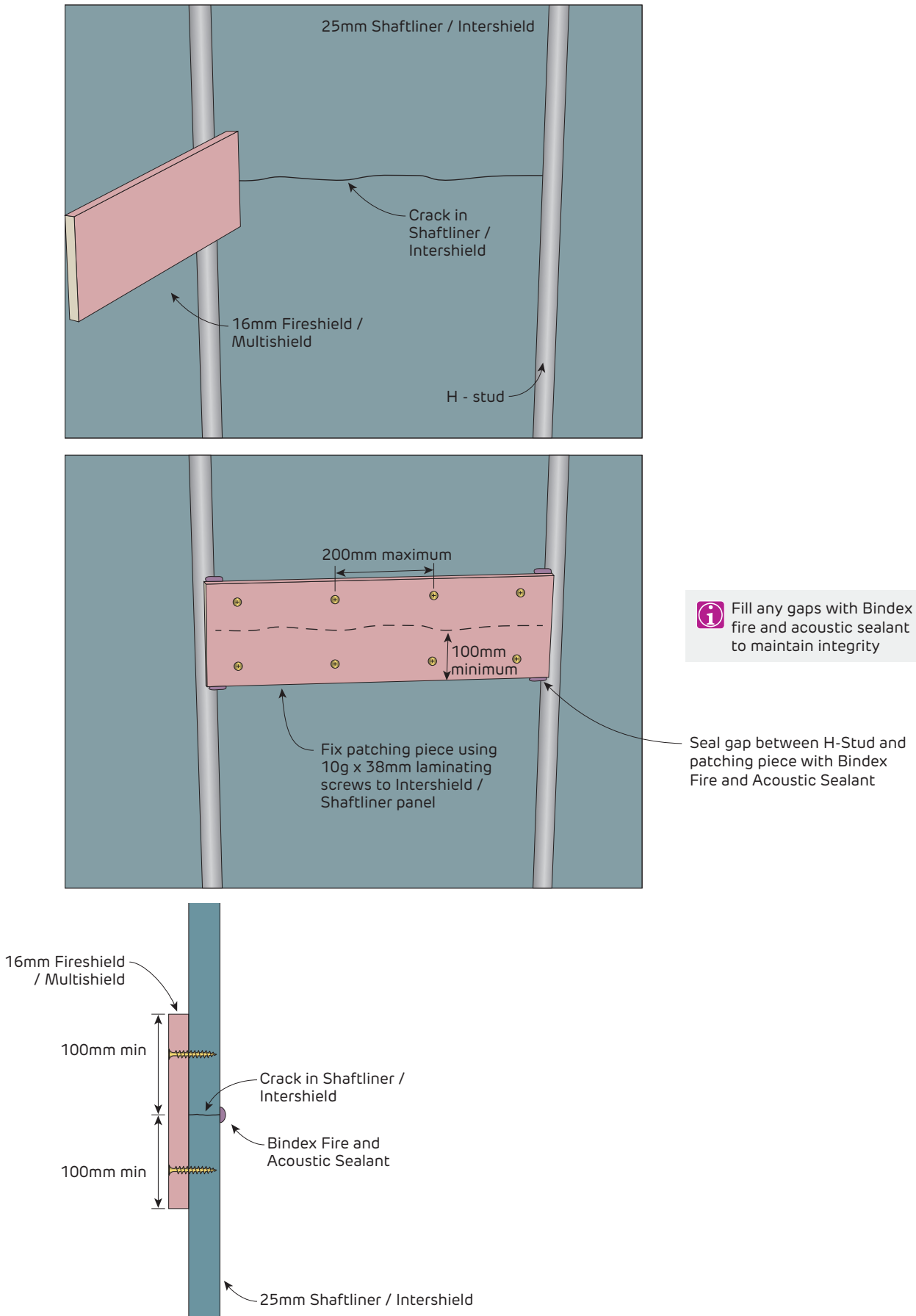

FIGURE 89 Fire Rated Patch for Shaftliner / Intershield panel
Section - FRL 60/60/60



Check List

- There is a minimum 20mm gap between both frames and the **shaftliner** / **intershield**.
- The stud frames or services attached to these frames do not touch the Central Fire Barrier (**shaftliner** / **intershield**, H-Studs, J-Track and 16mm **fireshield** / **multishield**).
- The J-Track is fixed, using suitable fasteners, to the concrete slab every 600mm and 150mm from each end or alternatively, Aluminium clips are used at the bottom plate.
- Any gaps between the J-Track and concrete slab are filled with fire sealant.
- shaftliner** / **intershield** sheets are not damaged. Paper tears are ok.
- Horizontal framing between **shaftliner** / **intershield** sheets consists of two J-Tracks screw fixed back to back.
- J-Track caps the ends and the top of the **shaftliner** / **intershield** wall as shown in the construction details
- Aluminium clips are within 700mm of where H-Studs meet (back to back J-Tracks) and vertically separated by a maximum of the H-Stud length (3000mm or 3600mm).
- Aluminium clips are on both sides of each H-Stud near all ceilings (top or bottom plate) and the top chord of the roof truss.
- 16mm **fireshield** / **multishield** is laminated at 400mm centres to the **shaftliner** / **intershield** in the roof space and at the floor levels.
- Mineral wool is installed over the top of the **interhome** wall and mineral wool or fire sealant installed in the gap between the **interhome** wall and the brick or external cladding.
- No penetrations in the **shaftliner** / **intershield** except in the roof space and beneath the floor. These penetrations must be installed to a fire rated detail.
- Central Fire Barrier is protected from adverse weather.









Etex Australia Pty Ltd
ABN 61 003 621 010

31 Military Road
Matraville NSW 2036

siniat.com.au



warranty

Siniat's products are guaranteed
by a 10 year warranty.
For details visit siniat.com.au

customer service and
technical advice

AU 1300 724 505