



# Plasterboard Installation Guide

Low-rise Residential Dwellings

## Disclaimer

Products manufactured and construction systems designed by Etex Australia Pty Ltd and branded Siniat, are produced in accordance with the Building Code of Australia and relevant Australian Standards. Information in this document is to be used as a guide only and is subject to project approval as many aspects of construction are not comprehensively covered. It is the responsibility of the project to determine if our products, construction systems and installation details are suitable for the intended application and they meet the relevant building codes and project requirements. It is also the project's responsibility to ensure third party products have the appropriate certification for use with Siniat products and construction systems. Etex Australia Pty Ltd will not be held responsible for any claims resulting from the installation of Siniat products or other associated products not in accordance with the requirements of the manufacturer's technical literature or relevant Australian Standards, or for situations not covered by our certification reports.

Siniat technical information is regularly updated. To ensure this document is current with the latest information, visit [siniat.com.au](https://www.siniat.com.au) or contact Siniat Customer Service Centre on **1300 724 505**

## Warranty

Siniat products are guaranteed by a 10 Year Warranty.

Visit [siniat.com.au/warranty](https://www.siniat.com.au/warranty)

## Version 12

October 2024

# About Siniat

Siniat is one of the Etex Group's flagship commercial brands, and one of the leading global manufacturers of interior and exterior materials for drywall construction.

In Australia, Etex has Siniat manufacturing facilities located in Sydney, Melbourne, Bundaberg and Brisbane. Etex supplies Siniat branded plasterboard, compounds, cornice, steel profiles and associated products and systems to the Australian building industry through its national distribution network.

Siniat's comprehensive range of quality wall and ceiling lining products are developed with specific characteristics to enhance performance and provide fire, water, acoustic and decorative solutions to all construction projects.

The Siniat team is committed to providing excellent technical service and sales support to help with innovative solutions for your next project.

## Download Siniat Documents



# Contents

<b>INTRODUCTION</b>	<b>4</b>
<b>1 SINIAT PRODUCT RANGE</b>	<b>5</b>
<b>2 BUILDING WITH LIGHTWEIGHT CONSTRUCTION</b>	<b>11</b>
2.1 Materials	13
2.2 Care and Use	24
<b>3 INSTALLATION</b>	<b>27</b>
3.1 Ceilings	29
3.2 Walls	48
3.3 Wet Areas	56
<b>4 FINISHING PLASTERBOARD</b>	<b>67</b>
4.1 Levels of Finish	68
4.2 Back-Blocking	70
4.3 Jointing Plasterboard	73
4.4 Cornice Installation	77
4.5 Painting Plasterboard	78
4.6 Glancing Light	79



## Introduction

The Australian Standard for installing and finishing plasterboard is AS/NZS 2589-2017, *Gypsum linings – Application and finishing*.

This plasterboard installation guide includes information on non-fire rated installation of Siniat plasterboard in low-rise residential dwellings (Class 1 buildings according to the National Construction Code). It also presents Siniat's recommendations for best practice in plasterboard installation so the desired 'Level of Finish' is obtained for the application.

Unique to Siniat, **opal** is the premium solution for walls and ceilings providing superior noise reduction, impact resistance along with optimal aesthetics.

This guide covers the internal application of standard products such as **mastashield**, **spanshield**, **soundshield** and **opal** as well as **watershield** for wet areas and cornice fixing for decoration. Installation details are also included for typical applications including garage ceilings and external ceilings such as alfresco areas.

Siniat has a wide range of product solutions that can assist in tailoring each project to the needs of both the home owner and trades including specialist plasterboards, compounds and cornice.

The Siniat Knowhow complementary service offer provides specialist technical support advice with for the complete range of Siniat products and systems in your project.









# Siniat Product Range

## Recommended Application of Siniat Plasterboards

Plasterboard	Typical Use	Walls	Ceilings
<b>mastashield</b>	Standard wall and ceiling lining	✓	
<b>spanshield</b>	Standard ceiling lining		✓
<b>watershield</b>	Walls in wet areas in bathrooms, toilets and laundries	✓	
<b>soundshield</b>	Sound and impact resistant for walls and ceilings	✓	✓
<b>opal</b>	Sound and impact resistant with Premium Level 4 Finish for walls and ceilings*	✓	✓
<b>curveshield</b>	For curved walls and ceilings	✓	✓

\* For more information on Opal technology, refer to the latest Opal Data Sheet on the website.

## Plasterboard

Plasterboard	Thickness (mm)	Width (mm)	Length (mm)						Weight (kg/m <sup>2</sup> )	Properties		
			2400	2700	3000	3600	4200	4800			6000	
<b>mastashield</b>	10	1200	•	◆	•	•	◆	◆	• +	6.3	 Available under the Siniat Carbon Neutral program	
		1275							◆			
		1350	◆	◆	◆	•	◆	◆	•			
	13	1200	◆	•	•	•	◆	◆	◆			8.4
		1350			•	•		◆				
		1370			◆ +	◆ +						
		1400			◆ +	◆ +						
<b>spanshield</b>	10	1200	◆		◆	•	•	◆	•	6.8		
		1350				◆		◆	◆			
<b>watershield</b>	10	1200	◆	◆	•	◆	◆		◆	7.5		
		1350			◆	◆		•	◆			
	13	1200		◆	•							9.6
		1350			◆							
<b>soundshield</b>	10	1200				◆			◆	8.4		
		1350				◆			◆			
	13	1200			◆							12.3
<b>opal</b>	10	1200							◆	8.4		
		1350							◆			
<b>curveshield</b>	6.5	1200				◆				4.6		

• Stock item - except WA ◆ Stock item in some locations only - except WA

+ Available in Square Edge/Recessed Edge in some locations only.

Weights indicated are nominal. Check website for the most up to date information.

Other sizes available, minimum order quantity and lead times apply.

Recessed/Recessed edge types are standard. Other edge types (Square/Recessed, Square/Square) are available, minimum order quantity and lead times apply.



Water Resistant



Sound Resistant



Impact Resistant



Interior Design



Certified by Global GreenTag to a GreenRate Level A



Carbon Neutral Program



## Jointing Compounds and Specialty Plasters

Name	Size	Type	Application			Wet Areas Under Tiles
			Bedding	Second	Finish	
<b>Bedding Cements</b>						
<b>mastabase</b>	10 kg bag 20 kg bag	Powder	✓	✓		✓
<b>mastalongset</b>	20 kg bag	Powder	✓	✓		✓
<b>Finishing Compounds</b>						
<b>mastaglide</b>	20 kg bucket	Premixed			✓	X
<b>All Purpose Compounds</b>						
<b>mastalite</b>	17 kg bucket	Premixed	✓	✓	✓	X
<b>mastaline</b>	20 kg bucket	Premixed	✓	✓	✓	X
<b>box ready mastaline</b>	20 kg bucket	Premixed	✓	✓	✓	X
<b>mastatape-in</b>	20 kg bucket	Premixed	✓	✓	✓	X
<b>mastacoat3</b>	4kg bucket	Premixed	✓	✓	✓	X
<b>Specialty Compounds</b>						
<b>mastafix20</b>	10 kg bag	Powder	✓	✓	✓	plus Corncicing and Patching
<b>mastablock</b>	20 kg bag	Powder	Back-blocking			

## Adhesives

Name	Size	Type	Application
<b>mastabond</b>	20 kg bag	Powder	Masonry walls
<b>mastagrip</b>	600 ml foil tube 1.25 kg bucket 5.2 kg bucket	Acrylic	Timber, treated timber and steel

**Cornice**

Name	Width (mm)	Length (mm)					Weight (kg/m)	Profile
		3000	3600	4200	4800	5400		
classiclook	55		.		.	.	0.65	
	75		.		.	.	1.05	
	90	.	.	.	.	.	1.30	
steplook2	55				.		1.41	
steplook3	75				.		1.93	
oceanlook	88				.		1.88	
reeflook	75				.		1.96	

**Plaster Cornice Cements**

Name	Size	Type	Setting Time	Application		
				Cornicing	Patching	Masonry Adhesive
			Minutes			
<b>Cornice Cements</b>						
mastacove45	20 kg bag	Powder	45	✓	✓	✓
mastacove75	20 kg bag	Powder	75	✓	✓	✓



## Battens

Profile		Depth	Width	BMT	Length	Code
	Domestic Batten	16	35	0.38	4800	FCDB-48
					6000	FCDB-60
	Back Blocking Batten	16	35	0.38	300	FCBBB-0300
	Cyclonic Batten	22	30	0.42	6100	FCCB22-61
	35mm Batten	35	35	0.42	4800 •	FCCB35-48
					6000 •	FCCB35-60

## Domestic Batten Clips

Clip	Name	Code
	Domestic Batten Direct Fix Clip 80mm drop	CDB26-80
	Domestic Batten Direct Fix Clip 150mm drop	CDB26-150
	Domestic Batten Anchor Clip	CDB37
	Domestic Batten to Top Cross Rail Clip	CDB39
	Domestic Batten Joiner	CDB38

## Top Hat Cleats

Image	BMT	Length	Width	Depth	Code
	2.0	100	50	27 •	THC50/27
				37	THC50/37
				52 •	THC50/52
			75	37 •	THC75/37
				52 •	THC75/52

## Top Hats

Profile	Width	Depth	BMT	Length	Code
	50	15	0.75	3600	TH50/15-075-36
			1.15	3600	TH50/15-115-36
				6000	TH50/15-115-60
	50	25	0.75	3600	TH50/25-075-36
			1.15	3600	TH50/25-115-36
				6000	TH50/25-115-60
	50	35	0.75	3600	TH50/35-075-36
				6000	TH50/35-075-60
				7200	TH50/35-075-72
			1.15	3600	TH50/35-115-36
				6000	TH50/35-115-60
				7200	TH50/35-115-72

## Steel Angles

Profile	Width	BMT	Length	Code	
	Backing Angles	35 x 35	0.7	3000	BA35-070-30
			3600	BA35-070-36	
		50 x 50	0.7	3000	BA50-070-30
				3600	BA50-070-36
			1.15	3000	BA50-115-30
		75 x 75	1.15	3000	BA75-115-30
100 x 100	1.15	3000 •	BA100-115-30		
	Utility Angles	28 x 28	0.3	2400	BA28-030-24
		40 x 40	0.3	1800	BA40-030-18

All dimensions are in mm. • Minimum order quantity and lead times apply





### Steel Angles

Profile	Name	Width	BMT	Length	Code
	External 90 angle	30	0.38	2400	P90EX24
				2550	P90EX26
				2700	P90EX27
				3000	P90EX30
				3600	P90EX36
	External 135 angle	30	0.38	2400	P135EX24
				2700	P135EX27
				3000	P135EX30
				3600	P135EX36
	Internal 90 angle	30	0.38	2400	P90INT24
				2700	P90INT27
				3000	P90INT30
				3600	P90INT36
	Internal 135 angle	30	0.38	2400	P135INT24
				2700	P135INT27
				3000	P135INT30
				3600	P135INT36

### Stopping Angles

Profile	Name	Depth	BMT	Length	Code
	Stopping Angle	10	0.38	3000	PSA1030
		13			PSA1330
		16			PSA1630
		20			PSA2030
	Shadowline Stopping Angle	6	0.38	3000	PSASL0630
		10		3000	PSASL30

### Beads

Profile	Name	Depth	BMT	Length	Code
	Plaster Stopping Bead	6	0.5	3000	PSB0630
		10		3000	PSB1030
		13		3000	PSB1330
		16		3000	PSB1630
	Plaster Casing Bead	6	0.5	3000	PCB0630
		10		3000	PCB1030
		13		3000	PCB1330
		16		3000	PCB1630

### Archway Bead

Profile	Name	Width	BMT	Length	Code
	Plaster Archway Bead	30	0.38	3000	PAWB30

### Render Beads

Profile	Name	Width	BMT	Length	Code
	Render Bead 1.5	32	0.38	2400	RB1.5/24
				2700	RB1.5/27
				3000	RB1.5/30
	Render Bead 2.5	55	0.55	2400	RB2.5/24
				2800	RB2.5/28
	Render Bead 4.5	55	0.55	2400	RB4.5/24
				2800	RB4.5/28

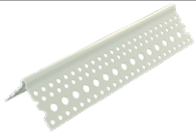
### Reveal Angles

Profile	Width	BMT	Length	Code
	20	0.8	3000	PLRA2030
			3600	PLRA2036
	25		3000	PLRA2530
			3600	PLRA2536
	30		3000	PLRA3030
			3600	PLRA3036
	35		3000	PLRA3530
			3600	PLRA3536
	40		3000	PLRA4030
			3600	PLRA4036
	45		3000	PLRA4530
			3600	PLRA4536
	50		3000	PLRA5030
			3600	PLRA5036
	60		3000	PLRA6030
			3600	PLRA6036
	65		3000	PLRA6530
			3600	PLRA6536
	75		3000	PLRA7530
			3600	PLRA7536
	80		3000	PLRA8030
			3600	PLRA8036
	90		3000	PLRA9030
			3600	PLRA9036
100	3000	PLRA10030		
	3600	PLRA10036		
110	3000	PLRA11030		
	3000	PLRA12030		
120	3000	PLRA13530		
	3000	PLRA15030		
135	3000	PLRA15030		
	3600	PLRA15036		


All dimensions are in mm. • Minimum order quantity and lead times apply




## PVC Angles

Profile	Name	Width	Gauge	Length	Code
	PVC 90° External Angle	32	1.2	2400	PVCP90EX24
				2700	PVCP90EX27
				3000	PVCP90EX30


## PVC Expansion Joint

Profile	Name	Gauge	Length	Code
	PVC Expansion Joint	1.2	3000	PVCXJ30



## PVC Tearaway Beads

Profile	Name	Width	Gauge	Length	Code
	PVC Tearaway Bead	32	1.2	3000	PVCTAWAYBD10/30
	PVC Shadowline 10mm Tearaway Bead	32	1.2	3000 •	PVCTAWAYBD10/30SL


## PVC Render Beads

Profile	Name	Width	Gauge	Length	Code
	External Render Trim Bead 2.5mm	32	1.2	3000	PVCTRIMEX2.5/30
	External Render Trim Bead 3.5mm	32	1.2	3000	PVCTRIMEX3.5/30

## PVC Casing Beads

Profile	Name	Width	Gauge	Length	Code
	PVC Casing Bead 10mm	10	1.2	2400	PVCCB10-24
				3000	PVCCB10-30
	PVC Casing Bead 13mm	13	1.2	2400 •	PVCCB13-24
				3000 •	PVCCB13-30

## PVC Capping

Profile	Name	Width	Gauge	Length	Code
	External Capping 20mm	20	1.2	2400	PVCCA20-24
	External Capping 25mm	25	1.2	2400	PVCCA25-24

All dimensions are in mm. • Minimum order quantity and lead times apply



# Building with Lightweight Construction





BUILDING WITH LIGHTWEIGHT CONSTRUCTION	13
BENEFITS OF LIGHTWEIGHT CONSTRUCTION	13
<b>2.1 MATERIALS</b>	<b>13</b>
PLASTERBOARD	13
STEEL FRAMING	16
FASTENERS	21
<b>2.2 CARE AND USE</b>	<b>24</b>
STORAGE, DELIVERY AND HANDLING	24
WEATHER PROTECTION	25
CONDENSATION AND VENTILATION	25
EXPOSURE TO HIGH HUMIDITY	26
EXPOSURE TO WATER	26
EXPOSURE TO EXCESSIVE HEAT	26



## Building with Lightweight Construction

Etex Australia offers a wide range of solutions for lightweight construction including metal framing, plasterboard linings, ceiling tiles, adhesives, jointing compounds, fire sealant and cornice.

Siniat wall and ceiling linings are available with a wide range of properties for different applications from impact resistant plasterboard to aesthetic ceiling linings that absorb sound.

Along with providing these solutions, Siniat offers a suite of Knowhow services to help bring your project to life from instant online calculators and system selectors to personal technical advice and all backed by a 10 year Siniat warranty.

## Benefits of Lightweight Construction

When combined together, lightweight materials provide effective composite performance; the result is a vast range of combinations so the desired performance can be tailor made for construction. Lightweight construction is so called because it can achieve heavy weight performance while decreasing the weight and cost of the entire building.

A typical lightweight wall construction consists of either steel or timber framing, insulation and plasterboard or other lining board.

Siniat steel studs are an efficient way of providing framing for plasterboard and other lining materials.

Combine with Fletcher Insulation's acoustic and thermal insulation the enhance the performance of walls and ceilings.

# 2.1 Materials

## Plasterboard

Plasterboard is made from a core of a naturally occurring mineral called gypsum, also known as calcium sulphate dihydrate or  $\text{CaSO}_4 \cdot 2\text{H}_2\text{O}$ . The core is sandwiched between two layers of heavy duty recycled paper. The face paper is suitable for painting or wallpaper. Plasterboard has square profile cut ends and long recessed edges to enable easy jointing.

Etex Australia manufactures plasterboard to strict internal standards which meet or exceed the requirements of *AS/NZS 2588:2018, Gypsum Plasterboard*.

The Australian Standard for plasterboard installation is *AS/NZS 2589:2017, Gypsum linings – Application and finishing*.

Plasterboard is suitable for use as an interior wall and ceiling lining, and also for external ceilings when protected from the weather. For more information about the suitability of plasterboard, please refer to Section 2.2 Care and Use.

## Environment Benefits

Plasterboard is an ideal product for sustainable construction. As a lightweight building material, plasterboard reduces transport costs and emissions as well as the total weight of buildings. Plasterboard is 100% recyclable, with low embodied energy, and made largely from a naturally occurring mineral – gypsum. The liner paper used to make plasterboard is biodegradable and made from recycled paper such as waste newspaper and cardboard.

The plasterboard manufacturing process operates under strict environmental guidelines:

- > Efficient use of energy and water including heat recovery and storm water collection
- > Effective collection and monitoring of dust.
- > Ongoing waste and raw material usage reduction.
- > Minimisation of plant impact on surroundings.

Since 2009, Etex Australia has introduced a number of initiatives to reduce carbon emissions which has also resulted in the first certified carbon neutral opt in program for plasterboard.

Combining plasterboard with lightweight framing such as timber or steel provides a vast array of system performances, which can be efficiently gauged to the precise needs of any project.



Lightweight steel framing is both strong and durable, and like plasterboard has the potential to be fully recycled at end of life.

For more information refer to:  
[siniat.com.au/sustainability](http://siniat.com.au/sustainability)

## Fire Resistance

All plasterboard is naturally fire resistant. The core slows down the spread of fire by releasing chemically bound water when heated. This is a similar process to evaporation and aids cooling.

## Fire Hazard Properties

The National Construction Code (NCC) regulates the fire hazard properties of coverings and lining materials in buildings according to NCC 2022 Volume One, C2D11. Floor linings and coverings must have a high enough critical radiant flux to comply with NCC 2022 Volume One, C2D11, while wall and ceiling linings must have a low enough group number. The group number indicates how quickly wall and ceiling linings spread fire, with Group 1 products ranked the slowest and Group 4 the fastest.

**Table 1 Product Group Number**

Product	Group Number	Average Specific Extinction Area (m <sup>2</sup> /kg)
Curveshield	1	less than 250
Creason	1	less than 250
Createx	1	less than 250
Fireshield	1	less than 250
Intershield	1	less than 250
Mastashield	1	less than 250
Multishield	1	less than 250
Opal	1	less than 250
Shaftliner	1	less than 250
Soundshield	1	less than 250
Spanshield	1	less than 250
Trurock	1	less than 250
Trurock HD	1	less than 250
Watershield	1	less than 250

## Fire Hazard Property Report



## Fire Hazard Properties and Combustibility



## Combustibility

Plasterboard is considered to limit the spread of fire; therefore in accordance with NCC 2022 Volume One, C2D10 (6) (a), plasterboard may be used wherever non-combustible materials are required.

## Thermal 'R' Value

The R-Value of plasterboard is a measure of its thermal insulation ability. Higher numbers indicate a better insulator. The values\* for plasterboard are:

- > 10mm plasterboard = 0.059 m<sup>2</sup>.K/W
- > 13mm plasterboard = 0.076 m<sup>2</sup>.K/W
- > 16mm plasterboard = 0.094 m<sup>2</sup>.K/W

\*Values calculated from thermal conductivity of plasterboard listed in NCC of 0.17 W/mK

## Specific Heat Capacity

Specific heat capacity is the amount of heat energy required to raise the temperature of 1 kg of material by 1°C.

- > Plasterboard is 1090 J/kg.K.

## Dimensional Stability

Plasterboard is dimensionally stable when compared to other building materials. Two measures of dimensional stability are listed below:

- > Thermal coefficient of linear expansion ( $\alpha$ ) =  $16.7 \times 10^{-6}$  m / °C, measured unrestrained over the temperature range of 3°C – 32°C
- > Hygrometric coefficient of expansion =  $6.5 \times 10^{-6}$  / %RH, measured unrestrained over the Relative Humidity (RH) range of 10% – 90%.

## Safety

Plasterboard is not classified as hazardous according to the criteria of Safe Work Australia. It is non-toxic and non-flammable.



## Maintenance

Plasterboard is a product that is typically installed as a substrate for further decoration like painting, wall paper or tiles. As such, the requirements for maintenance of plasterboard are usually less compared to the decorative finish.

Where paint is used as the decorative finish, the paint manufacturer's recommendations should be followed for maintenance and cleaning. Similarly, if wall paper or tiles are used then recommendations from the manufacturer should be followed. This relates to the cleaning procedures and the suitable materials/products that should be used.

Maintenance of plasterboard is likely to be necessary only as required. Otherwise, annual checks are recommended on wall and ceiling systems to assess whether maintenance is required for:

- > Physical damage (dents, scratches)
- > Structural damage (cracks, compression fractures)
- > Fire or excessive heat damage
- > Water damage (including moisture affected plasterboard and mould growth, etc)
- > Re-painting (as and when desired)
- > Cleaning (as and when desired)

If repairs are required, then they must be conducted in a way that maintains the installation requirements of *AS/NZS 2589:2017 Gypsum Linings – Application and Finishing*, *AS 2785-2020 Suspended Ceilings - Design and installation*, and for fire rated systems in accordance with Siniat technical literature.

### OnBoard - Maintaining Plasterboard



## Durability

The durability of Siniat plasterboard and its ability to perform as a wall or ceiling lining depends on several factors, some include:

- > Ventilation of the building (and HVAC system) with the ability to control moisture and condensation
- > Amount of humidity and air flow
- > Decorative covering (paint, wall paper, tiles)
- > Use of building wall wraps, roof sarking and vapour barriers
- > Frequency and duration of wet and damp conditions (ie. water leaks)
- > Mould growth
- > Temperature range experienced
- > Movement from substrate framing
- > Allowance for framing movement (with control joints)
- > Maintenance intervals.



## Steel Framing

Siniat light-weight steel framing is an economical, durable and efficient way of providing the necessary support for a range of internal wall and ceiling linings as well as external cladding and brick veneer. Etex Australia manufactures a comprehensive range of steel framing components for a range of systems including:

- > Non-load bearing steel stud wall framing
- > Concealed and exposed ceiling framing with associated clips
- > Steel stud ceilings
- > Top hat and façade systems
- > Jamb stud and associated brackets for openings in walls
- > Acoustic studs
- > Access panels, and
- > Plaster finishing accessories.

Bluescope Steel is our supplier of large steel coils which are slit, then cold rolled to form the Siniat steel profiles in our manufacturing plant in Beenleigh, Queensland. The steel coils comply with:

- > *AS/NZS 1365:1996 Tolerances for flat-rolled steel products, and*
- > *AS 1397: 2011 Continuous hot-dip metallic coated steel sheet and strip - Coatings of zinc and zinc alloyed with aluminium and magnesium.*

Certification for systems in this manual have been based upon Siniat branded steel products. If other manufacturer's products have been used for the framing, it is the responsibility of that manufacturer to prove equivalent performance of the system and provide the associated certification.

**Table 2 Steel Grade and Corrosion Protection Coating**

Profile	Grade	Ultimate Stress (MPa)	Yield Stress (MPa)	Coating
Studs, Head and Base Tracks, Nogging Tracks, Top Hats, Top Cross Rails	G300	340	300	AM150 / AM125
Furring Channel, Domestic Batten, 22mm Cyclonic Batten, 35mm Batten	G550	550	550	AM150
Jamb Stud	G450	480	450	Z350
Hanging rods and brackets: UB60, UB80, DB, JSCB, SB45, SCB and Top Hat Cleats	G250	320	250	Z275
All other clips not listed above (except Interhome aluminium clip or zinc electroplated clips)	G300	340	300	AM150

## Combustibility

Steel is considered to limit the spread of fire; therefore in accordance with NCC 2022 Volume One, C2D10 (5) (b), steel may be used wherever non-combustible materials are required.

## Early Fire Hazard Indices

Ignitability Index (0-20)	Spread of Flame Index (0-10)	Heat Evolved Index (0-10)	Smoke Developed Index (1-10)
0	0	0	2

1. Zincaulme steel
2. Test certificate FNE11602

## Safety

Not classified as hazardous according to the criteria of Safe Work Australia. It is non-toxic and non-flammable.

## Corrosion Protection

Siniat steel framing has a corrosion protection coating applied to the surface for enhanced durability. Etex Australia supplies Siniat branded products with the following corrosion protection:

- > Zinalume® AM150 and AM125 (aluminium / zinc / magnesium) as per AS 1397 for wall studs, top and bottom tracks, wall noggings, furring channels, top cross rails, top hats and most accessories other than listed below.
- > Galvaspan® Z350 (zinc) as per AS 1397 for Jamb Stud.
- > Galvanised Z275 (zinc) as per AS1397 for ceiling hanging rods, and the following wall framing brackets: UB60, UB80, DB, JSCB, SB45, SCB and Top Hat Cleats.
- > Zinc electroplated with clear passivate (Class 1 designation A trivalent chromate) for the following clips C24, C54, C60, C60DF, C60LDF, C61S, C66, C126 and part of C52.





## Durability

The durability of Siniat steel products and their ability to perform the intended function for a particular application depends on the severity of exposure. There are many factors related to the severity of exposure, some include:

- > Geographical location (ie: near breaking surf or near heavy industry)
- > Location on a building
- > Construction system the product is used in
- > Use of building wall wraps, roof sarking and vapour barriers
- > Type of external cladding / roof lining used
- > Ventilation of the building (and HVAC system) with the ability to control moisture and condensation
- > Amount of humidity and air flow
- > Exposure to salt air and chlorine laden air
- > Frequency and duration of wet and damp conditions (ie. water leaks)

- > Horizontal surfaces where water, dust or other contaminants like salt may pool
- > The ability of the member to be cleaned by rainwater or hosing
- > Maintenance intervals.

Siniat steel framing must be effectively separated from the external environment once installed. In addition, they must be installed to enable drying and prevent long periods of wetness. Extended exposure to high moisture may lead to some level of surface corrosion or staining, as such a regular inspection and maintenance schedule is recommended.

For applications not covered in this manual, additional corrosion protection coatings may need to be applied for certain applications or to prolong the intended service life. Siniat steel products do have industry leading factory applied corrosion protection, and they may be suited to other applications not listed in this section. Please consult a corrosion expert for advice.

**Table 3 Suitability of Siniat Zinalume® Steel Products**

Application		Geographical Location	
		Further than 300m from breaking surf and above 50m from calm salt water. (AS4312 corrosion category ≤ C4)	Between 100 – 300m from breaking surf, and between 10 – 50m from calm salt water.
Walls	Internal wall framing	✓	✓*
	Internal wall framing for a building with outer wall wrap	✓	✓*
	External wall framing (including top hats) behind external cladding	✓	X
	External wall framing (including top-hats) behind wall wrap and external cladding	✓	✓
	Vertical top hats outside of outer wall wrap but under external cladding with a drained and vented cavity <sup>^</sup>	✓	✓ <sup>#</sup>
	Vertical top hats outside of outer wall wrap but under external cladding with a drained and ventilated cavity <sup>^</sup>	✓	X
Ceilings	Ceiling framing under a concrete slab	✓	✓*
	Ceiling framing under a roof	✓	X

\* Based on full internal encapsulation with no uninhibited air flow from outside of the building envelope.

# Performance is expected to vary based on the type of external cladding used.

<sup>^</sup> Ventilated cavity is open at the top and bottom allowing continuous airflow behind cladding. Vented cavity is only open at the bottom.

1. Table applicable to all Siniat Zinalume® coated steel products for a minimum expected life of 15 years under normal conditions (excluding indoor swimming pools and spas). Actual service life may increase or decrease depending on the factors outlined in the section titled 'Durability'.
2. All galvanised products must be used further than 300m from breaking surf and further than 50m from calm salt water.
3. Water must not be permitted to pool on surfaces and must be designed and installed to drain freely.
4. The outer wall wrap and roof sarking must be suited to the climate zone.
5. Foil backed insulation must be used under a metal roof to prevent condensation forming on the roof sheeting.
6. Regular recorded inspections must be conducted with any rectification measures actioned.
7. Fasteners must have a suitable corrosion protection coating to match the application. Refer to Tables 9 and 10 for more information.
8. Stainless steel screws are not recommended with Siniat steel framing.
9. Refer to 'Intensive Animal Farming and Industrial Buildings' and 'Indoor Swimming Pools and Spas' sections for further restrictions.



## Corrosivity Zones

AS 4312-2019 *Atmospheric corrosivity zones in Australia*, classifies geographical zones within Australia based upon the theoretical first year atmospheric corrosion rate of mild steel open to exposure.

Actual corrosion rates depend on the severity of exposure, and these zones are a practical indication of the potential severity of the location to corrosion. This standard does not indicate which corrosion protection coatings must be used for certain locations.

As Siniat steel profiles must be effectively separated from the external environment once installed, the corrosivity zones are much less relevant. Refer to Table 3 for the use of Siniat products for the geographical location and intended application.

## Intensive Animal Farming and Industrial Buildings

Certain micro environments have been found to be particularly corrosive such as intensive animal farming buildings. These buildings create an environment with high concentrations of sulphur and ammonia and as such are not suitable for Siniat steel products without the application of additional corrosion protection measures.

Industrial buildings and the like, and surrounding locations that are subject to heavy dust emissions, excessive heat, excessive moisture, corrosive chemicals or acids, fertilizer manufacturing and storage, near the combustion of fossil fuels are also micro environments which will require further advice before the use of Siniat steel products.

Please consult a corrosion expert for advice for these applications.

## Indoor Swimming Pools and Spas

The overall design and maintenance plan of a facility affects the long term durability of the building products used in the construction. Other factors like humidity levels, ventilation, temperature, chemical cleaning treatment (chlorine) and proximity of the pool to walls and ceilings also affect durability. Although these factors are outside the control of Etex Australia (Siniat), they are critical to protecting steel framing from the corrosive atmosphere of an indoor swimming pool and spa.

Individual site conditions may require specific measures therefore consultants such as HVAC specialists, corrosion experts and building physicists are recommended.

Minimum requirements to use Siniat AM125, AM150 or Z275 coated steel products for concealed indoor swimming pool wall and ceiling framing:

- > A slight negative pressure must be maintained in the pool room relative to the wall and ceiling spaces. This reduces the driving force of moisture into the wall or ceiling cavity where the framing is located.
- > Ventilation systems must continuously circulate air and be vented to the outside only. The ceiling plenum must not be used for return air.
- > Use a minimum of Class 3 corrosion resistant screws appropriate for the lining and also compatible with the steel framing. Please note that stainless steel screws are not recommended with Siniat steel framing.
- > Vapour barriers between the wall and ceiling framing and the indoor pool room must be continuous and sealed at all joints and penetrations. Any following trades must re-seal any penetrations in the vapour barriers. The purpose of the vapour barrier is to prevent water vapour from the swimming pool or spa passing through the wall or ceiling lining into the cavity, where it may turn into condensation (liquid form).
- > Allow wall and ceiling cavities to dry by using ventilation to the outside and vapour permeable membranes under any external claddings.
- > Thermal insulation with vapour barrier must be installed under sheet roofing. This is to prevent condensation dripping onto the steel framing. Sarking must be installed under tiled roofs to reduce pressure fluctuations within the roof space which may draw air in from the pool area.
- > Periodically inspect the steel framing for the appearance of rust and replace if detected or consult a corrosion specialist.

Zinc electroplated ceiling clips are not recommended for use in indoor swimming pools.



## Dissimilar Metals

When dissimilar metals (active and noble metals) come into contact along with the presence of an electrolyte such as water they corrode via galvanic action. This is also known as galvanic corrosion or bi-metallic corrosion.

Copper, stainless steel, brass and lead are just some of the metals that can cause galvanic corrosion when in contact with Zinalume®, Galvaspan® or galvanised steel. Therefore, copper pipes, lead flashing and the like must not come in direct contact with Siniat steel products. Also any water flowing from lead flashing or copper pipes onto Siniat steel products shall be prevented.

**Table 4 Compatibility of Siniat Steel**

Coating / Metal	AM150 / AM125	Z350
Zinc (Z), Aluminium/Zinc (AZ), Aluminium/Zinc/Magnesium (AM, ZAM)	Compatible	Compatible
Aluminium	Compatible	Compatible
Copper, Stainless Steel or Zinc Nickel coated steel	Not suitable	Not suitable

## Termite Treated Timbers

Green timber and Copper Chrome Arsenic (CCA) treated timbers must not come into direct contact with Siniat steel products. Either they must be isolated or an alternative kiln dried timber treatment compatible with galvanised or Zinalume® corrosion protection must be used.

## Specific Heat Capacity

Steel is 490 J/kg/K.

## Dimensional Stability

Thermal coefficient of linear expansion  
( $\alpha$ ) =  $12 \times 10^{-6}$  m / °C, measured unrestrained at a temperature of 25 °C

## Maintenance

Maintenance can help extend the service life of steel framing and it is likely to be necessary only as required. Annual checks are recommended on wall, ceiling and facade systems to assess whether maintenance is required for:

- > Physical damage
- > Fire or excessive heat damage
- > Corrosion
- > Cleaning (as and when desired)

If repairs are required, then they must be conducted in a way that maintains the structural integrity of the original frame. Also, if new materials are introduced with any repairs then they must be compatible with the existing framing.

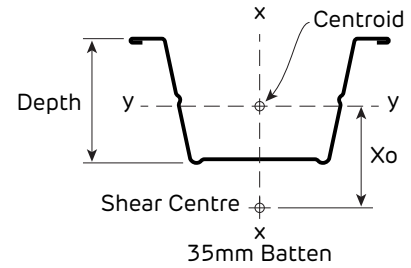
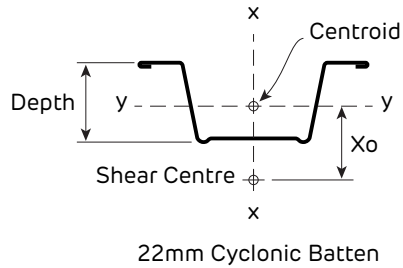
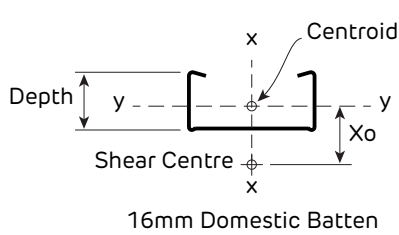


## Steel Profile Information

### Material

Manufacturer	Item	Grade	Ultimate	Yield	Coating
Siniat	16mm Domestic Batten	G550	550 MPa	550 MPa	AM150
	22mm Cyclonic Batten	G550	550 MPa	550 MPa	AM150
	35mm Batten	G550	550 MPa	550 MPa	AM150

1. Steel grade and coating in accordance with AS 1397 *Continuous hot-dip metallic coated steel sheet and strip*



### Section Properties

Profile	Dimensions (mm)		Shear Centre from Centroid (mm)	Area (mm <sup>2</sup> )	Moment of Inertia (mm <sup>4</sup> )		Section Modulus (mm <sup>3</sup> )		Torsion Constant J (mm <sup>4</sup> )	Warping Constant I <sub>w</sub> (mm <sup>6</sup> )
	Depth	BMT			X <sub>o</sub>	I <sub>xx</sub>	I <sub>yy</sub>	Z <sub>xx</sub>		
16mm Domestic Batten	16	0.38	-12.44	28.0	5,399	977	311	94	1.36	265,670
22mm Cyclonic Batten	22	0.42	-17.71	46.5	15,480	3,557	495	329	2.56	355,760
35mm Batten	35	0.42	-28.11	56.9	28,908	10,161	803	544	3.35	1,301,900

## Fasteners

Fasteners used to fix Siniat steel framing products and accessories must be compatible and also have equivalent corrosion protection for the service life of the entire system.

As Siniat steel profiles are roll formed using Zinalume®, Galvaspan® or galvanised corrosion protection coatings, they are particularly compatible with zinc coated fasteners. The zinc layer acts as a sacrificial anode which protects the steel from corrosion.

When using any fastener with Siniat steel profiles, it is essential that there is limited exposure to moisture during service. If the screws or studs come into





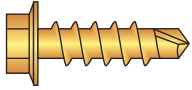
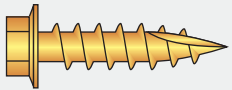
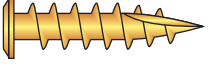
contact with moisture, ensure that all moisture can dry out quickly beneath fastener heads or around washers (if used).

Please note that stainless steel screws are not recommended with Siniat steel framing, or alternatively seek expert advice on corrosion and compatibility prior to use.

Green timber and certain treated timbers such as Copper Chromium Arsenate (CCA) treated timbers are corrosive to steel fasteners, especially in combination with moisture.

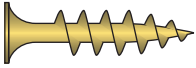
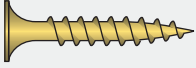
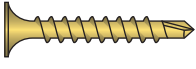
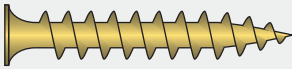


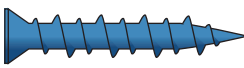
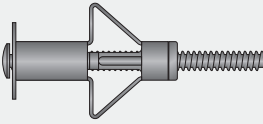
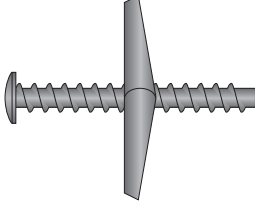
Consult the manufacturer for specific advice on the appropriate fasteners for the application and environmental conditions.

**Table 5 Typical Steel Framing Fasteners Table**

Typical Applications	Image	Features	Typical Sizes Available
			Screw gauge - Threads per inch x Length
Steel framing screw 0.75 - 2.50mm BMT. Recommended for Siniat 0.3 - 0.75mm BMT profiles.		<ul style="list-style-type: none"> <li>• Button head</li> <li>• Fine thread</li> <li>• Drill point</li> </ul>	8 - 18 x 12mm 8 - 18 x 16mm 8 - 18 x 20mm 8 - 18 x 25mm 8 - 18 x 32mm
Steel framing screw 0.75 - 3.50mm BMT. Recommended for Siniat 1.15 - 1.5mm BMT steel profiles.		<ul style="list-style-type: none"> <li>• Wafer head</li> <li>• Fine thread</li> <li>• Drill point</li> </ul>	10 - 16 x 16mm 10 - 16 x 22mm 10 - 16 x 30mm 10 - 16 x 40mm
Steel framing screw 0.75 - 3.0mm BMT. Recommended for Siniat 1.15 - 1.5mm BMT steel profiles.		<ul style="list-style-type: none"> <li>• Flat head</li> <li>• Fine thread</li> <li>• Drill point</li> </ul>	10 - 16 x 16mm 10 - 16 x 22mm 10 - 16 x 30mm
Steel framing screw 0.75 - 3.50mm BMT. Recommended for Siniat 1.15 - 1.5mm BMT steel profiles.		<ul style="list-style-type: none"> <li>• Hex head</li> <li>• Fine thread</li> <li>• Drill point</li> </ul>	10 - 16 x 16mm 10 - 16 x 25mm
Steel framing screw 1.00 - 4.50mm. Recommended for Siniat 1.15 - 1.5mm BMT steel profiles.		<ul style="list-style-type: none"> <li>• Hex head</li> <li>• Fine thread</li> <li>• Drill point</li> </ul>	12 - 14 x 20mm 12 - 14 x 30mm 12 - 14 x 35mm 12 - 14 x 45mm 12 - 14 x 55mm 12 - 14 x 65mm 12 - 14 x 75mm
Steel framing to timber		<ul style="list-style-type: none"> <li>• Hex head</li> <li>• Coarse thread</li> <li>• Type 17 point</li> </ul>	10 - 12 x 25mm 12 - 11 x 25mm 12 - 11 x 40mm 12 - 11 x 50mm 12 - 11 x 65mm
Steel framing to timber		<ul style="list-style-type: none"> <li>• Wafer head</li> <li>• Coarse thread</li> <li>• Type 17 point</li> </ul>	10 - 12 x 25mm 10 - 12 x 35mm 10 - 12 x 45mm

1. Information in the table is supplied by ICCONS Pty Ltd, unless otherwise noted. Other fastener / anchor manufacturers product specifications may vary.
2. Refer to the manufacturer's technical literature for the correct in-situ applications, corrosion class and capacity information of a specific fastener or anchor.
3. For external wall framing use screws with a minimum corrosion resistance of Class 3.
4. Drawings are representative only.


**Table 6 Typical Plasterboard and Fibre Cement Fasteners Table**

Typical Applications	Image	Features	Typical Sizes Available
			Screw gauge - Threads per inch x Length
Plasterboard to timber		<ul style="list-style-type: none"> <li>• Coarse thread</li> <li>• Bugle head</li> <li>• Needle point</li> </ul>	6 - 9 x 25mm 6 - 9 x 32mm 6 - 9 x 41mm 8 - 9 x 45mm 8 - 9 x 50mm 8 - 9 x 75mm
Plasterboard to timber or steel up to 0.75mm BMT		<ul style="list-style-type: none"> <li>• Fine thread</li> <li>• Bugle head</li> <li>• Needle point</li> </ul>	6 - 18 x 20mm 6 - 18 x 25mm or 7 - 15 x 25mm 6 - 18 x 32mm or 7 - 15 x 32mm 6 - 18 x 35mm 6 - 18 x 41mm 6 - 18 x 45mm or 7 - 15 x 45mm 7 - 15 x 50mm 7 - 15 x 57mm 8 - 15 x 65mm 8 - 15 x 75mm 10 - 12 x 100mm
Plasterboard to steel 0.75mm to 2.30mm BMT		<ul style="list-style-type: none"> <li>• Fine thread</li> <li>• Bugle head</li> <li>• Drill point</li> </ul>	6 - 20 x 25mm 6 - 20 x 32mm 6 - 20 x 41mm 6 - 20 x 45mm 8 - 18 x 75mm (up to 2.50mm BMT)
Plasterboard laminating screw		<ul style="list-style-type: none"> <li>• Coarse thread</li> <li>• Bugle head</li> <li>• Needle point</li> </ul>	10 - 8 x 38mm 10 - 8 x 50mm
Fibre cement to steel up to 0.75mm BMT		<ul style="list-style-type: none"> <li>• Self embed head</li> <li>• Needle point</li> </ul>	8 - 15 x 20mm 8 - 15 x 30mm
Fibre cement to steel 0.75mm to 2.30mm BMT		<ul style="list-style-type: none"> <li>• Fine thread</li> <li>• Self eambed head</li> <li>• Drill point</li> </ul>	8 - 15 x 20mm 8 - 15 x 30mm
Plasterboard to masonry or concrete		<ul style="list-style-type: none"> <li>• Tapcon thread</li> <li>• Countersunk head</li> <li>• Needle point</li> </ul>	10 x 32mm 10 x 45mm 14 x 55mm 14 x 70mm
Hollow Wall Anchor		<ul style="list-style-type: none"> <li>• Fine thread</li> <li>• Pan head</li> </ul>	Various
Spring Toggle		<ul style="list-style-type: none"> <li>• Fine thread</li> <li>• Pan head</li> </ul>	1/8" x 50mm 1/8" x 75mm 3/16" x 50mm 3/16" x 75mm 3/16" x 100mm

1. Information in the table is supplied by ICONNS Pty Ltd, unless otherwise noted. Other fastener / anchor manufacturers product specifications may vary.
2. Refer to the manufacturer's technical literature for the correct in-situ applications, corrosion class and capacity information of a specific fastener or anchor.

**Table 7 Screw Type and Minimum Size for the Installation of Plasterboard to Steel**

Plasterboard Thickness	1st Layer	2nd Layer	3rd Layer
6.5mm	6g x 25mm screw	6g x 25mm screw	-
10mm	6g x 25mm screw	6g x 41mm screw *	-
13mm	6g x 25mm screw	6g x 41mm screw *	7g x 57mm screw *

For steel  $\leq$  0.75mm BMT, use fine thread needle point screws.

For steel  $\geq$  0.75mm BMT, use fine thread drill point screws.

\*10g x 38mm Laminating screws may be used as detailed in installation diagrams.

**Table 8 Fastener Type and Minimum Size for the Installation of Plasterboard to Softwood Timber**

Plasterboard Thickness	1st Layer	2nd Layer	3rd Layer
6.5mm	2.8 x 30mm galvanised nail or 2.8 x 25mm ring shank nail or 6g x 25mm screw	2.8 x 40mm galvanised nail or 2.8 x 30mm ring shank nail or 6g x 32mm screw	-
10mm	2.8 x 40mm galvanised nail or 2.8 x 30mm ring shank nail or 6g x 25mm screw for walls or 6g x 32mm screw for ceilings	2.8 x 50mm galvanised nail or 6g x 41mm screw *	-
13mm	2.8 x 40mm galvanised nail or 2.8 x 30mm ring shank nail or 6g x 32mm screw	2.8 x 50mm galvanised nail or 7g x 45mm screw *	3.75 x 75mm galvanised nail or 8g x 65mm screw *

Table refers to non-fire rated installation only.

\*10g x 38mm Laminating screws may be used as detailed in installation diagrams.

**Table 9 Recommended Fastener Corrosion Resistance Class - External**

Atmospheric corrosivity category	Typical distance <sup>3</sup> from breaking surf	Recommended Minimum Fastener Corrosion Class			
		External			
		Behind ventilated cladding system - unprotected	Behind ventilated cladding system - protected <sup>4</sup>	Behind vented cladding system	External ceilings
C2 (low)	Greater than 50km	Class 3	Class 2	Class 2	Class 2
C3 (medium)	Between 1km to 50km	Class 3	Class 3	Class 2	Class 3
C4 (high)	Between 300m to 1km, or greater than 50m from calm salt water	- <sup>2</sup>	Class 3	Class 3	Class 3
C5 (severe)	Between 100m to 300m, or between 10m to 50m from clam salt water	- <sup>2</sup>	Class 3	Class 3 if covered with wall wrap or external cladding soon after installation, otherwise cover with external grade sealant or use Class 4	- <sup>2</sup>

1. This table is a guide only for fasteners used with Siniat top hats, Multishield behind wall wrap or Weather Defence.

2. Obtain specialist advice if in doubt or for applications outside this table.

3. Distances are approximate. Refer to AS4312 for more detail and for specific locations.

4. Protected is defined as fasteners behind wall wrap, wall or ceiling cladding or covered with external grade sealant.

5. For industrial environments and the like, obtain specialist advice of appropriate fastener corrosion class.

6. Stainless steel screws are not recommended with Siniat steel framing.

**Table 10 Recommended Fastener Corrosion Resistance Class - Internal**

Atmospheric corrosivity category	Recommended Minimum Fastener Corrosion Class				
	Internal				
	Dry rooms	Rooms with intermittent high humidity <sup>3</sup>	Rooms with constant high humidity	Swimming pools and spas	
Unprotected				Protected <sup>4</sup>	
C1 (very low)	Class 1	Class 2	Class 3	Class 4	Class 3

1. This table is a guide only for fasteners used with Siniat plasterboard linings (except for unprotected swimming pools).

2. Obtain specialist advice if in doubt or for applications outside this table.

3. Includes internal wet areas and where condensation may occur.

4. Protected is defined as fasteners behind a wall or ceiling lining or covered with external grade sealant.

5. For industrial, intensive animal farming or food production environments and the like, obtain specialist advice of appropriate fastener corrosion class.

6. Stainless steel screws are not recommended with Siniat steel framing.



## 2.2 Care and Use

### Storage, Delivery and Handling

Wall and ceiling linings must be kept dry and should be stacked clear of the floor using supports not more than 600mm apart as shown in Figure 1. If outdoor storage is unavoidable, linings and accessories should be fully protected from the weather. Plasterboard that has been exposed to direct sunlight, or has been fixed and left unpainted for long periods, may become discoloured. If this happens, it must be sealed with a solvent borne stain sealer undercoat as recommended by the paint manufacturer.

Plasterboard ceilings should not be left unpainted as they may absorb moisture from the atmosphere and sag. Plasterboard finishing compound must not be left unpainted as it becomes susceptible to moisture absorption and can develop shrinkage defects or become powdery and flake off if painting is attempted.

To reduce the possibility of damage to plasterboard, arrange delivery to site immediately before installation. During delivery, care should be taken not to damage the surface or edges the plasterboard sheets.

Exposure to excessive humidity during storage can result in plasterboard becoming damp and soft, and may appear defective. In this case allow the plasterboard to dry out and handle with care during installation.

To help protect plasterboard from absorbing humidity:

- > Avoid open sources of water such as wet floors
- > Wrap the plasterboard with plastic overnight when storing outside
- > Provide ventilation
- > Install soon after delivery
- > Install during dry weather for best results.

Store Siniat steel products where they are not in constant contact with water or in wet environments for extended periods. Avoid exposure to airborne contaminants such as sea spray.

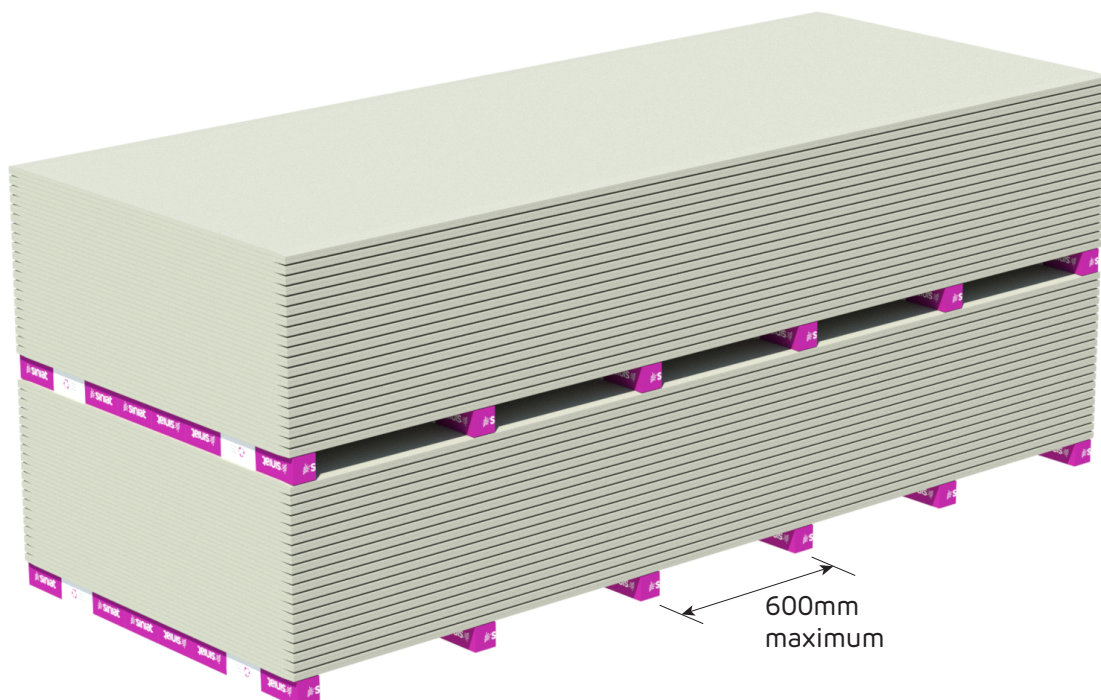


FIGURE 1 Correct Plasterboard Storage





## Weather Protection

Siniat plasterboard must only be installed in a building that is weathertight. Particular care must be taken in areas of high humidity and coastal areas subject to salt spray. Complete all exterior doors, walls, windows and the roof before installing plasterboard. Prevent rain from entering buildings, avoid water on floors or other sources of open water and allow wet concrete or masonry to dry. These precautions will reduce excessive humidity that may be absorbed by timber or unpainted plasterboard and minimise defects caused by timber shrinkage or moist plasterboard.

Siniat plasterboard installed on the exterior side of external wall framing must be protected from the weather until moisture barriers and external cladding are installed. Protect plasterboard from water pooling at ground level.

## Condensation and Ventilation

Condensation of water on a surface occurs when the temperature of a building element falls below the dew point temperature. Moisture from the air then condenses on the surface.

Condensation onto either the face or back of plasterboard and associated substrate framing must be avoided. Insufficient protection from condensation can result in plasterboard joint distortion, sagging, mould growth, fastener popping and corrosion on steel framing.

Many inter-related factors must be taken into account to control condensation. Good practice is to make use of wall and ceiling insulation, vapour barriers, and especially ventilation.

Siniat plasterboard and steel framing must only be installed in a well ventilated area. Ventilation is crucial to the longevity of all building materials as it controls the indoor air quality. Therefore appropriate ventilation must be considered for the spaces in walls, under floors and in particular under roofs and soffits.

Continuous ventilation in a wall or ceiling cavity near salt water may reduce the service life of any steel substrate framing. As such, vented wall and ceiling systems with only one opening are recommended. Fully ventilated building systems with multiple openings near salt water must be considered with caution.



To minimise the effects of condensation:

- > Use **watershield** to increase protection against moisture.
- > Use moisture barriers, sarking, and insulation. However, it is important that the right type is selected for the construction type and that it is installed correctly. [Refer to the manufacturer's specifications]
- > Use foil backed insulation under metal roofs which are susceptible to forming condensation.
- > Install eave vents, gable vents and roof ventilators in the roof cavity.
- > Remove humidity from bathrooms via an exhaust fan to the outside.
- > Use a quality paint system to provide protection against paint peeling and condensation soaking into plasterboard and compounds.
- > Ensure the building design controls condensation on the steel components so they are not constantly wet.

In hot and humid climates where the building is air-conditioned below the dew point of the outside air, the wall and ceiling framing members and internal linings should be fully protected by moisture barriers to separate them from the humid external air. The moisture barriers should be thermally insulated to maintain them at a temperature above the dew point.



## Exposure to High Humidity

Plasterboard exposed to high humidity (above 90%) for an extended period, may effect the plasterboards integrity and therefore its ability to perform its intended function.

For rooms with intermittent periods of high humidity such as bathrooms or basements where plasterboard is installed, a source of ventilation is required to enable removal of excess moisture, such as an open window or exhaust fan.

Ceilings in rooms such as indoor swimming pools and communal showers are subject to long periods of high humidity (above 90%). The use of plasterboard on these ceilings is not guaranteed by Etex Australia.

**watershield**, **multishield**, **trurock** or **trurock hd** completely covered with a waterproof membrane complying with *AS/NZS 4858:2004 Wet Area Membranes* may be used for walls in rooms subject to long periods of high relative humidity. Vertical junctions and wall to floor junctions must also be waterproof, refer to Section 3.3 Wet Areas.



In areas where high humidity is likely (ie: under concrete slabs with concrete block walls) consider closer framing intervals for ceiling linings to limit sag

## Exposure to Water

Plasterboard that has become wet during its service life must be assessed for damage and then either repaired or replaced. Plasterboard exposed to water can be assessed by anyone familiar with plasterboard such as plasterer.

The Onboard referred to below may be used as a guide for determining if the plasterboard needs repair or replacement.

### OnBoard - Assessing Wet Plasterboard



## Exposure to Excessive Heat

Plasterboard is an ideal building material for normal ambient temperatures. It is not suitable for long periods at elevated temperatures such as installed near fireplace flues or chimneys. Fire resistant plasterboard is no exception. It is designed to slow down a fire, not to resist constant elevated temperatures.

The effect of high temperatures on plasterboard is to chemically dehydrate the core. This process generally begins at around 80°C but can occur at lower temperatures under certain conditions.

*AS/NZS 2589:2017, Gypsum linings – Application and finishing*, states that plasterboard must not be exposed to temperatures above 52°C for prolonged periods.

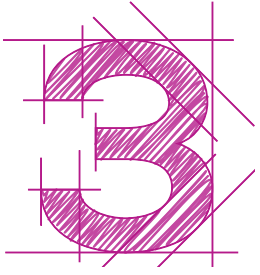
Heat generating appliances have installation instructions for the correct distances between plasterboard linings and heat sources. The *National Construction Code (NCC)* also has requirements for installation of heating appliances.

## Glass or Stainless Steel Splashback

*AS/NZS 5601.1-2013 General Gas Installations* allows plasterboard to be used behind splashbacks near domestic gas burners as follows:

- > Behind ceramic tiles any plasterboard may be used if the ceramic tiles are minimum 5mm thick
- > If clearance to glass or stainless steel splashback is 200mm\* or more then any plasterboard may be used
- > If clearance to glass splashback is less than 200mm\* then 10mm plasterboard may be used if the glass is marked as 'toughened safety glass'
- > Clearance to stainless steel splashback is less than 200mm\* then 6mm fibre cement over 10mm plasterboard may be used if the steel is at least 0.4mm thick.

\*Clearance is measured from the edge of the nearest burner to the splashback.



# Installation





### **3.1 CEILINGS** **29**

GENERAL REQUIREMENTS	29
FRAMING	30
PLASTERBOARD LAYOUT	34
PLASTERBOARD FIXING	34
GARAGE CEILINGS	41
EXTERNAL CEILINGS	43

### **3.2 WALLS** **48**

GENERAL REQUIREMENTS	48
FRAMING	48
PLASTERBOARD LAYOUT	49
PLASTERBOARD FIXING	49

### **3.3 WET AREAS** **56**


WET AREAS USING PLASTERBOARD	56
DEFINITIONS	56
WET AREA REQUIREMENTS	57
WATERPROOFING SYSTEMS	58
GENERAL REQUIREMENTS	60
FRAMING	60
PLASTERBOARD FIXING	60



# 3.1 Ceilings

## General Requirements

Install control joints in internal plasterboard ceilings: <ul style="list-style-type: none"><li>&gt; At 12m maximum intervals</li><li>&gt; At all movement joints in the structure</li><li>&gt; At any change in the substrate</li><li>&gt; At the junction of a larger room and passageway.</li></ul>
All ceilings in this section are non-trafficable. Do not walk on plasterboard ceilings!
Limit dead loads on plasterboard ceilings to 2 kg/m <sup>2</sup> for plasterboard spanning 600mm framing centres.
Limit dead loads on plasterboard ceilings to 2.5 kg/m <sup>2</sup> for plasterboard spanning 450mm framing centres where the plasterboard can usually span 600mm centres.
Attach ceiling fixtures to framing members only. Ensure the framing is designed to carry any additional load.

-  > Compensate for uneven framing by attaching a furring channel system with adjustable direct fix clips.
- > Timber trusses may settle or move with changing seasons. Reduce occurrence of plasterboard cracking due to this movement by fixing plasterboard to furring channel or battens.
- > Consider the corrosive effect of sea spray on steel components, select framing and fasteners accordingly.
- > Plasterboard installations in close proximity to metal roofs (ie: raked ceiling or with small ceiling cavities) require smaller control joint intervals as they are exposed to larger rates of thermal expansion.
- > Excessive vibration of the ceiling (by installing ceiling services, etc) is known to cause joint cracking and joint peaking.



## Framing

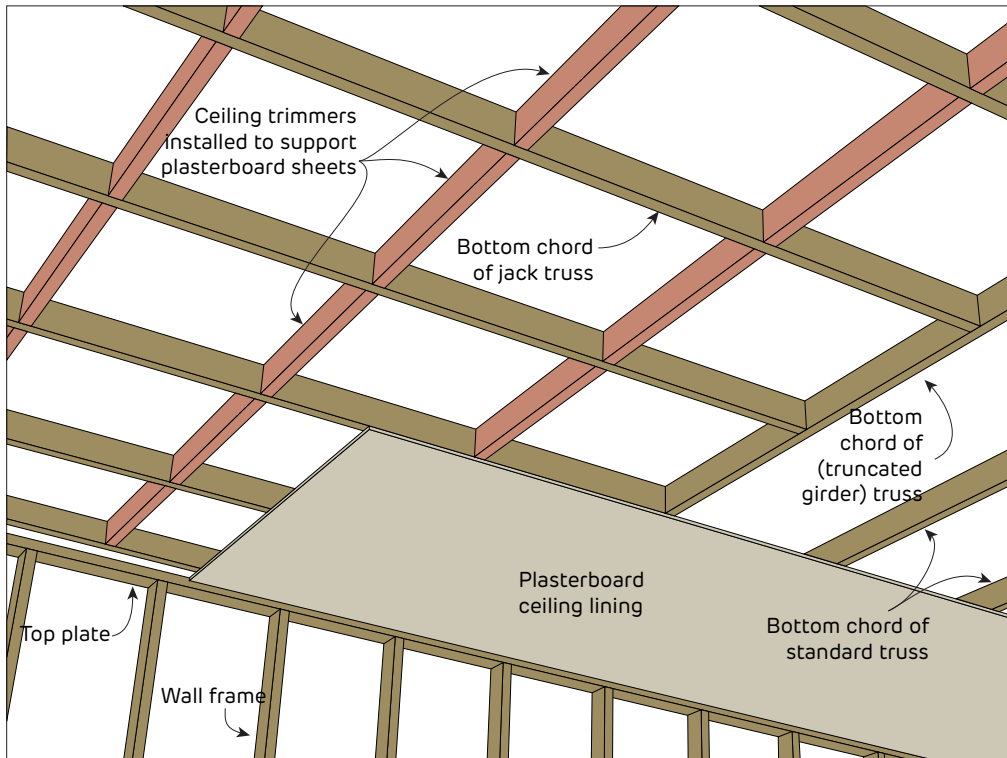
Framing members as per framing table or structural design up to 600mm maximum.
For a specific project, determine the relevant wind pressure load on an internal ceiling from the link or the QR code below. Wind pressure loads must be considered for internal ceilings to comply with <i>AS 4055 Wind loads for housing</i> .
Install additional framing members around openings.

### Siniat Internal Wind Load Calculator

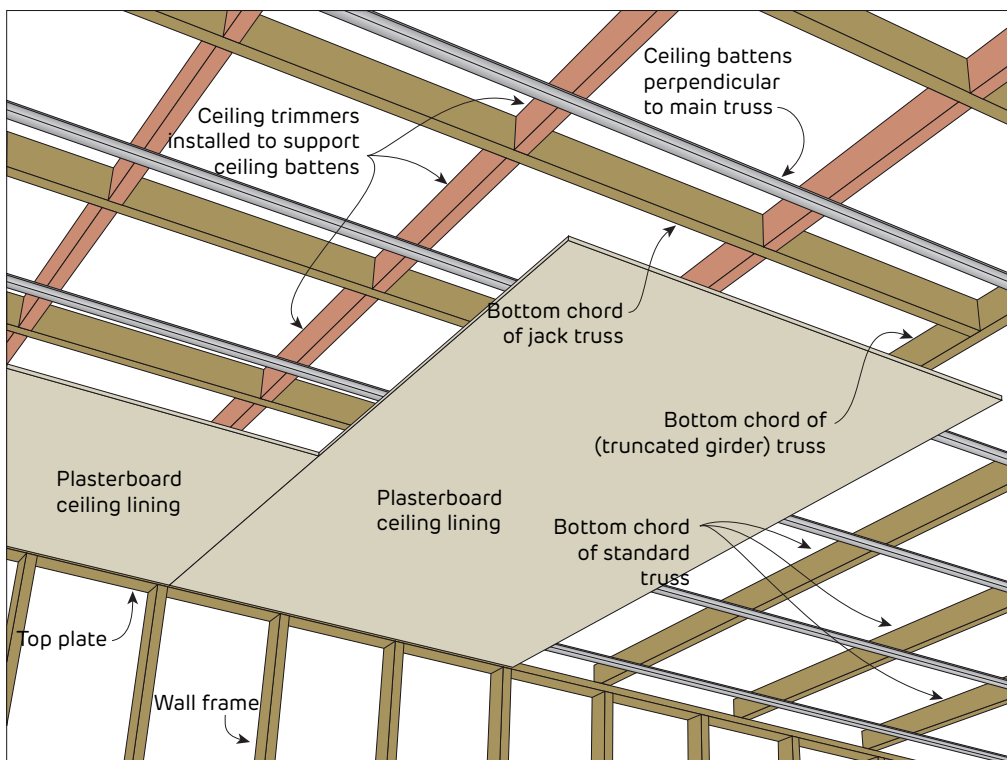


**Table 11 Maximum Span (Frame Spacing) for Plasterboard Ceilings**

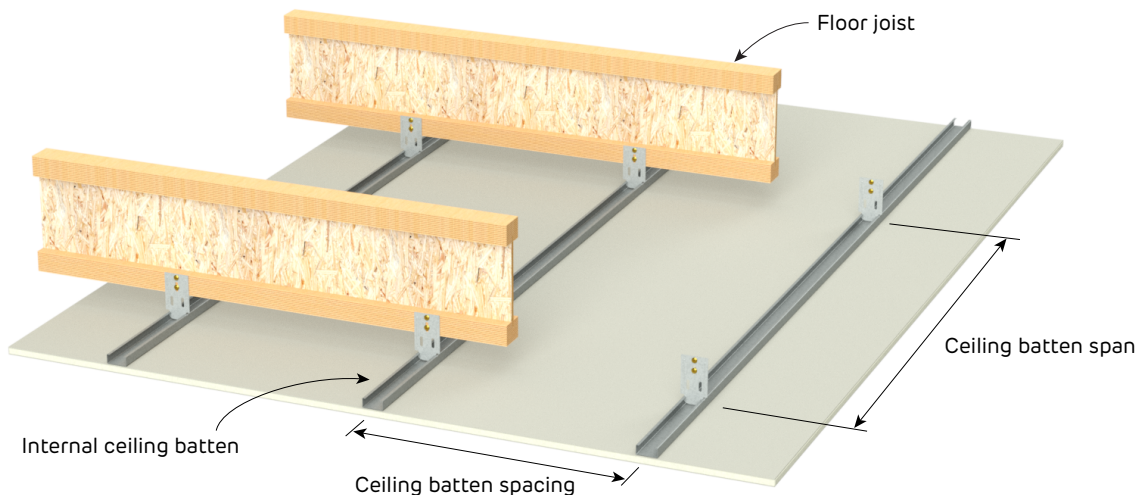
Plasterboard	General Internal Areas	Areas of Intermittent High Humidity eg. Unventilated Bathrooms, Basements and External Ceilings
10mm <b>mastashield</b>	450mm	-
13mm <b>mastashield</b>	600mm	450mm
10mm <b>spanshield</b>	600mm	450mm
10mm <b>opal</b>	600mm	450mm
10mm and 13mm <b>soundshield</b>	600mm	450mm
10mm and 13mm <b>watershield</b>	600mm	450mm



**FIGURE 2** Trimmers to Support Ceiling Lining at Change of Truss Direction  
Perspective



**FIGURE 3** Trimmers to Support Ceiling Battens at Change of Truss Direction  
Perspective



**FIGURE 4 Internal Ceiling Batten Span and Spacing**

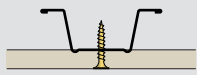
**Table 12 16mm Domestic Batten Internal Ceiling Span Table**

16mm Domestic Batten (AFCDB) Suitable for all 10mm Siniat plasterboard and 13mm Mastashield only					
Wind Zone	Batten Spacing (mm)	Single Span		2-or-more Spans	
		Maximum Span (mm)	Connection Demand (kN)	Maximum Spans (mm)	Connection Demand (kN)
N1	600	740	0.08	920	0.24
	450	820	0.07	1010	0.20
N2	600	740	0.10	920	0.30
	450	820	0.08	1010	0.25
N3	600	740	0.13	810	0.36
	450	820	0.11	940	0.31
N4	600	680	0.17	690	0.42
	450	750	0.14	800	0.37
N5	600	600	0.20	590	0.50
	450	680	0.17	680	0.43
N6	600	520	0.23	520	0.57
	450	600	0.20	600	0.50

1. This table is suitable for internal ceiling use only and includes positive (uplift) and negative (suction) wind pressures using the internal pressure coefficient ( $C_{pi}$ ) as nominated by AS 4055-2012 *Wind loads for housing*.
2. Table includes the steel battens self weight with 1 layer of ceiling lining up to 9 kg/m<sup>2</sup> and also ceiling insulation with a maximum weight of 2.5 kg/m<sup>2</sup>. Table is not applicable to additional point loads and live loads.
3. Table refers to Siniat 16mm Domestic Batten of Base Metal Thickness (BMT) 0.38mm of grade G550 steel with Zincolume™ AM150 corrosion protection.
4. Calculations based upon a single span or 2-or-more spans and designed in accordance with AS/NZS 4600:2018 *Cold Formed Steel Structures*.
5. Ultimate Load Case 1: 1.2G + Wu (suction). Ultimate Load Case 2: 0.9G + Wu (uplift).
6. Serviceability Load Case 1: G, with deflection limited to Span/500. Serviceability Load Case 2: G+W<sub>s</sub>, with deflection limited to Span/200.
7. Connections to ceiling substrate must have a minimum 0.57 kN pull-out capacity. Siniat clips CDB26-80 and CDB26-150 meet this demand.



**Table 13 22mm Cyclonic Batten Internal Ceiling Span Table**


22mm Cyclonic Batten (AFCCB22) Suitable for all 10mm Siniat plasterboard and 13mm Mastashield only					
Wind Zone	Batten Spacing (mm)	Single Span		2-or-more Spans	
		Maximum Span (mm)	Connection Demand (kN)	Maximum Spans (mm)	Connection Demand (kN)
<b>N1</b>	600	1140	0.12	1420	0.38
	450	1260	0.10	1560	0.31
<b>N2</b>	600	1140	0.15	1420	0.46
	450	1260	0.12	1560	0.38
<b>N3</b>	600	1140	0.20	1390	0.62
	450	1260	0.17	1560	0.52
<b>N4</b>	600	1050	0.26	1190	0.73
	450	1150	0.21	1370	0.63
<b>N5</b>	600	950	0.32	1000	0.85
	450	1050	0.27	1160	0.74
<b>N6</b>	600	880	0.39	880	0.97
	450	970	0.32	1020	0.85
<b>C1</b>	600	1000	0.34	1010	0.85
	450	1200	0.30	1170	0.74
<b>C2</b>	600	850	0.41	850	1.02
	450	1000	0.36	980	0.88
	400	1040	0.33	1040	0.83
	300	1200	0.29	1200	0.72
<b>C3</b>	600	700	0.48	710	1.22
	450	820	0.42	820	1.05
	400	900	0.41	870	0.99
	300	1000	0.34	1000	0.86
<b>C4</b>	600	620	0.56	610	1.38
	450	700	0.48	710	1.21
	400	760	0.46	750	1.13
	300	900	0.41	870	0.99

1. This table is suitable for internal ceiling use only and includes positive (uplift) and negative (suction) wind pressures using the internal pressure coefficient ( $C_{pi}$ ) as nominated by *AS 4055-2012 Wind loads for housing*.
2. Table includes the steel battens self weight with 1 layer of ceiling lining up to 9 kg/m<sup>2</sup> and also ceiling insulation with a maximum weight of 2.5 kg/m<sup>2</sup>. Table is not applicable to additional point loads and live loads.
3. Table refers to Siniat 16mm Domestic Batten of Base Metal Thickness (BMT) 0.38mm of grade G550 steel with Zinalume™ AM150 corrosion protection.
4. Calculations based upon a single span or 2-or-more spans and designed in accordance with *AS/NZS 4600:2018 Cold Formed Steel Structures*.
5. Ultimate Load Case 1: 1.2G + Wu (suction). Ultimate Load Case 2: 0.9G + Wu (uplift).
6. Serviceability Load Case 1: G, with deflection limited to Span/500. Serviceability Load Case 2: G+W<sub>s</sub>, with deflection limited to Span/200.
7. Connections to ceiling substrate must have a minimum Ultimate Limit State pull-out design capacity of 0.75kN per screw. Minimum 2 screws per connection. 6g x 25mm screws into timber provide 0.75 kN capacity according to AS 1720.1 with minimum 17mm embedment depth.



## Plasterboard Layout


Sheet ceilings perpendicular to framing members.
Stagger face layer butt joints by 600mm minimum on adjoining sheets and between layers.
Stagger recessed edges by 300mm minimum between layers.
Follow the back-blocking requirements and butt joint placement for the level of finish selected. [Refer To Section 4.2]

 > Sheet ceilings parallel to the light source to reduce the effect of glancing light.

- > Minimise butt joints by using the longest sheet possible.
- > Butt joints on underlying layers (not face layer) may be made on the same framing member.
- > For 2 layer systems at 450mm centres, face layer butt joints may be fixed to framing members.

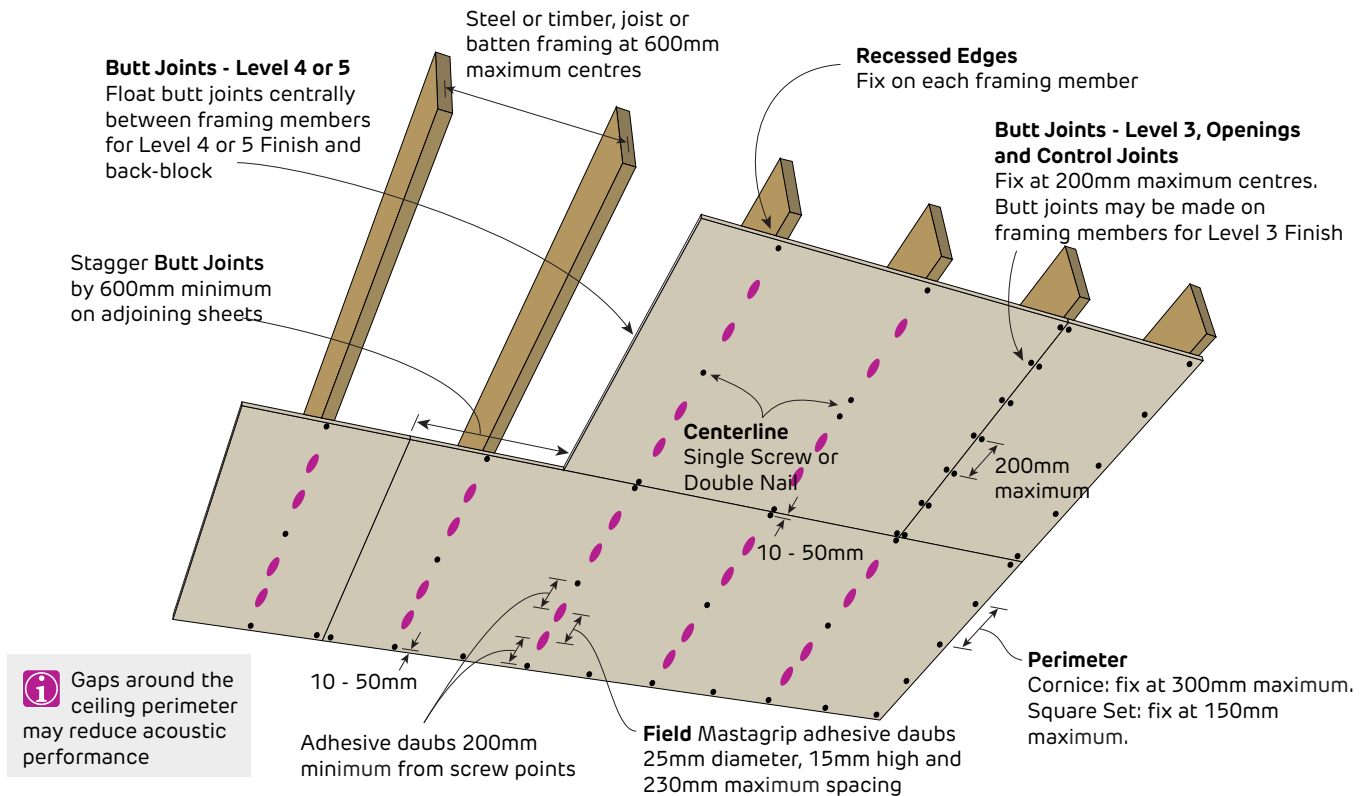
## Plasterboard Fixing

Drive screws to just below the sheet surface, taking care not to break the paper linerboard. For over-driven screws, install another screw 20mm away. Leave or remove the over-driven screw and patch.
Use laminating screws to fix floating butt joints in the second and third layer.
<b>Fastener and Adhesive Method</b>
Apply <b>mastagrip</b> Stud Adhesive after the frame is clean, dry, and free from grease, dust and other contaminants.
Apply <b>mastagrip</b> daubs 200mm minimum from screws and plasterboard edges.
<b>One Third Fastener and Adhesive Method</b>
Use the 'One Third Fastener and Adhesive Method' for garage ceilings or as an alternative method in general areas.
<b>Fastener Only Method</b>
Use the 'Fastener Only Method' for external ceilings or as an alternative method for general areas and garage ceilings.

 The 'Screw and Adhesive Method' is recommended for non-fire rated applications. **mastagrip** will:

- > Minimise screw popping
- > Reduce the number of screw heads that may show in glancing light
- > Assist in compensating for frame irregularities.

**FIGURE 5 Internal Ceiling - 1 Layer**  
 Fastener and Adhesive Method



### Fixing Pattern Table

Sheet Width	Fixing Pattern
600mm	F F F F
900mm	F A F/F A F
1200mm	F A A F/F A A F
1350mm	F A A F/F A A F

F = One screw or nail

F/F = One screw or double nails

A = One adhesive daub

Note: On 1350mm wide sheets use temporary fasteners until adhesive sets.

### Maximum Wind Class Table

Plasterboard	Maximum Ceiling Frame Spacing		
	600mm	450mm	300mm
10mm <b>mastashield</b>	-	N5 / C1	N6 / C2
10mm <b>spanshield</b>	N4	N5 / C1	N6 / C2
10mm <b>watershield</b>			
10mm <b>soundshield</b>			
10mm <b>opal</b>			
13mm <b>mastashield</b>			

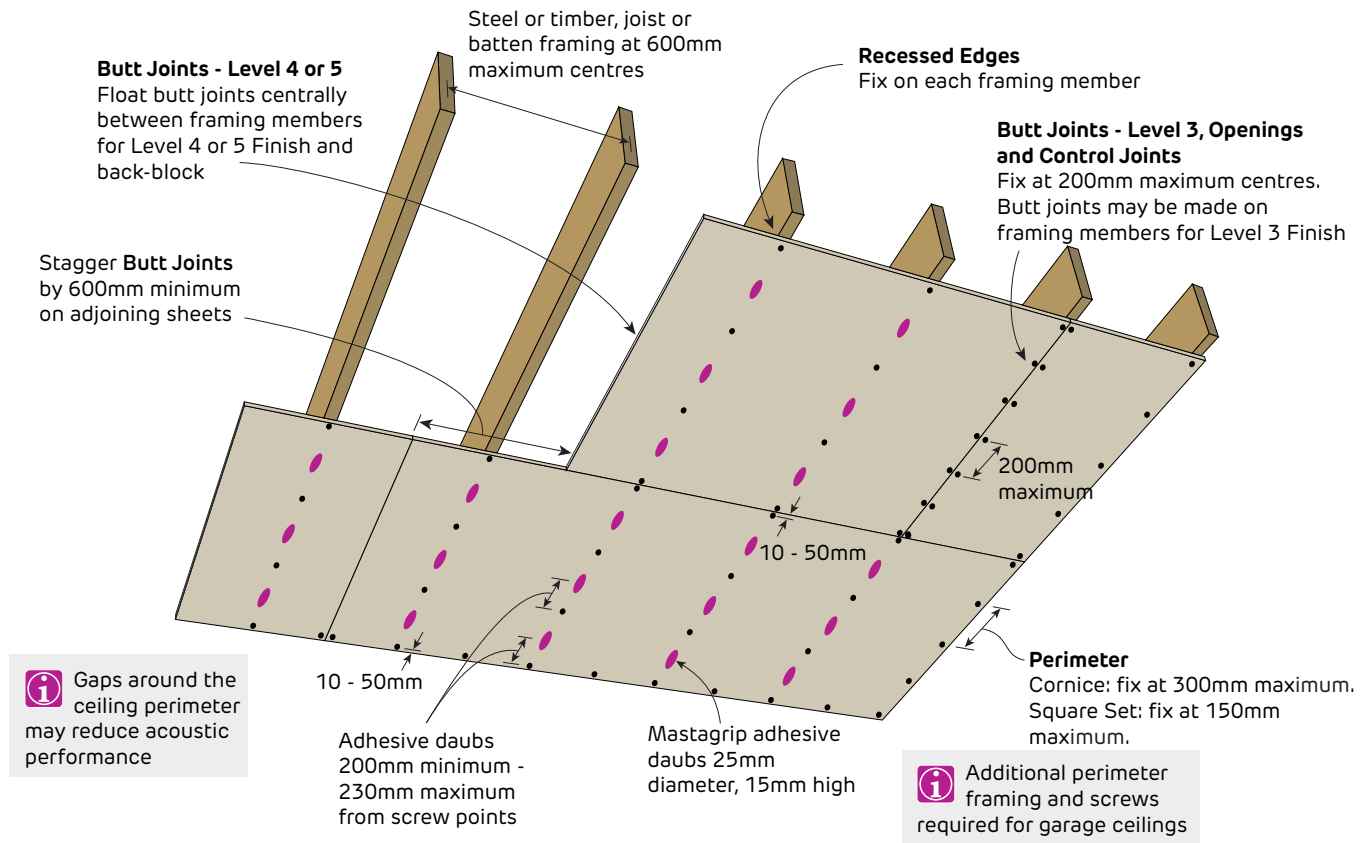
1. Wind loads in accordance with AS 4055 *Wind loads for housing*.

2. Calculations do not include the framing which must be independently designed to suit the desired wind zone.

3. Calculations include a ceiling insulation with maximum weight of 2.5 kg/m<sup>2</sup> (equivalent to R5.0 Pink® Batts Ceiling insulation).



**FIGURE 6 Internal Ceiling - 1 Layer**  
One Third Fastener and Adhesive Method



**Fixing Pattern Table**

Sheet Width	Fixing Pattern
600mm	F F F F
900mm	F A F A F
1200mm	F A F A F A F
1350mm	F A F A F A F

F = One screw

A = One adhesive daub

Note: On 1350mm wide sheets use temporary fasteners until adhesive sets.

**Maximum Wind Class Table**

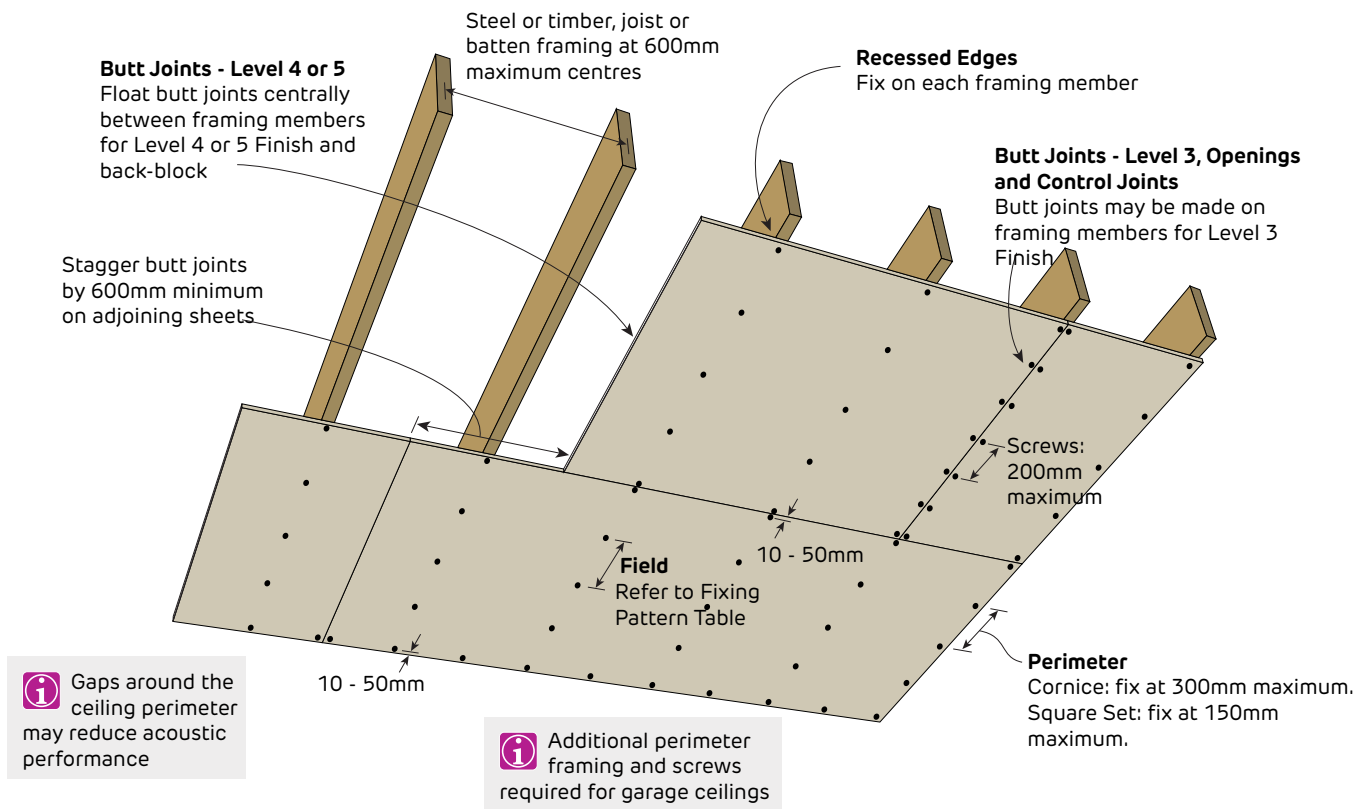
Plasterboard	Maximum Ceiling Frame Spacing		
	600mm	450mm	300mm
10mm mastashield	-	N5 / C1	N6 / C2
10mm spanshield	N4	N5 / C1	N6 / C2
10mm watershield			
10mm soundshield			
10mm opal			
13mm mastashield			

1. Wind loads in accordance with AS 4055 Wind loads for housing.

2. Calculations do not include the framing which must be independently designed to suit the desired wind zone.

3. Calculations include a ceiling insulation with maximum weight of 2.5 kg/m<sup>2</sup> (equivalent to R5.0 Pink® Batts Ceiling insulation).

**FIGURE 7 Internal Ceiling - 1 Layer**  
**Fastener Only Method**



### Fixing Pattern Table

Sheet Width	Screw Fixing Pattern	Nail Fixing Pattern
600mm	S S S (3)	N N N N N (5)
900mm	S S S S (4)	N N N N N N (6)
1200mm	S S S S S (5)	N N N N N N N (7)
1350mm	S S S S S S (6)	N N N N N N N N (8)

S = One screw

N = One nail

Dn = Double nail

### Maximum Wind Class Table

Plasterboard	Maximum Ceiling Frame Spacing		
	600mm	450mm	300mm
10mm <b>mastashield</b>	-	N5 / C1	N6 / C2
10mm <b>spanshield</b>	N4	N5 / C1	N6 / C2
10mm <b>watershield</b>			
10mm <b>soundshield</b>			
10mm <b>opal</b>			
13mm <b>mastashield</b>			

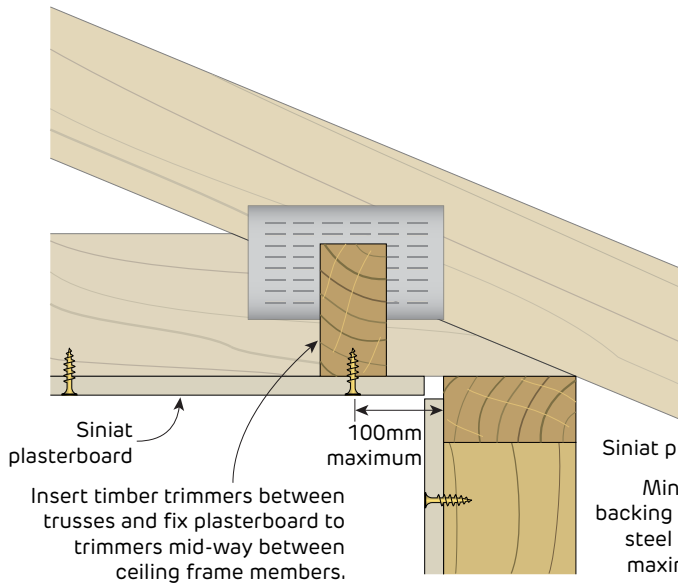
1. Wind loads in accordance with AS 4055 *Wind loads for housing*.

2. Calculations do not include the framing which must be independently designed to suit the desired wind zone.

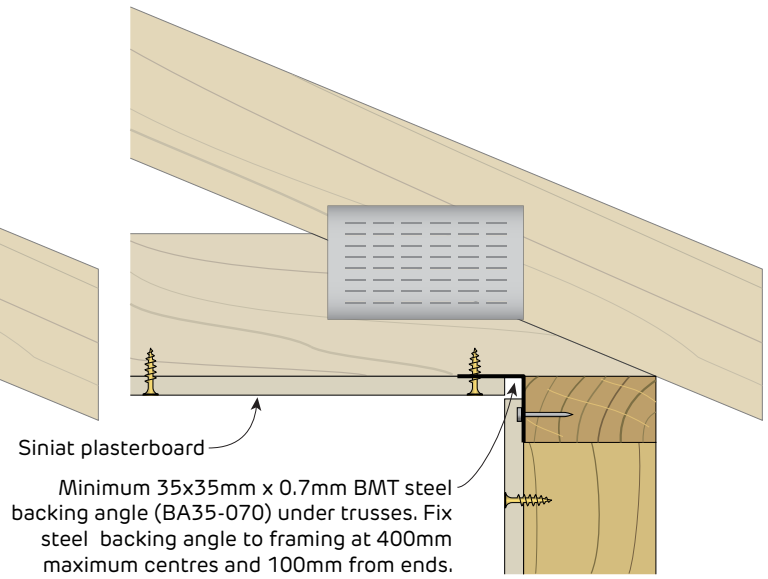
3. Calculations include a ceiling insulation with maximum weight of 2.5 kg/m<sup>2</sup> (equivalent to R5.0 Pink® Batts Ceiling insulation).



### Internal Ceiling - Perimeter Framing

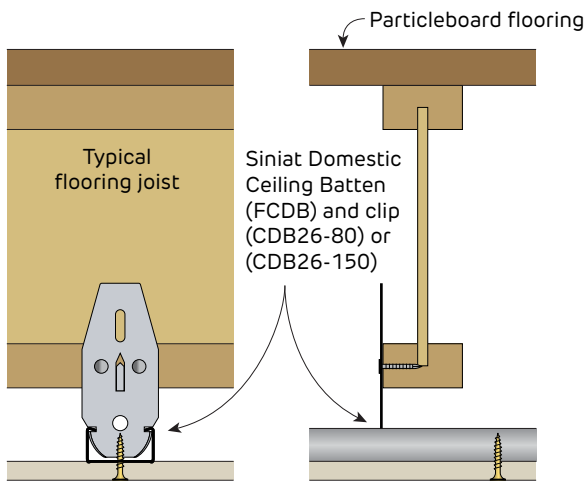


**FIGURE 9** Perimeter Framing for Plasterboard Section



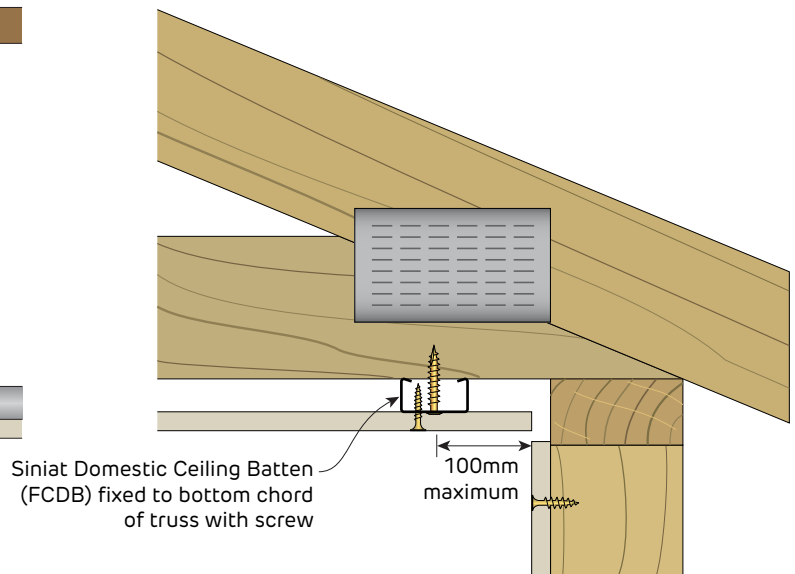
**FIGURE 10** Perimeter Framing for Plasterboard Section

### Internal Ceiling - 16mm Domestic Ceiling Batten



Suspended ceiling systems like battens installed with clips under floors and/or roofs, do not provide sufficient diaphragm action to transfer wind loads to bracing walls. As such, the house frame designer must be consulted for an alternative method to transfer these loads.

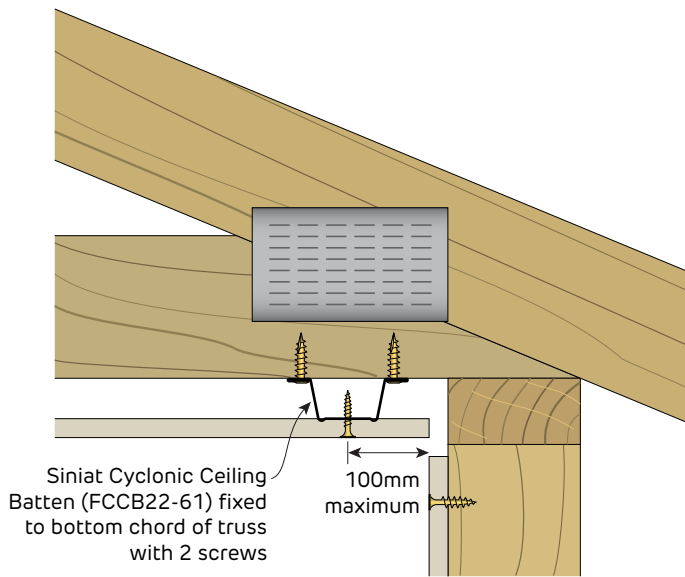
**FIGURE 11** Direct Fix Ceiling to Floor Joist  
16mm Domestic Batten and Clip Sections



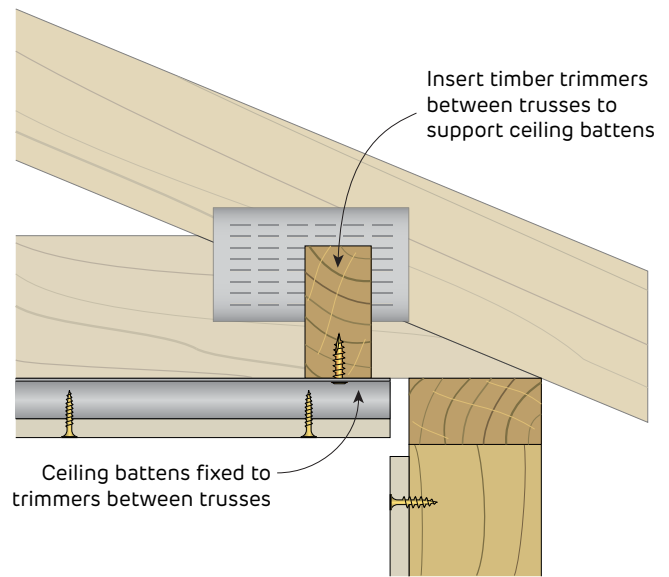
**FIGURE 12** Direct Fix Ceiling to Roof Truss  
16mm Domestic Batten fixed directly to trusses Section



Internal Ceiling - 22mm Cyclonic Ceiling Batten

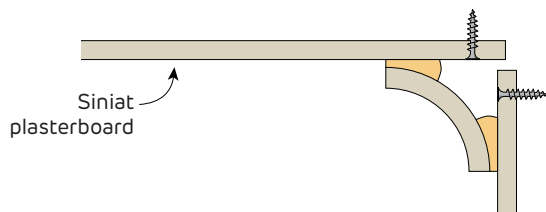


**FIGURE 13 Direct Fix Ceiling to Roof Truss**  
22mm Cyclonic Batten perpendicular to trusses  
Section

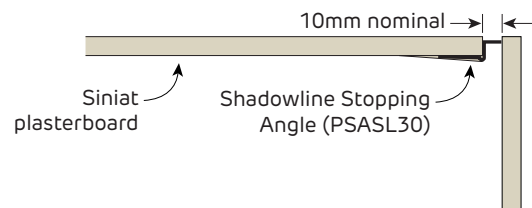


**FIGURE 14 Direct Fix Ceiling to Roof Truss**  
22mm Cyclonic Batten parallel to trusses  
Section

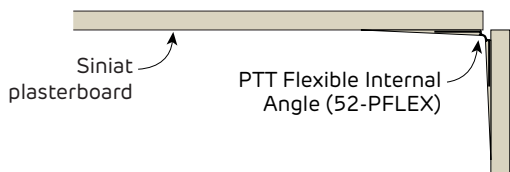
Ceiling Perimeter Finishing Details



**FIGURE 15 Finishing Detail - Cornice**  
Section



**FIGURE 16 Finishing Detail - Shadowline**  
Section



**FIGURE 17 Finishing Detail - Flexible Square Set**  
Section



## Garage Ceilings

Garage ceilings are subject to conditions that are more demanding than in other parts of the home. This is the case even when garages are located under the same roof as the rest of the home. Garages have large doors that when open let in rain and strong wind. Cars are garaged wet and they are not normally heated spaces. These factors call for a more durable installation to avoid future maintenance issues.

### Installation Requirements for Garage Ceilings

- > The plasterboard framing must be designed for the appropriate wind loading conditions
- > Fix the ceiling sheets using the 'Screw Only Method' or the 'One Third Fixing Method' [Refer to 3.1 Ceilings]

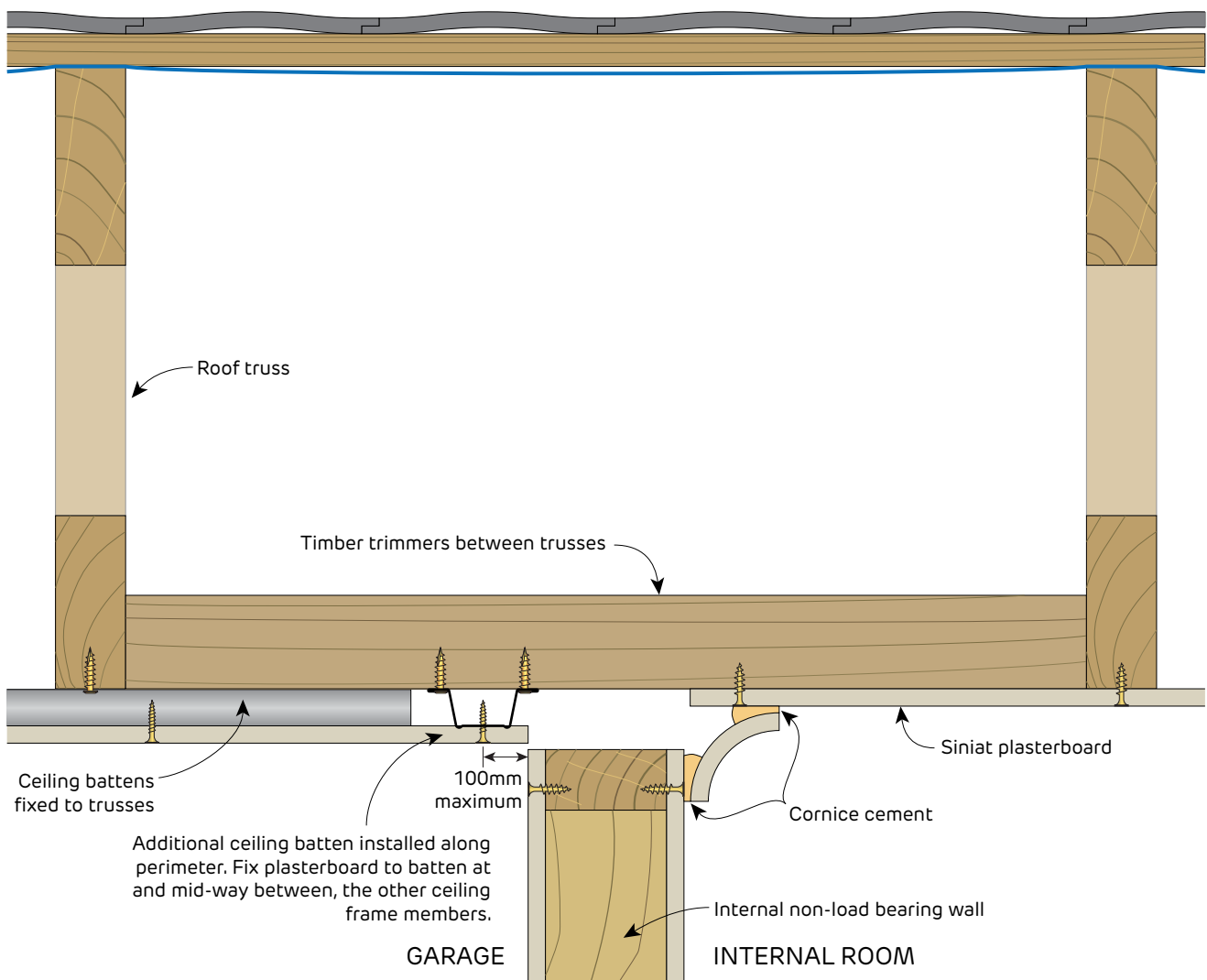
- > Provide additional framing around perimeter by inserting trimmers between ceiling frames or installing Siniat steel angle [Refer to Figures 21 and 22]
- > Fix the perimeter of the sheets using screws at 300mm maximum spacing
- > Avoid windy conditions during and immediately after installation to ensure adhesive sets intact
- > Back-block all plasterboard joints [Refer to Section 4.2 Back-Blocking]
- > Roll or brush on a high quality sealer undercoat



Recommendations:

- > Ventilate the roof cavity, in particular skillion roofs [Refer to Condensation and Ventilation]
- > Roll or brush on a high quality three coat paint system

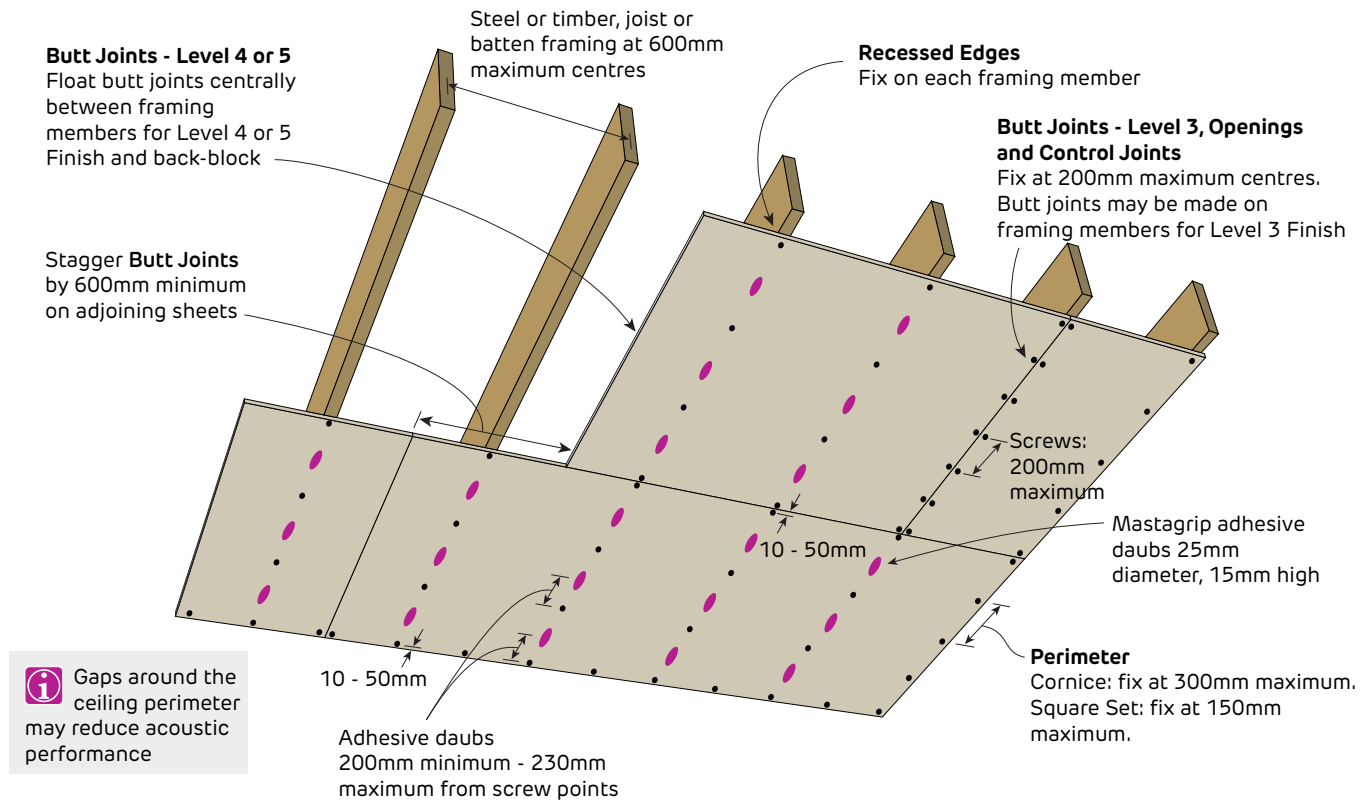
### Garage Ceiling to Internal Room Ceiling



**FIGURE 18** Plasterboard Ceiling Perimeter Detail  
 Cornice Only



**FIGURE 19 Internal Garage Ceiling - 1 Layer**  
One Third Fastener and Adhesive Method



**Fixing Pattern Table**

Sheet Width	Fixing Pattern
600mm	F F F F
900mm	F A F A F
1200mm	F A F A F A F
1350mm	F A F A F A F

F = One screw

A = One adhesive daub

Note: On 1350mm wide sheets use temporary fasteners until adhesive sets.

**Maximum Wind Class Table**

Plasterboard	Maximum Ceiling Frame Spacing		
	600mm	450mm	300mm
10mm mastashield	-	N5 / C1	N6 / C2
10mm spanshield	N4	N5 / C1	N6 / C2
10mm watershield			
10mm soundshield			
10mm opal			
13mm mastashield			

1. Wind loads in accordance with AS 4055 Wind loads for housing.

2. Calculations do not include the framing which must be independently designed to suit the desired wind zone.

3. Calculations include a ceiling insulation with maximum weight of 2.5 kg/m<sup>2</sup> (equivalent to R5.0 Pink® Batts Ceiling insulation).



## External Ceilings

External ceilings include alfresco areas, carports, balconies, breezeways and foyers with plasterboard installed horizontally or sloping away from the main dwelling. External ceilings are subjected to harsher conditions than internal ceilings, and therefore they need additional protection from the weather. This extra protection is designed to control the major causes of external ceiling faults which are:

- > Condensation on the plasterboard, ceiling framing, roof framing or roof lining and dripping down onto the ceiling
- > Water penetrating the paint system
- > Distortion of plasterboard joints
- > Plasterboard sagging
- > Mould growth
- > Fastener popping
- > Corrosion of ceiling framing.

### Minimum Conditions to Use Plasterboard and Steel Ceiling Framing in External Ceilings

- > The plasterboard and associated substrate must be designed for the appropriate loading conditions including wind loads. Down-struts must also be included for suspended ceilings to prevent uplift.
- > The plasterboard and steel framing must be suitable for the application [Refer to 'Plasterboard' and 'Steel Framing' in Section 2.1]
- > The cavity above the plasterboard ceiling must have adequate ventilation [Refer to 'Condensation and Ventilation' in Section 2.2]. Please note, continuous air-flow in and out of a ceiling cavity near salt water may decrease the durability of steel framing.
- > Condensation on the back and front of the plasterboard lining and any steel framing must be controlled. Use condensation prevention measures such as, adequate roof cavity ventilation and thermal insulation. In particular, foil backed insulation must be used under a metal roof.
- > Anchors and fasteners used must be minimum Class 3 or higher depending on the application, or protected from corrosion by other means. Note that stainless steel fasteners are not permitted with galvanised or Zinalume protected steels.
- > The plasterboard, compounds and steel framing must not be subjected to any direct water, long periods of high humidity, sea spray or damp conditions.

- > The plasterboard and compounds must be installed after the roof covering has been completely installed and sealed.
- > Minimum 100mm clearance from external ceiling lining to lower edge of verandah beam or masonry lintel, otherwise provide protection against wind blown rain.
- > Periodic inspections of any steel ceiling framing must be conducted to identify any areas of corrosion or damage which must be immediately rectified.

### Installation Requirements for External Ceilings

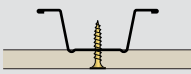
- > Use either 10mm **spanshield**, 13mm **mastashield**, 10mm **opal**, 10mm or 13mm **watershield**, 10mm or 13mm **soundshield**, 13mm or 16mm **fireshield**, **multishield** or **trurock**.
- > Ceiling framing at maximum 450mm framing centres [Refer to Figure 20].
- > Provide additional framing around the perimeter by inserting trimmers between ceiling frames or installing steel angle, or installing additional ceiling battens.
- > Fix the ceiling plasterboard using the 'Screw Only Method'. Nails are not permitted in this application. Additional screws may be required for high wind areas.
- > Fix the perimeter of the plasterboard sheets using screws at 300mm maximum spacing.
- > Install control joints at 6m maximum intervals.
- > Back-block all plasterboard joints. [Refer to Section 4.2]
- > Plaster set joints using two coats of **mastabase** or **mastalongset** and any Siniat finish coat.
- > Roll or brush on a high quality sealer undercoat designed for exterior use.
- > Use a premium exterior paint system that includes a mould inhibitor.

Please note that plasterboard must not be installed in eaves or as exterior cladding.



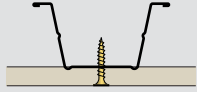
Thermal insulation is recommended directly above the plasterboard. This will minimise the temperature difference between the plasterboard and outside air, limiting ceiling sag and mould formation by reducing condensation on the plasterboard.


**Table 14 22mm Cyclonic Batten External Ceiling Span Table**

22mm Cyclonic Batten (AFCCB22) Suitable for 1 layer of ceiling lining up to 12.5 kg/m <sup>2</sup>					
Wind Zone	Batten Spacing (mm)	Single Span		2-or-more Spans	
		Maximum Span (mm)	Connection Demand (kN)	Maximum Spans (mm)	Connection Demand (kN)
N1	450	950	0.23	1180	0.72
	400	990	0.22	1230	0.67
	300	1090	0.18	1350	0.55
N2	450	950	0.31	1030	0.83
	400	990	0.29	1090	0.78
	300	1090	0.24	1260	0.68
N3 / C1	450	850	0.41	840	1.01
	400	890	0.38	890	0.95
	300	980	0.31	1030	0.83
N4 / C2	450	700	0.49	700	1.22
	400	750	0.46	740	1.14
	300	870	0.40	860	1.00
N5 / C3	450	600	0.60	580	1.45
	400	620	0.55	620	1.38
	300	720	0.48	710	1.19
N6 / C4	450	500	0.67	500	1.68
	400	540	0.64	530	1.58
	300	620	0.55	620	1.39

1. This table is suitable for covered external ceiling use and includes positive (uplift) and negative (suction) wind pressures as nominated by AS 4055-2012 *Wind loads for housing*.
2. Table includes the steel battens self weight with 1 layer of ceiling lining up to 12.5 kg/m<sup>2</sup> and also ceiling insulation with a maximum weight of 2.5 kg/m<sup>2</sup>.
3. Table is not applicable to additional point loads and live loads.
4. Table refers to Siniat 22mm Cyclonic Batten of Base Metal Thickness (BMT) 0.42mm of grade G550 steel with Zinalume™ AM150 corrosion protection.
5. Calculations based upon a single span or 2-or-more spans and designed in accordance with AS/NZS 4600:2018 *Cold Formed Steel Structures*.
6. Ultimate Load Case 1: 1.2G + Wu (suction). Ultimate Load Case 2: 0.9G + Wu (uplift).
7. Serviceability Load Case 1: G, with deflection limited to Span/500. Serviceability Load Case 2: G+W<sub>s</sub>, with deflection limited to Span/200.

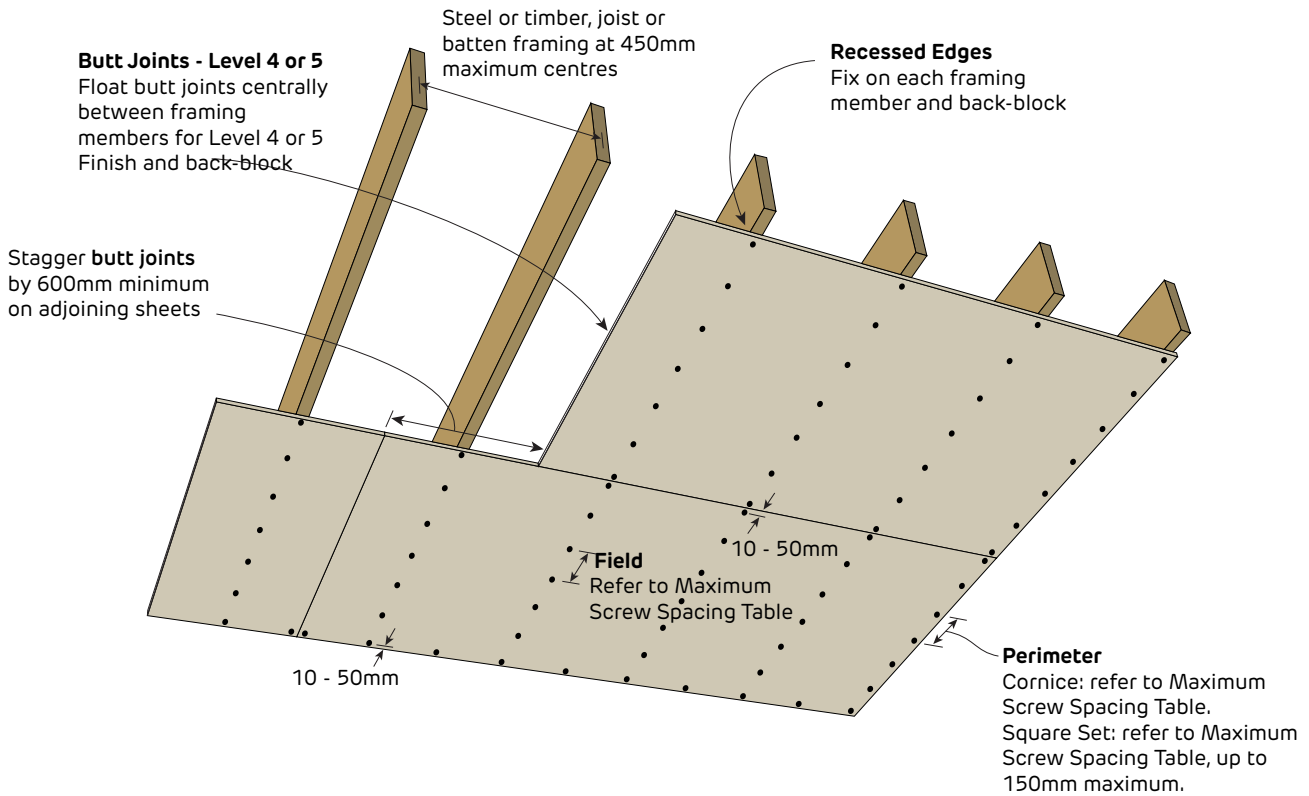
**Table 15 35mm Batten External Ceiling Span Table**

35mm Batten (AFCCB35) Suitable for 1 layer of ceiling lining up to 12.5 kg/m <sup>2</sup>					
Wind Zone	Batten Spacing (mm)	Single Span		2-or-more Spans	
		Maximum Span (mm)	Connection Demand (kN)	Maximum Spans (mm)	Connection Demand (kN)
N1	450	1140	0.28	1430	0.87
	400	1210	0.26	1520	0.82
	300	1400	0.23	1750	0.71
N2	450	990	0.32	1240	1.00
	400	1050	0.30	1320	0.94
	300	1220	0.26	1520	0.81
N3 / C1	450	810	0.39	1020	1.22
	400	860	0.37	1080	1.15
	300	990	0.32	1240	0.99
N4 / C2	450	670	0.46	840	1.45
	400	710	0.44	890	1.37
	300	830	0.38	1030	1.19
N5 / C3	450	560	0.56	700	1.75
	400	590	0.52	740	1.65
	300	690	0.46	860	1.43
N6 / C4	450	480	0.64	590	1.97
	400	510	0.61	640	1.90
	300	590	0.53	740	1.65

1. This table is suitable for covered external ceiling use and includes positive (uplift) and negative (suction) wind pressures as nominated by AS 4055-2012 *Wind loads for housing*.
2. Table includes the steel battens self weight with 1 layer of ceiling lining up to 12.5 kg/m<sup>2</sup> and also ceiling insulation with a maximum weight of 2.5 kg/m<sup>2</sup>.
3. Table is not applicable to additional point loads and live loads.
4. Table refers to Siniat 35mm Batten of Base Metal Thickness (BMT) 0.42mm of grade G550 steel with Zinalume™ AM150 corrosion protection.
5. Calculations based upon a single span or 2-or-more spans and designed in accordance with AS/NZS 4600:2018 *Cold Formed Steel Structures*.
6. Ultimate Load Case 1: 1.2G + Wu (suction). Ultimate Load Case 2: 0.9G + Wu (uplift).
7. Serviceability Load Case 1: G, with deflection limited to Span/500. Serviceability Load Case 2: G+W<sub>s</sub>, with deflection limited to Span/200.



**FIGURE 20 External Ceiling - 1 Layer**  
Screw Only Method



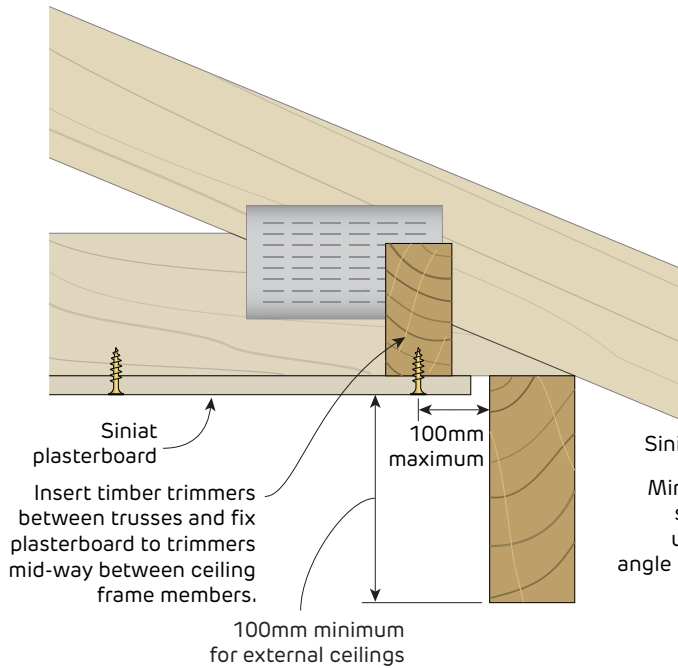
**Maximum Screw Spacing Table For External Ceilings (mm)**

Plasterboard	Wind Zone	Maximum External Ceiling Frame Spacing	
		450mm	300mm
10mm <b>spanshield</b> 10mm <b>watershield</b> 13mm <b>mastashield</b> 13mm <b>watershield</b>	N1	300	300
	N2	250	300
	N3 / C1	150	250
	N4 / C2	100	150
	N5 / C3	-	100
10mm <b>soundshield</b> 10mm <b>opal</b>	N1	300	300
	N2	300	300
	N3 / C1	200	300
	N4 / C2	150	250
	N5 / C3	-	150

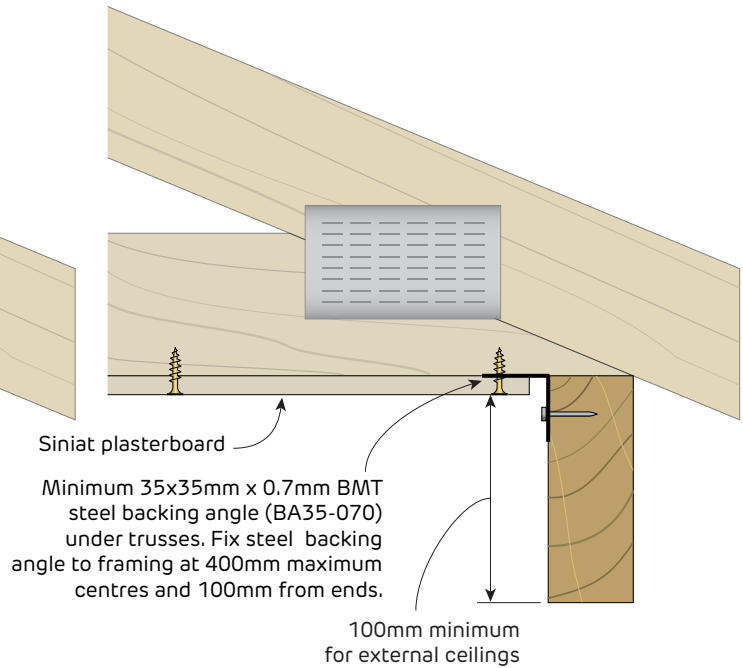
1. Wind loads in accordance with AS 4055 Wind loads for housing.
2. Calculations do not include the framing which must be independently designed to suit the desired wind zone.
3. Calculations include a ceiling insulation with maximum weight of 2.5 kg/m<sup>2</sup> (equivalent to R5.0 Pink® Batts Ceiling insulation).

## Garage Ceiling and External Ceilings

### Plasterboard Ceiling Directly Fixed to Trusses

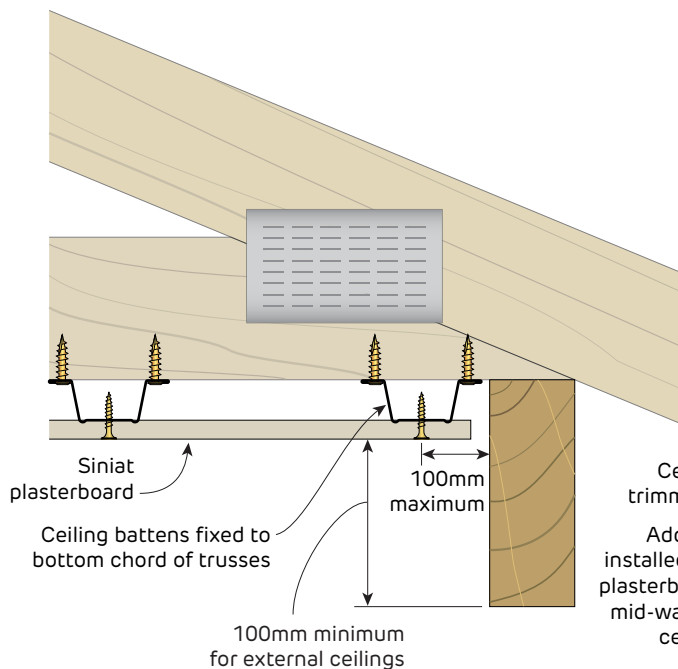


**FIGURE 21 Plasterboard Ceiling Fixed to Roof Truss**  
 With perimeter timber trimmers between trusses  
 Section

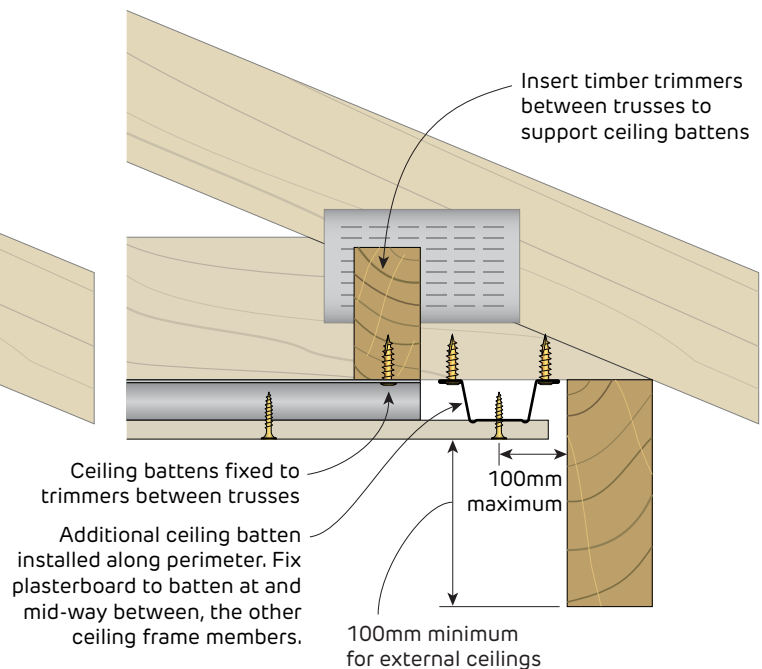


**FIGURE 22 Plasterboard Ceiling Fixed to Roof Truss**  
 Alternative detail with perimeter steel angle  
 Section

### Plasterboard Ceiling Fixed to Battens Under Trusses



**FIGURE 23 Plasterboard Ceiling Fixed to Battens**  
 Ceiling battens installed perpendicular to trusses  
 Section



**FIGURE 24 Plasterboard Ceiling Fixed to Battens**  
 Ceiling battens installed parallel to trusses  
 Section



## 3.2 Walls

### General Requirements

Install control joints in plasterboard walls:

- > At 12m maximum intervals
- > At 4.2m maximum intervals when tiled
- > At all movement joints in the building
- > At any change in the substrate
- > At the floor line in stairways. Cover gap with a moulding fastened to one edge.

Attach all fixtures to studs, noggings/blocking or the masonry wall.

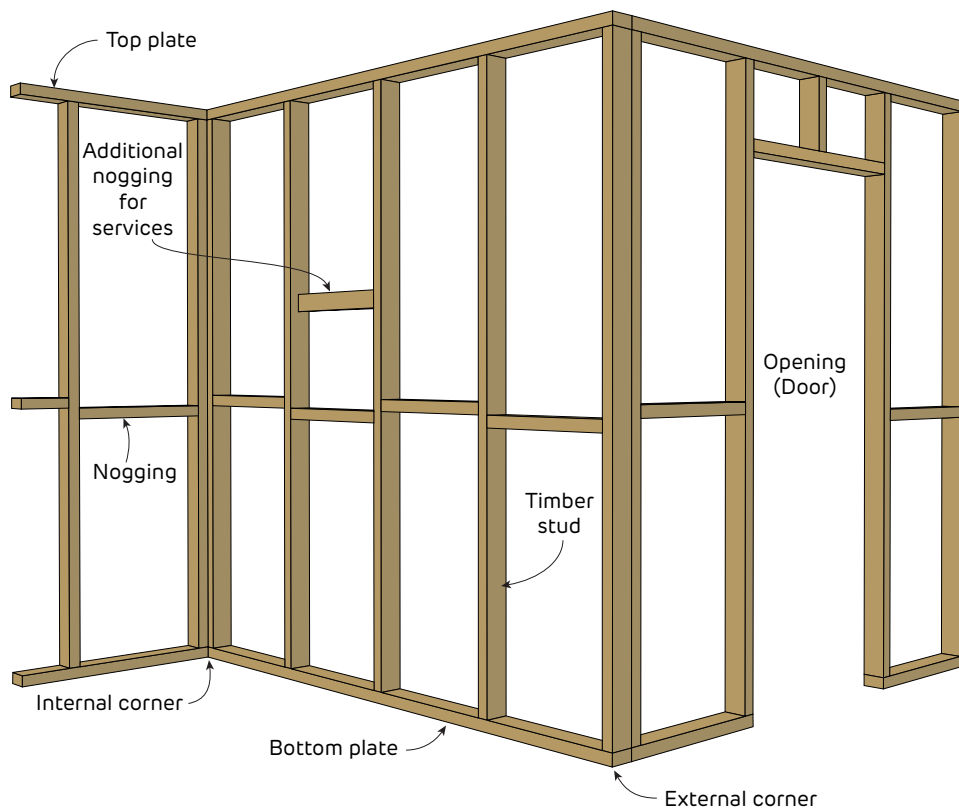


FIGURE 25 Wall Frame Layout

### Framing

Framing members as per structural design up to 600mm maximum.


- i** > Noggings are permitted to assist the fixing of services
- > Plumbing and electrical services must not protrude beyond the face of the stud
- > Copper Chromium Arsenate (CCA) treated timber must not be used with steel frames






## Plasterboard Layout

Vertical joints must be 200mm minimum from the edge of any opening such as windows and doorways to minimise cracking at the joints.
<b>Horizontal Layout</b>
Stagger butt joints by 300mm minimum on adjoining sheets, between layers and on opposite sides of the wall.
First layer butt joints must be backed by a stud or back-blocked.
Stagger recessed edges by 300mm minimum between layers.

-  > Install plasterboard sheets horizontally when practical reduce the effect of glancing light.
- > Minimise butt joints by using long sheets.

## Plasterboard Fixing

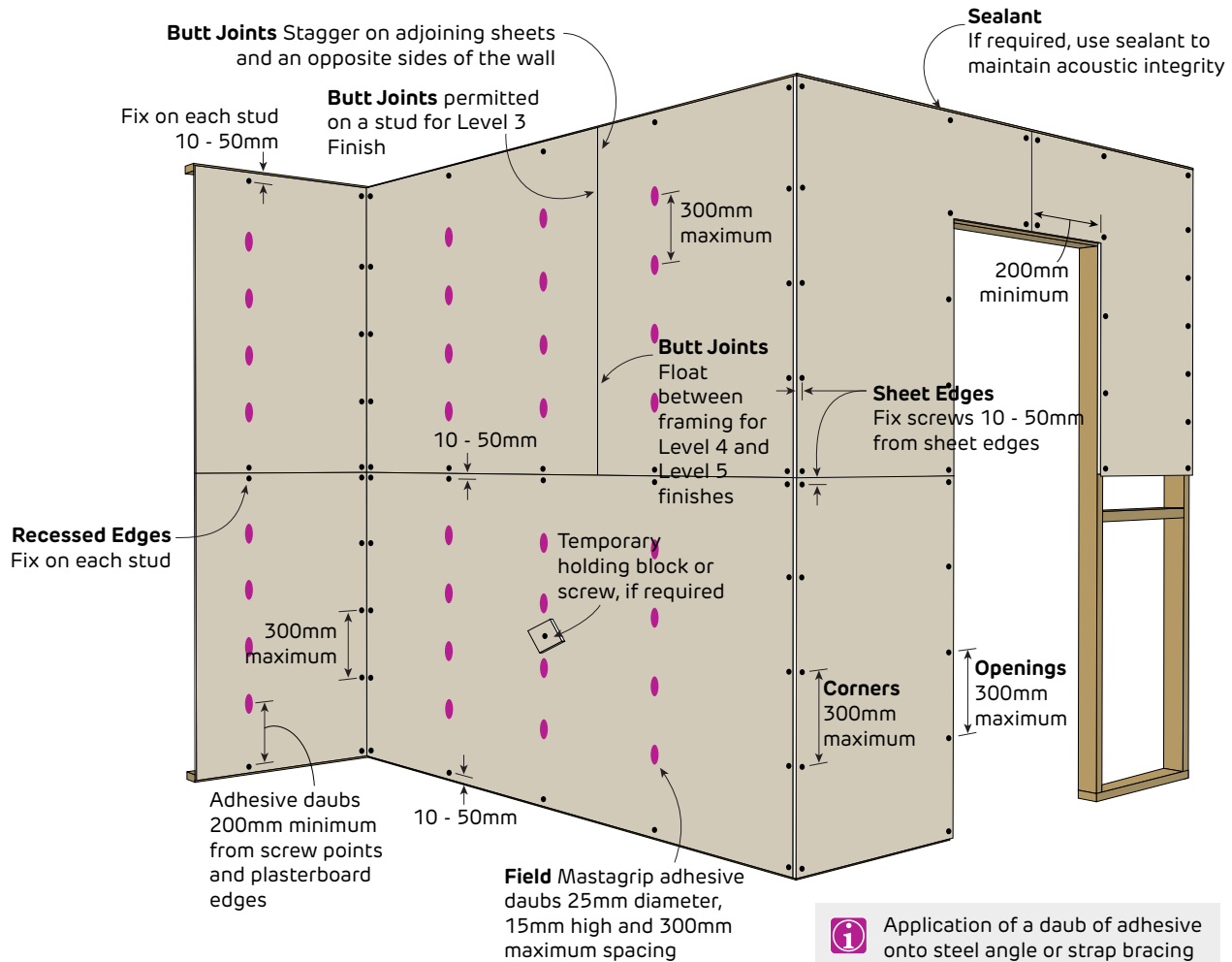
Drive screws to just below the sheet surface, taking care not to break the paper linerboard. For over-driven screws, install another screw 20mm away. Leave or remove the over-driven screw and patch.
Laminating screws can be used to fix butt joints in the second and third layer.
<b>Fastener and Adhesive Method</b>
Apply <b>mastagrip</b> Stud Adhesive after the frame is clean, dry, and free from oil, dust and other contaminants.
Apply <b>mastagrip</b> daubs 200mm minimum from screws and plasterboard edges.
<b>Fastener Only Method</b>
Use the 'Fastener Only Method' in tiled areas or as an alternative to the 'Fastener and Adhesive Method' in general areas.
<b>Masonry Adhesive Method</b>
Apply <b>mastabond</b> Masonry Adhesive over masonry walls ensuring they are clean, dry, and free from oil, dust and other contaminants.

-  The 'Fastener and Adhesive Method' is recommended for non-fire rated applications. **mastagrip** will:
  - > Minimise screw popping
  - > Reduce the number of screw heads that may show in glancing light
  - > Assist in compensating for frame irregularities
  - > Reduce rattle noise when applied to bracing straps.

Where practicable, the centre portion of the sheet should be fixed first then proceeding towards the ends and edges. Alternatively, the sheet can be fastened starting at one edge working across the sheet to the other edge.



**FIGURE 26 Internal Wall - 1 Layer Horizontal**  
Fastener and Adhesive Method



**i** Application of a daub of adhesive onto steel angle or strap bracing between framing members will minimise the risk of the bracing rattling against the back of the gypsum linings.

**Fixing Pattern Table**

Sheet Width	Fixing Pattern
600mm	F A A F
900mm	F A A A F
1200mm	F A A A A F
1350mm	F A A A A A F

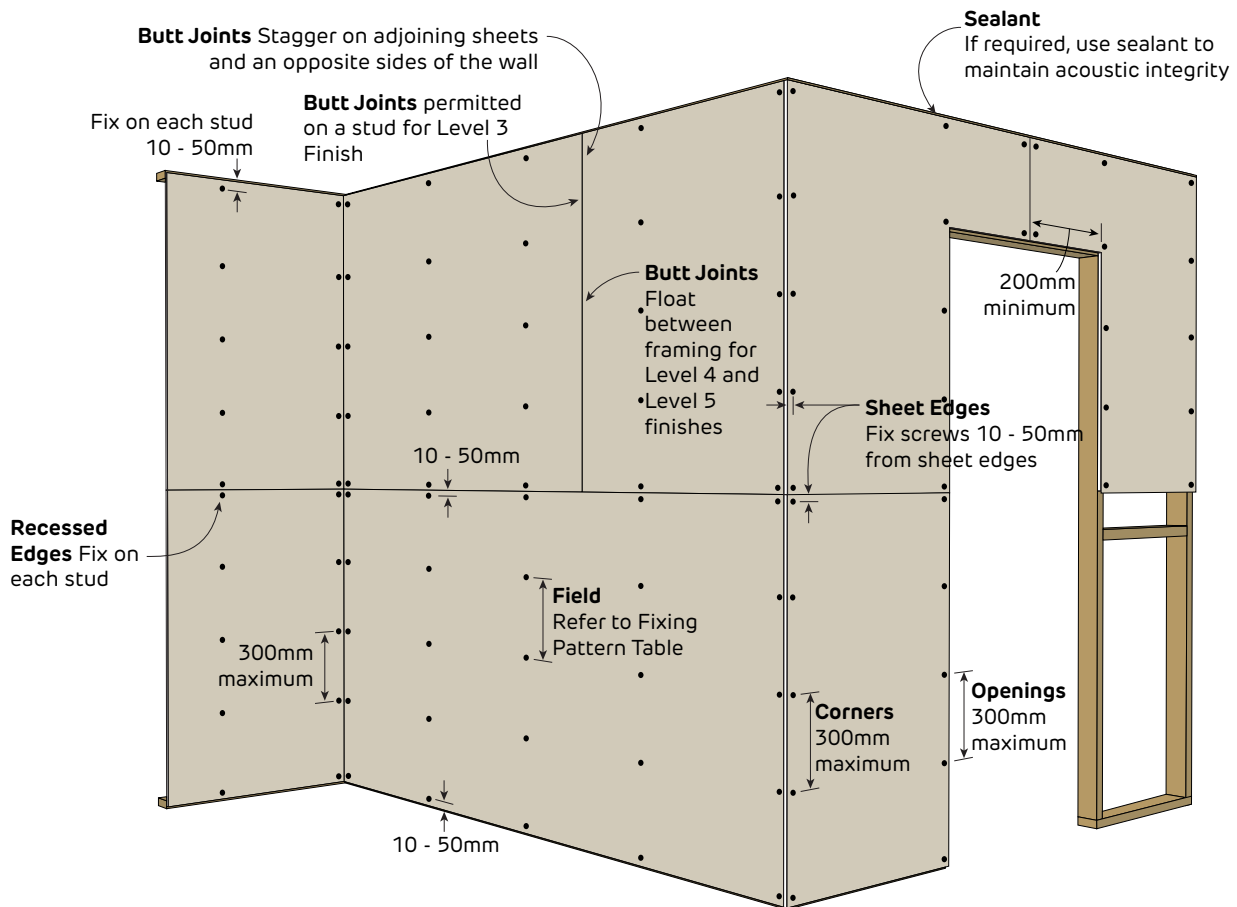
F = One screw or nail  
A = One adhesive daub

**Maximum Wind Class Table**

Plasterboard	Maximum Wall Stud Spacing		
	600mm	450mm	300mm
All 10mm and 13mm plasterboards	N5	N6 / C1	N6 / C2

1. Wind loads in accordance with AS 4055 Wind loads for housing.
2. Calculations do not include the framing which must be independently designed to suit the desired wind zone.

**FIGURE 27 Internal Wall - 1 Layer Horizontal**  
 Fastener Only Method



### Fixing Pattern Table

Sheet Width	Screw Fixing Pattern	Nail Fixing Pattern
600mm	S S S (3)	N N N N (4)
900mm	S S S S (4)	N N N N N (5)
1200mm	S S S S (4)	N N N N N N (6)
1350mm	S S S S S (5)	N N N N N N N (7)

S = One screw

N = One nail

### Maximum Wind Class Table

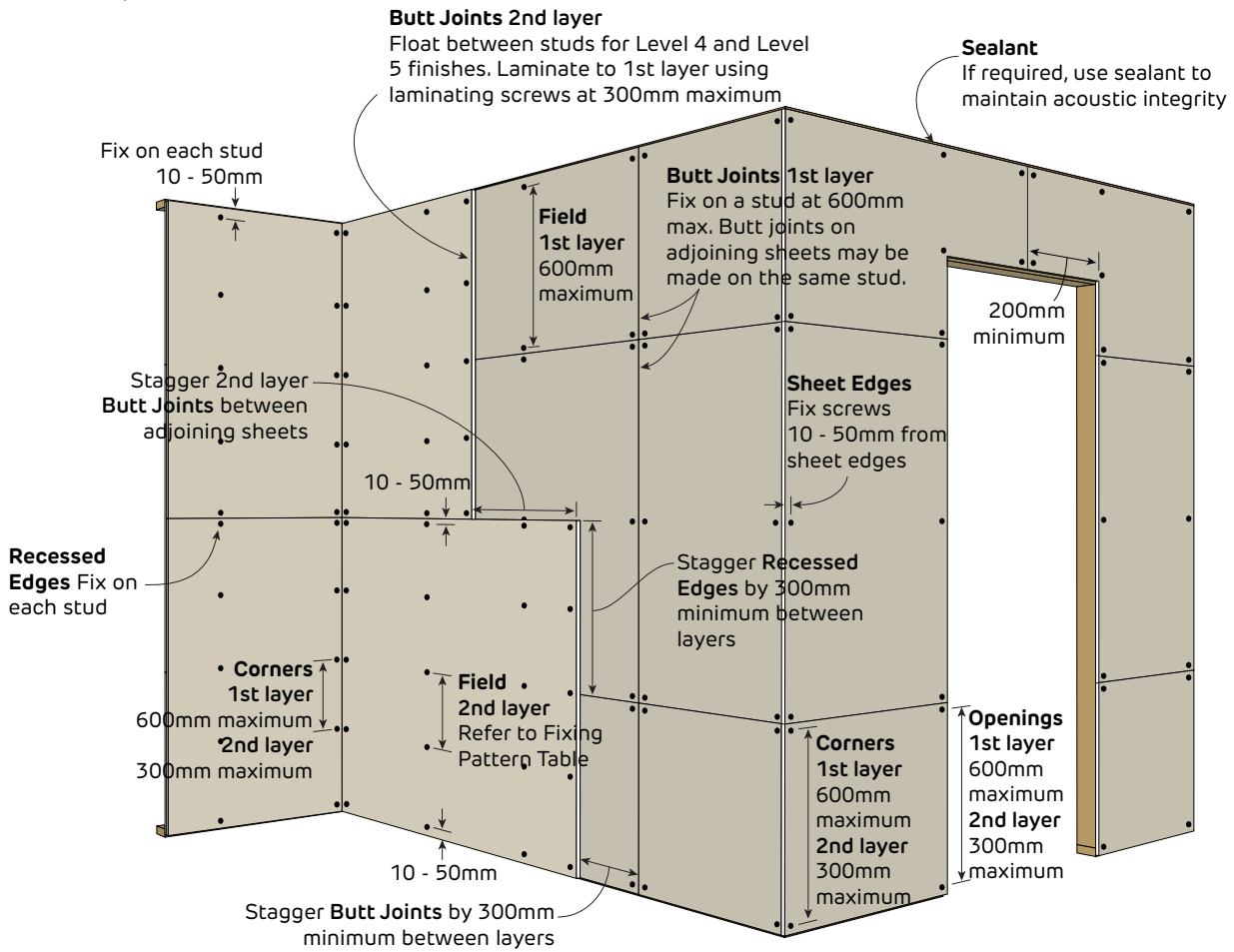
Plasterboard	Maximum Wall Stud Spacing		
	600mm	450mm	300mm
All 10mm and 13mm plasterboards	N4	N4	N5 / C1

1. Wind loads in accordance with AS 4055 *Wind loads for housing*.

2. Calculations do not include the framing which must be independently designed to suit the desired wind zone.



**FIGURE 28 Internal Wall - 2 Layers Horizontal + Horizontal**  
Fastener Only Method



**Fixing Pattern For 2nd Layer**

Sheet Width	Screw Fixing Pattern	Nail Fixing Pattern
600mm	S S S (3)	N N N N (4)
900mm	S S S S (4)	N N N N N (5)
1200mm	S S S S (4)	N N N N N N (6)
1350mm	S S S S S (5)	N N N N N N N (7)

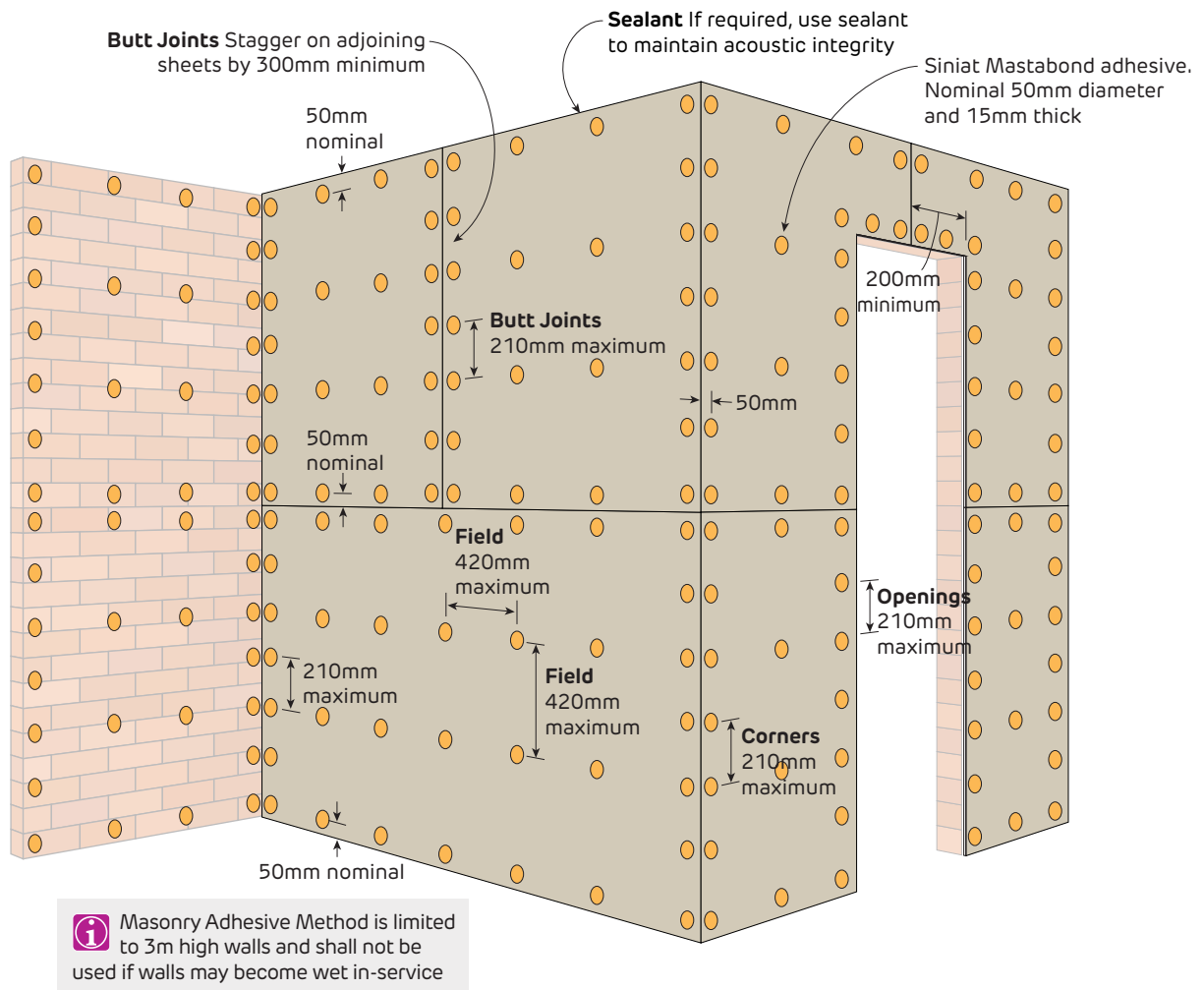
S = One screw  
N = One nail

**Maximum Wind Class Table**

Plasterboard	Maximum Wall Stud Spacing		
	600mm	450mm	300mm
All 10mm and 13mm plasterboards	N4	N4	N5 / C1

1. Wind loads in accordance with AS 4055 Wind loads for housing.
2. Calculations do not include the framing which must be independently designed to suit the desired wind zone.

**FIGURE 29 Internal Wall - 1 Layer Horizontal**  
 Masonry Adhesive Method



### Fixing Pattern Table

Sheet Width	Fixing Pattern
600mm	M M M (3)
900mm	M M M (3)
1200mm	M M M M (4)
1350mm	M M M M (4)

M = Mastabond masonry adhesive daub

### Maximum Wind Class Table

Plasterboard	Maximum Mastabond Spacing
	<b>420mm</b>
All 10mm and 13mm plasterboards	N4

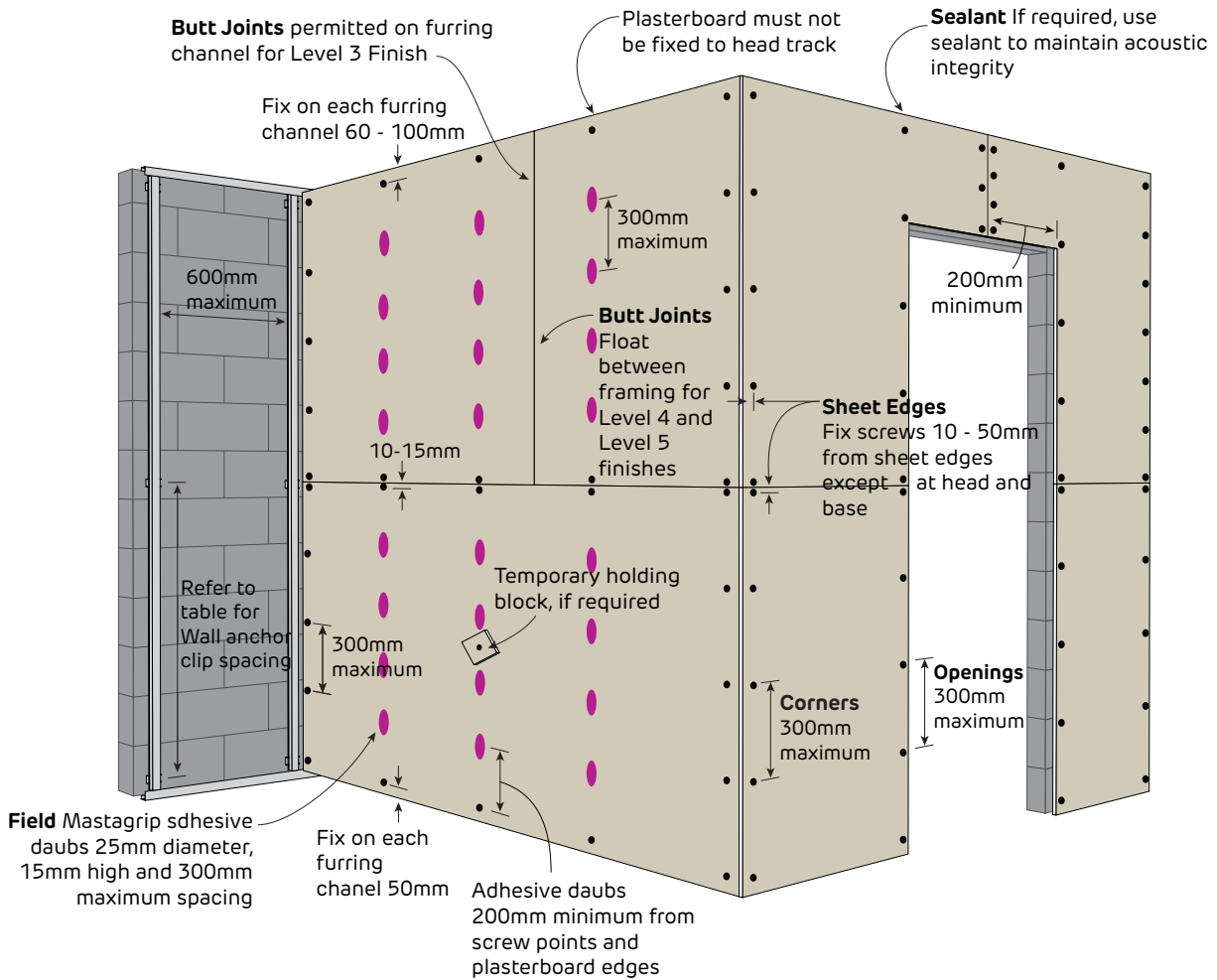
1. Wind loads in accordance with AS 4055 *Wind loads for housing*.
2. Calculations do not include the framing which must be independently designed to suit the desired wind zone.

**i** Do not use the Masonry Adhesive method for:

- > Masonry with a glazed surface finish
- > Fire rated systems
- > Multi-layer systems
- > Walls over three metres high
- > Pre-cast concrete panels that have a release agent on the surface reducing the effectiveness of the adhesive
- > Walls where the surface deviation is above 25mm
- > Walls that may become damp during service.



**FIGURE 30 Internal Wall - 1 Layer Horizontal**  
Screw and Adhesive Method over furring channels



**Fixing Pattern Table**

Sheet Width	Fixing Pattern
600mm	S A A S
900mm	S A A A S
1200mm	S A A A A S
1350mm	S A A A A A S

S = One screw

A = One adhesive daub

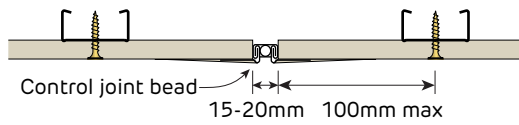
**Maximum Wind Class Table**

Plasterboard	Maximum Wall Stud Spacing		
	600mm	450mm	300mm
All 10mm and 13mm plasterboards	N5	N6 / C1	N6 / C2

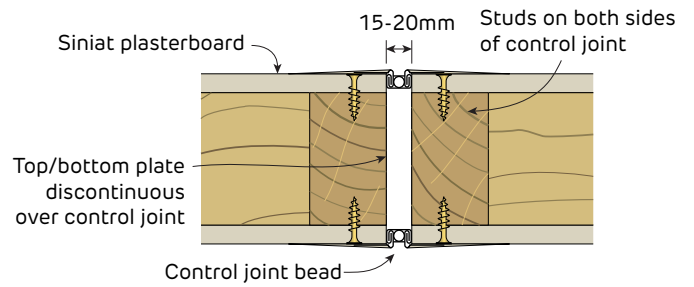
1. Wind loads in accordance with AS 4055 Wind loads for housing.

2. Calculations do not include the framing which must be independently designed to suit the desired wind zone.

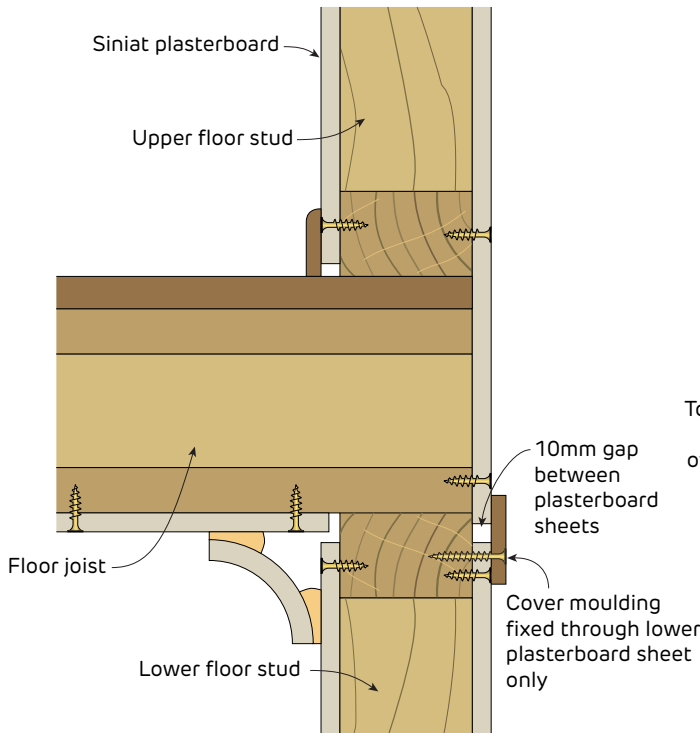
## Control Joints



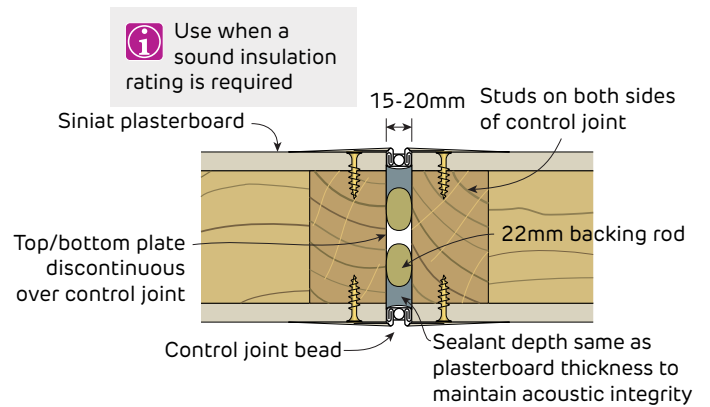
**FIGURE 31 Ceiling Control Joint**  
 Parallel to framing members - Section



**FIGURE 32 Wall Control Joint**  
 Plan

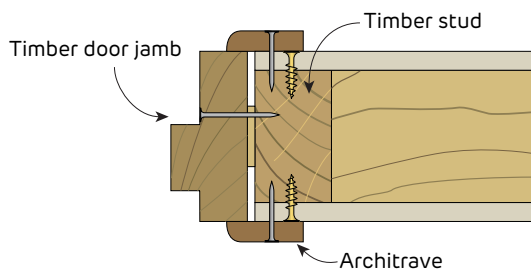


**FIGURE 33 Horizontal Control Joint at Mid-floor**  
 Section

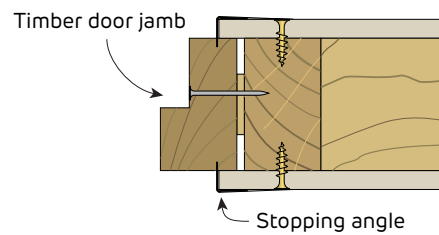


**FIGURE 34 Wall Control Joint**  
 Plan

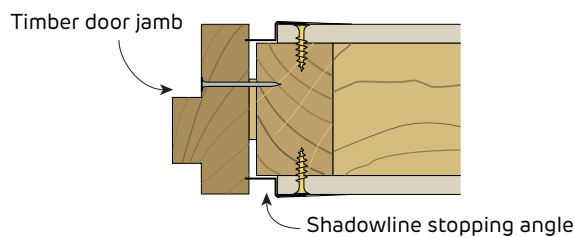
## Door Jambs



**FIGURE 35 Timber Door jamb**  
 Plan



**FIGURE 36 Timber Door jamb**  
 With Stopping Angle - Plan



**FIGURE 37 Timber Door jamb**  
 With Shadowline Stopping Angle - Plan



## 3.3 Wet Areas

### Wet Areas Using Plasterboard

*Australian Standard AS 3740:2021 – Waterproofing of domestic wet areas* defines a wet area as 'an area within a building supplied with water from a water supply system and includes bathrooms, showers, laundries and sanitary compartments.'

Waterproofing of wet areas may be achieved by using water resistant plasterboard such as **watershield**. Wet area ceilings may be non-water resistant Siniat plasterboard.

Some elements of wet area installation will be carried out by a plasterer, and other elements will be completed by trades such as plumbers and tilers. All waterproofing must be carried out by an approved applicator.

### Definitions

#### Waterproof Membrane

Waterproof membranes are a layer of material impervious to water that are usually liquid applied. They must comply with AS/NZS 4858:2004, Wet Area Membranes and be applied according to the manufacturer's instructions.

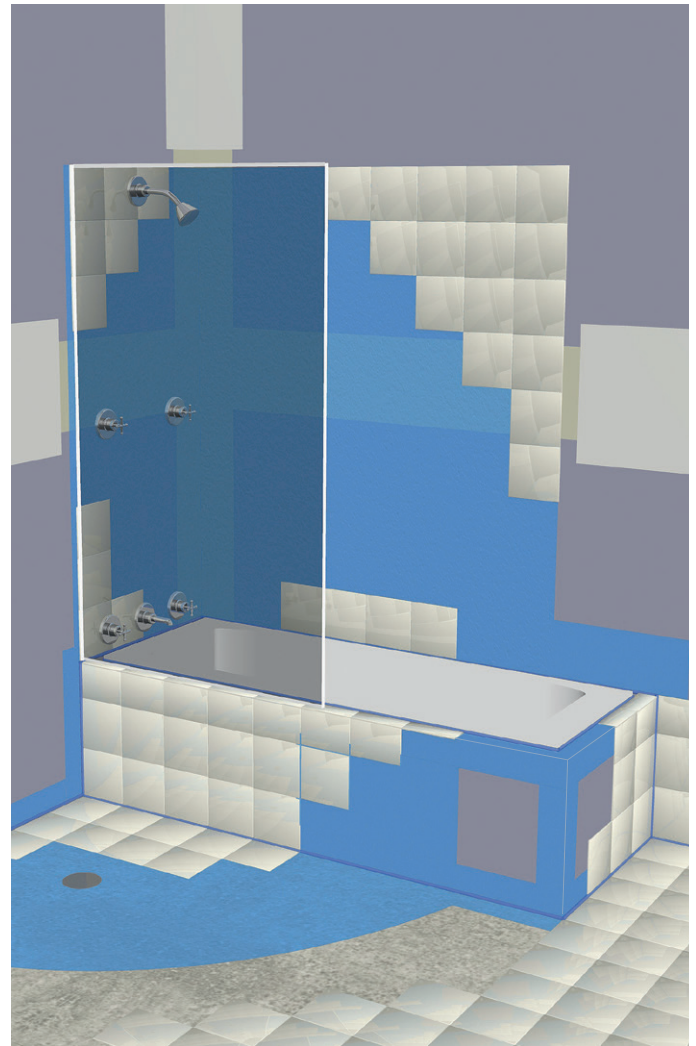
#### Flashing

Flashing is a strip or sleeve of impervious material such as a Siniat metal angle or a liquid applied product such as a waterproof membrane. It must provide a barrier to moisture movement.

#### Shower Area

Shower areas consist of enclosed and unenclosed areas:

- > Unenclosed shower areas extend 1500mm horizontally from the shower connection on the wall, up to a height of 1800mm from the finished floor
- > Enclosed shower areas are bounded by walls or screens up to a height of 1800mm from the finished floor. Walls or screens include hinged or sliding doors that control the spread of water to within the enclosure



**FIGURE 38 Bath with Shower over concrete floor**

**i** A shower fitted with a frameless glass shower screen or screen over a bath less than 1500mm long is not an enclosed shower.





## Wet Area Requirements

Different wet areas require different levels of treatment to protect them from moisture.

**Table 16 Wet Area Installation Requirements**

Area	Level of Risk	Walls	Junctions	Penetrations <sup>+</sup>
Shower area including with integrated bath	High	Waterproof	Waterproof	Waterproof
Bathrooms	Medium	-	Waterproof <sup>^</sup>	-
Areas adjacent to inserted baths and spas	Medium	Waterproof to 150mm high	Waterproof	Waterproof*
Walls adjoining other vessels such as sinks, basins and laundry tubs	Low	Water resistant to 150mm high	Waterproof	Waterproof*
Laundries and WC's <sup>^</sup>	Low	-	Water resistant with waterproof sealant	Waterproof
Bathrooms and laundries requiring a floor waste	High	-	Waterproof <sup>^</sup>	Waterproof

+ Including mechanical fixings or fasteners.

<sup>^</sup> WC's with handheld bidet spray require further waterproofing.

\* Horizontal surface waterproof, vertical surface water resistant.



## Waterproofing Systems

<b>Waterproof Walls</b>
Use <b>watershield</b> , <b>multishield</b> , <b>trurock</b> or <b>trurock hd</b> covered with a waterproof membrane and tiles.
For all plasterboard joints, corners and fastener heads use <b>mastabase</b> or <b>mastalongset</b> .
[Refer to waterproof membrane manufacturer for application instructions]
<b>Water Resistant Walls</b>
Use <b>watershield</b> , <b>multishield</b> , <b>trurock</b> or <b>trurock hd</b> covered with a tiles.
For all plasterboard joints, corners and fastener heads use <b>mastabase</b> or <b>mastalongset</b> .
<b>Waterproof Penetrations</b>
Use a waterproof sealant or a proprietary flange system to waterproof penetrations.

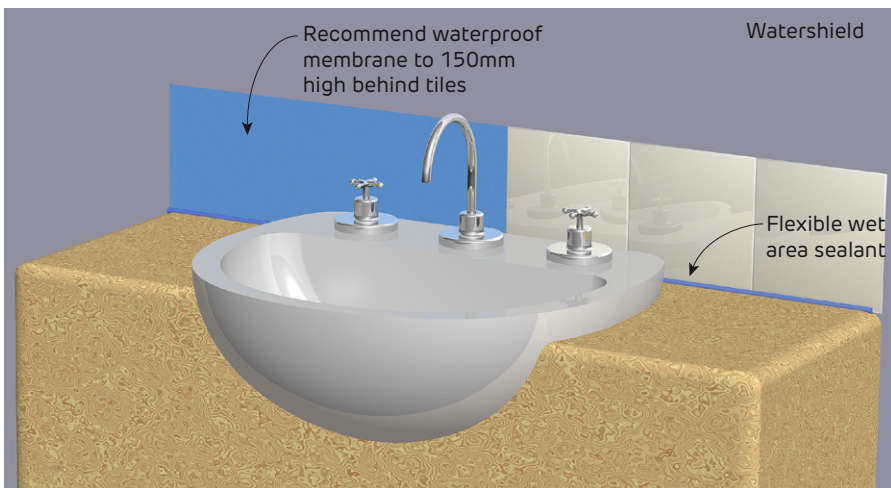


FIGURE 39 Basin

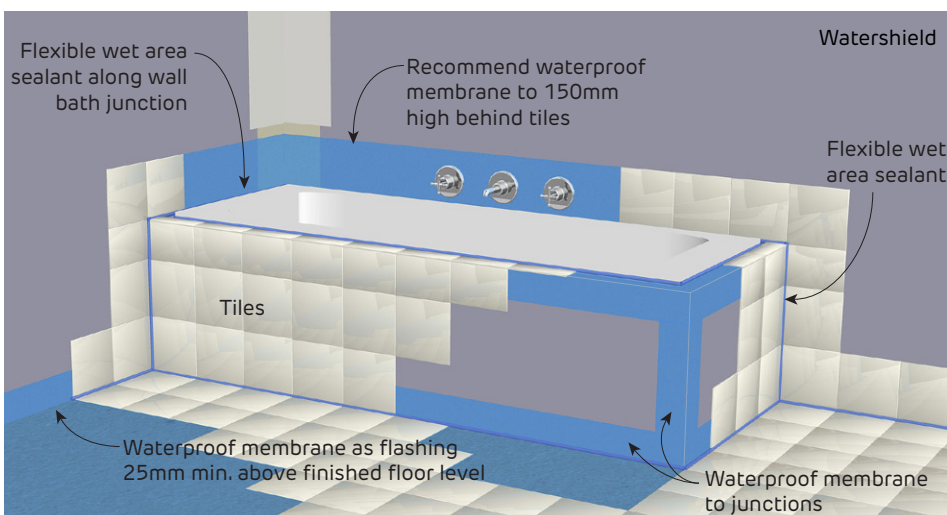


FIGURE 40 Bath (without shower) installation on timber flooring

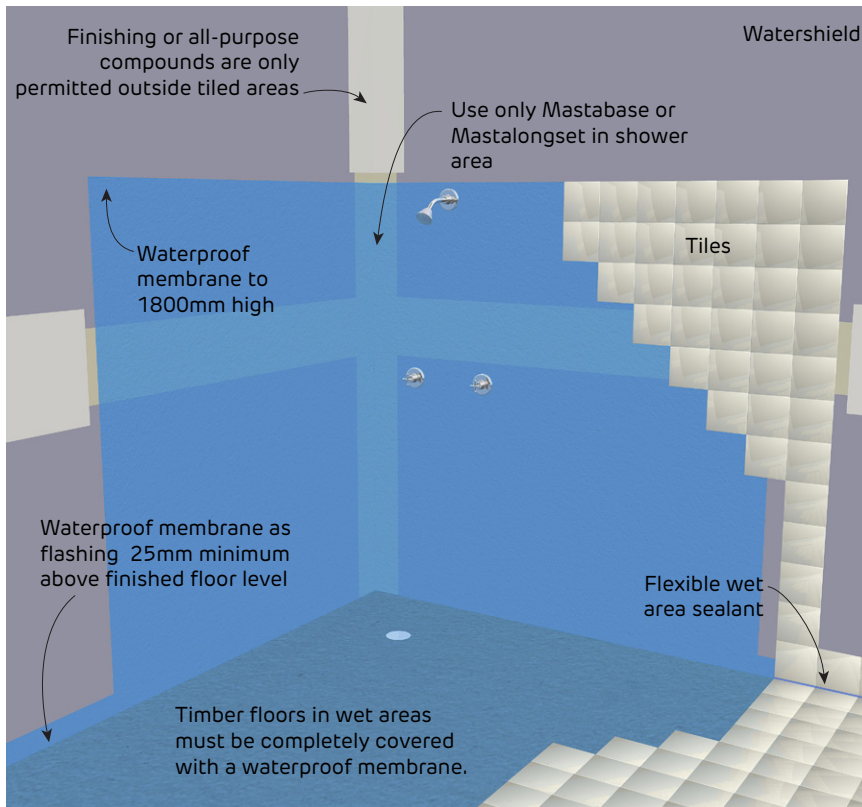


FIGURE 41 Internal in situ tray on timber flooring

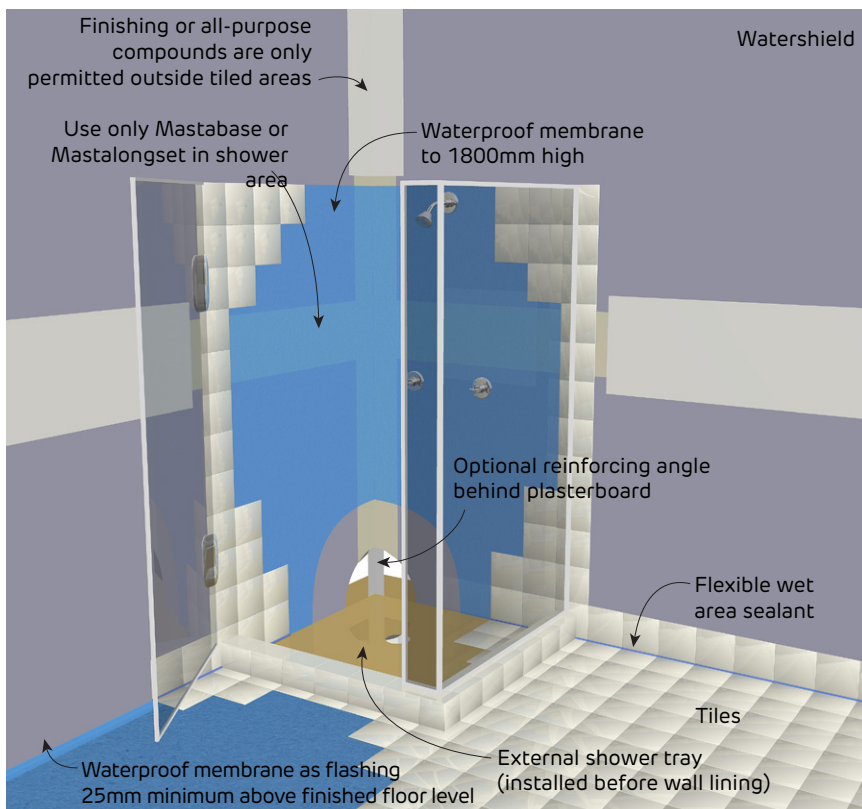


FIGURE 42 External tray for enclosed shower on timber flooring



## General Requirements

Waterproof all cut edges of <b>watershield</b> that may be affected by moisture, including all penetrations and the bottom edge over a preformed shower base.
Only use paper tape and <b>mastabase</b> or <b>mastalongset</b> for jointing in tiled areas to strengthen the joint and provide a continuous surface for the waterproof membrane.
Recess pre-formed shower bases, baths and spas sufficiently into the wall to allow the tiles to pass down the inside perimeter rebate of the shower base.
After the installation of tiles, apply a waterproof sealant to all wall/floor junctions and vertical corner joints.



- > Stud adhesive is not permitted in tiled areas.
- > Frame movement should be limited at junctions in high risk areas such as showers. For this purpose recommend using a minimum 35x35mm x 0.7mm BMT steel backing angle fixed to the frame in internal corners.

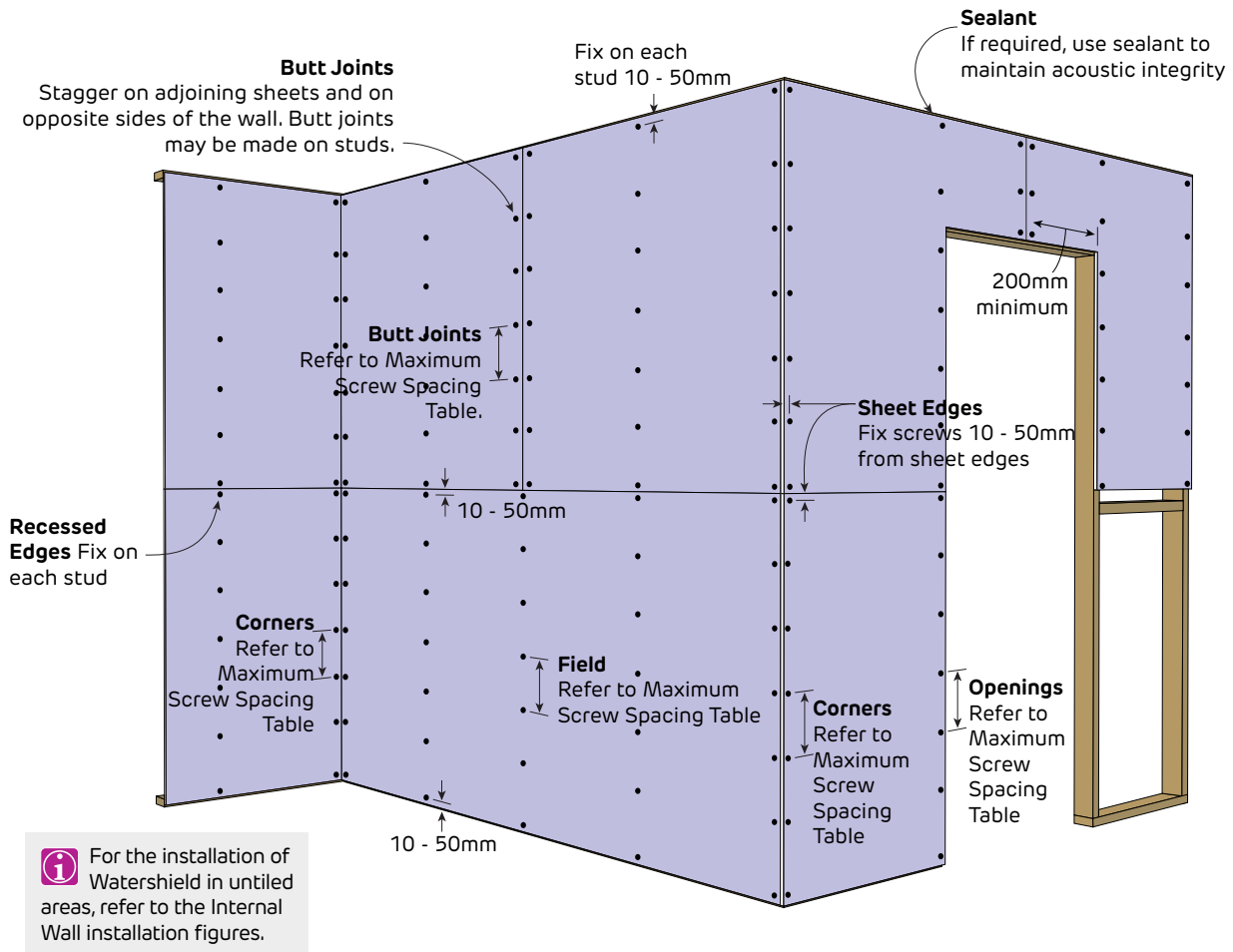
## Framing

For maximum stud spacing, refer to installation diagrams.
For masonry walls lined with moisture resistant plasterboard and tiles, use the furring channel method (except WA).

## Plasterboard Fixing

Use the 'Screw Only Method' in tiled areas. Stud adhesives are not permitted (except WA).
Drive fasteners to just below the sheet surface, taking care not to break the paper linerboard. For over-driven screws, install another screw 20mm away. Leave or remove the over-driven screw and patch.
Laminating screws can be used to fix butt joints in the second and third layer.
Tiles weighing up to 22 kg/m <sup>2</sup> (porcelain 9mm thick) may be installed when fasteners are spaced at 200mm maximum centres.
Tiles weighing from 22 to 32 kg/m <sup>2</sup> may be installed when fasteners are spaced at 200mm maximum centres on studs at 450mm centres, or fasteners spaced at 100mm centres on studs at 600mm maximum centres.

**FIGURE 43 Watershield in Tiled Areas - 1 Layer Horizontal**  
Screw Only Method



**Maximum Screw Spacing Table For Wet Area Walls (mm)**

Tile Weight	Internal Wall Stud Spacing			
	600mm	450mm	400mm	300mm
Up to 22 kg/m <sup>2</sup> (9mm porcelain)	200	200	200	200
Up to 32 kg/m <sup>2</sup> (13mm porcelain)	100	200	200	200

**Fixing Pattern Table**

Sheet Width	Fixing Pattern for Screws at 200mm maximum	Fixing Pattern for Screws at 100mm maximum
600mm	S S S S (4)	S S S S S S S (7)
900mm	S S S S S S (6)	S S S S S S S S S S (10)
1200mm	S S S S S S S (7)	S S S S S S S S S S S S (13)
1350mm	S S S S S S S S (8)	S S S S S S S S S S S S S S (14)
1400mm	S S S S S S S S (8)	S S S S S S S S S S S S S S S S (15)

S = Screw

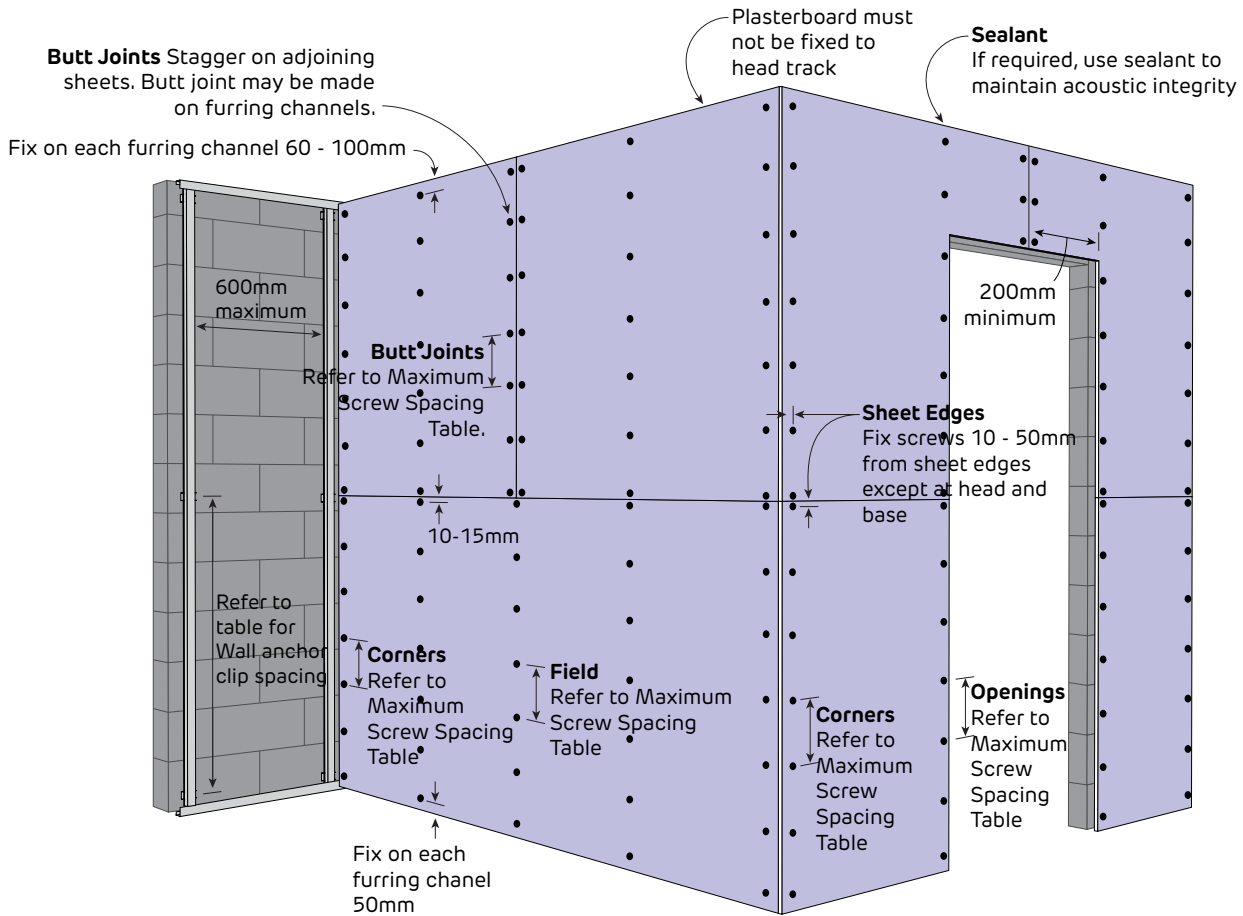
**Maximum Wind Class Table**

Plasterboard	Maximum Wall Stud Spacing		
	600mm	450mm	300mm
10mm and 13mm <b>watershield</b>	N5 / C1	N6 / C2	N6 / C3

1. Wind loads in accordance with AS 4055 *Wind loads for housing*.
2. Calculations do not include the framing which must be independently designed to suit the desired wind zone.



**FIGURE 44 Watershield in Tiled Areas - 1 Layer Horizontal**  
Screw Only Method over furring channels



**Maximum Screw Spacing Table For Wet Area Walls (mm)**

Tile Weight	Internal Wall Stud Spacing			
	600mm	450mm	400mm	300mm
Up to 22 kg/m <sup>2</sup> (9mm porcelain)	200	200	200	200
Up to 32 kg/m <sup>2</sup> (13mm porcelain)	100	200	200	200

**Fixing Pattern Table**

Sheet Width	Fixing Pattern for Screws at 200mm maximum	Fixing Pattern for Screws at 100mm maximum
600mm	S S S S (4)	S S S S S S S (7)
900mm	S S S S S S (6)	S S S S S S S S S S (10)
1200mm	S S S S S S S (7)	S S S S S S S S S S S S S (13)
1350mm	S S S S S S S S (8)	S S S S S S S S S S S S S S (14)
1400mm	S S S S S S S S (8)	S S S S S S S S S S S S S S S (15)

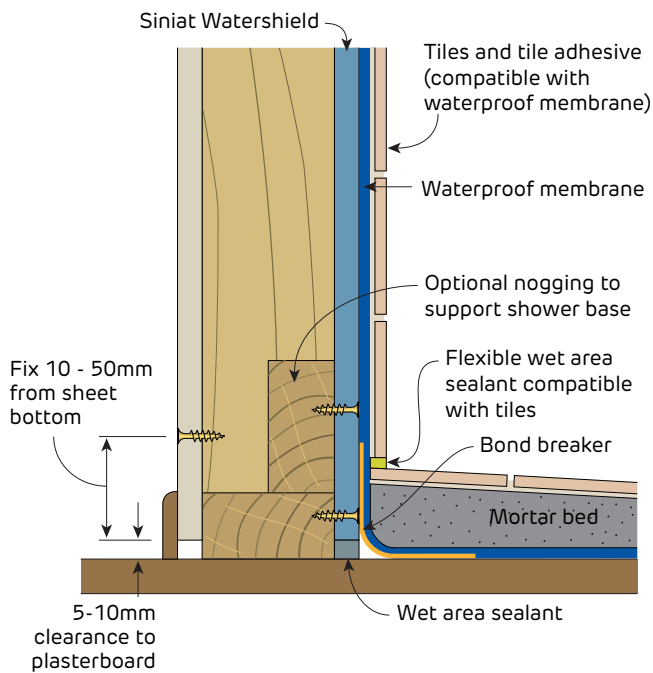
S = Screw

**Maximum Wind Class Table**

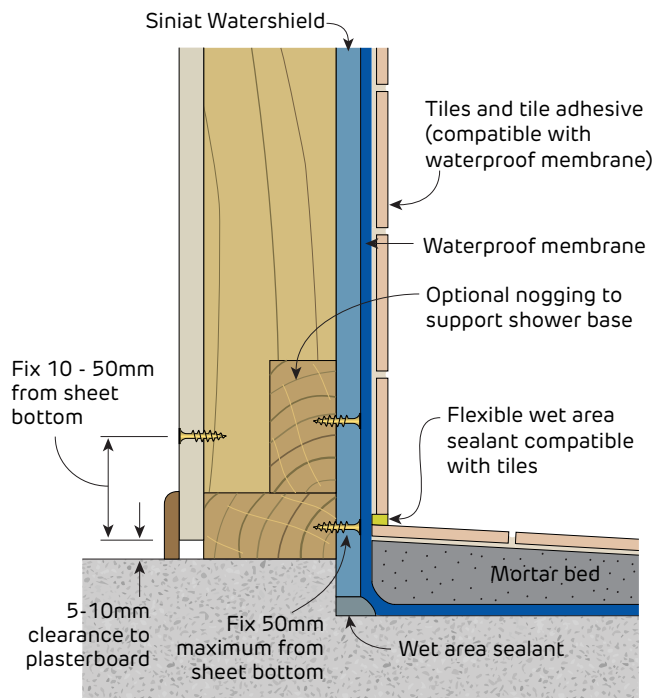
Plasterboard	Maximum Wall Stud Spacing		
	600mm	450mm	300mm
10mm and 13mm <b>watershield</b>	N5 / C1	N6 / C2	N6 / C3

1. Wind loads in accordance with AS 4055 Wind loads for housing.
2. Calculations do not include the framing which must be independently designed to suit the desired wind zone.

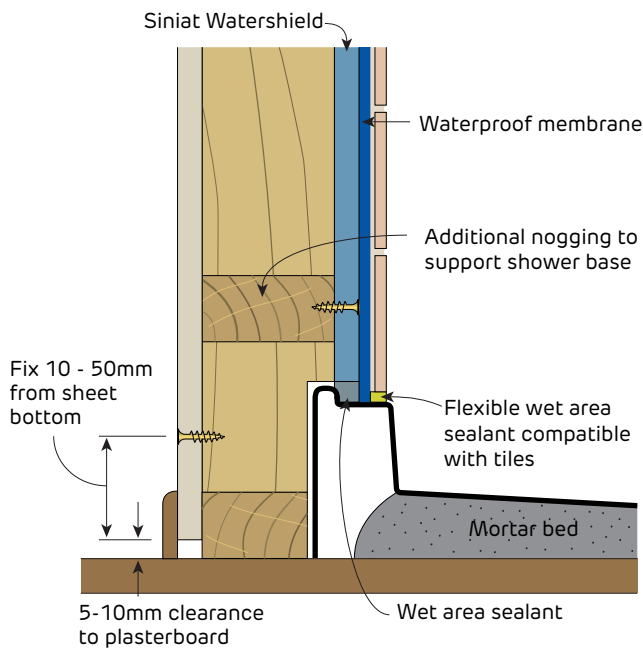
### Shower Wall Base in Wet Areas



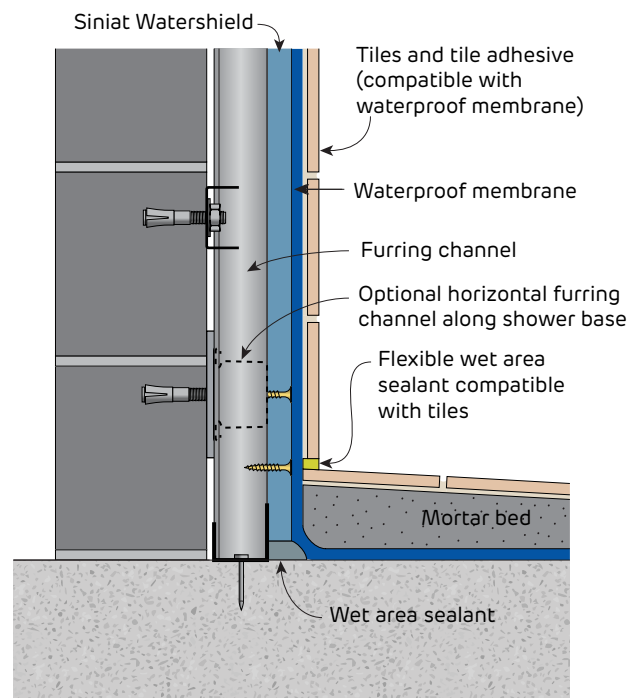
**FIGURE 45 Shower Base**  
Shower over particleboard flooring  
Class 2 membrane shown - Section



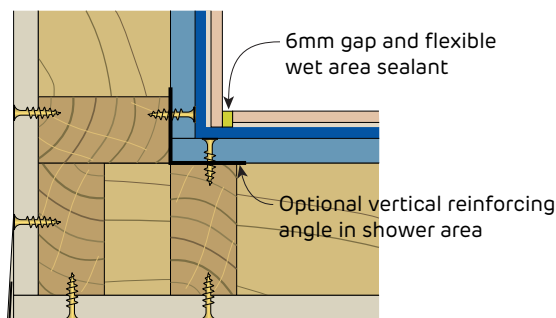
**FIGURE 46 Shower Base**  
Shower with concrete slab drop down  
Class 3 membrane shown - Section



**FIGURE 47 Shower Base**  
Pre-formed shower tray - Section



**FIGURE 48 Shower over Masonry Wall**  
Class 3 membrane shown - Section

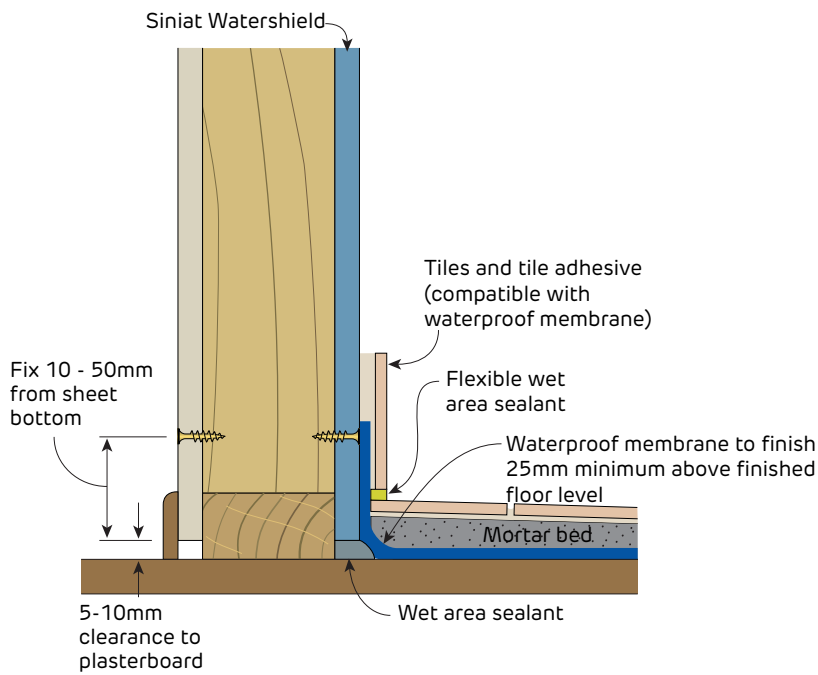


**FIGURE 49 Shower Corner**  
Plan

**i** Refer to proprietary waterproof membrane manufacturer for specific application instructions.

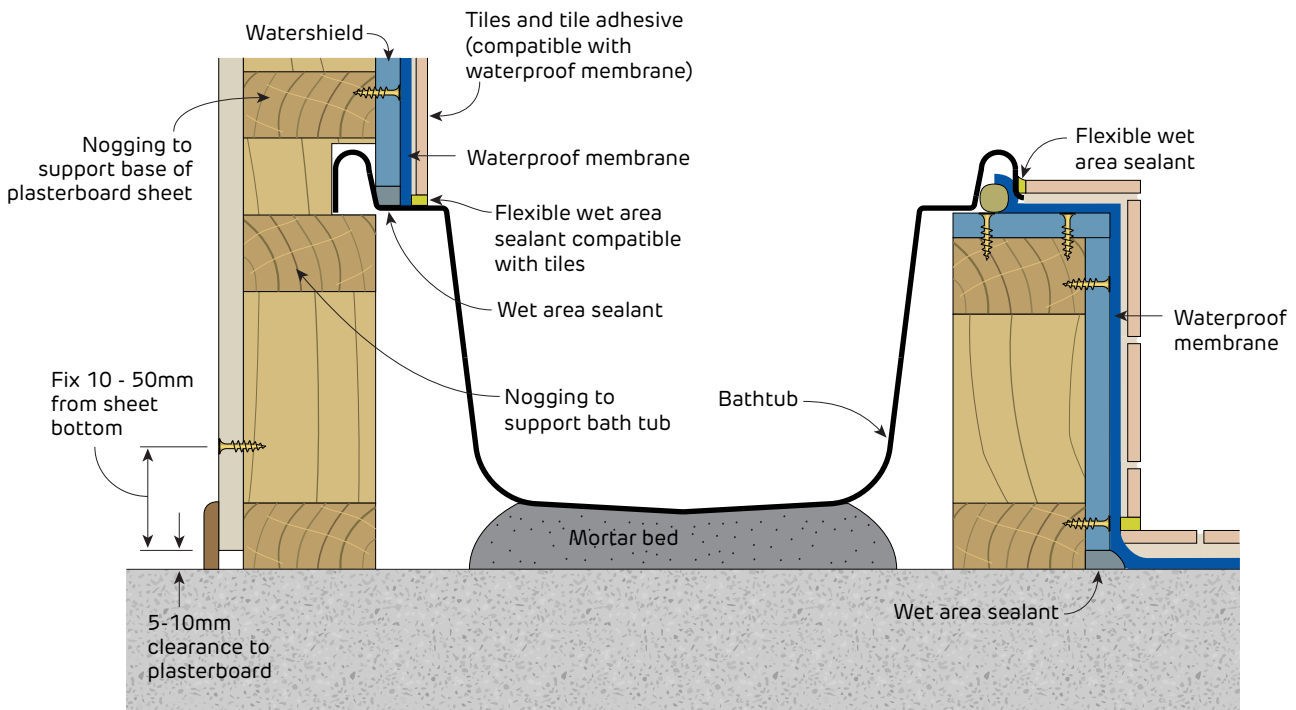


General Wet Area Detail



**FIGURE 50 Wall Base in General Wet Area**  
 Outside shower - Class 3 membrane shown  
 Section

Bath Detail

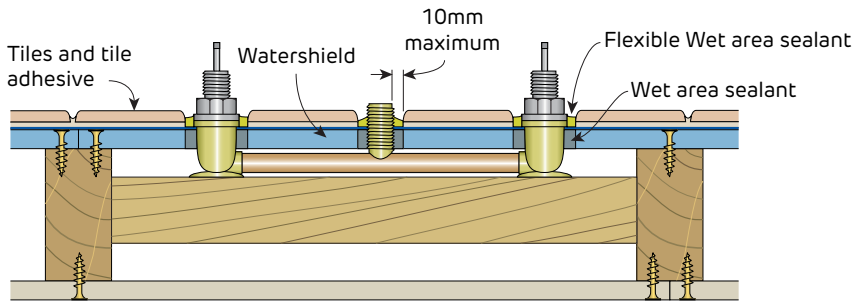


**FIGURE 51 Bathtub**  
 Section

**i** Refer to propriety waterproof membrane manufacturer for specific application instructions.

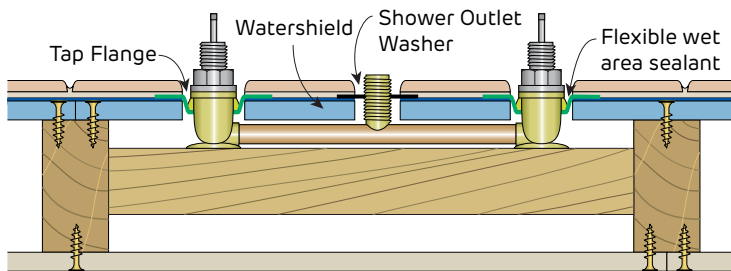


## Plumbing Penetrations



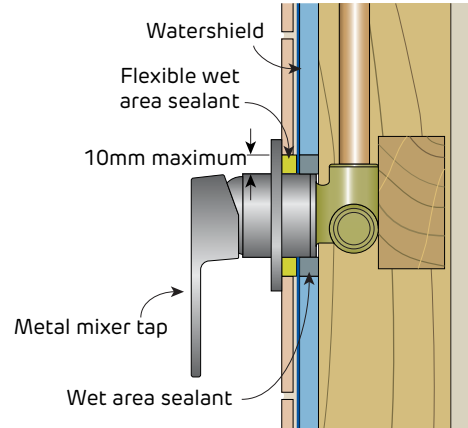
**FIGURE 52 Plumbing Penetrations**

Plan



**FIGURE 53 Alternative Plumbing Penetrations**

Proprietary tap flange and shower outlet washer  
Plan



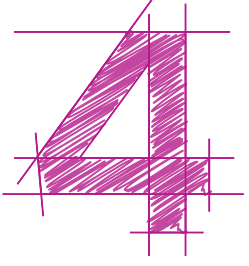
**FIGURE 54 Plumbing Penetration**

Mixer Tap  
Section

**1** Isolate copper and brass fitting from steel framing



Blank Page



# Finishing Plasterboard





<b>4.1 LEVELS OF FINISH</b>	<b>68</b>
AUSTRALIAN STANDARD REQUIREMENTS	68
LEVEL 3 FINISH	69
LEVEL 4 FINISH	69
LEVEL 5 FINISH	69
<b>4.2 BACK-BLOCKING</b>	<b>70</b>
BACK-BLOCKING CEILING RECESSED JOINTS	70
BACK-BLOCKING BUTT JOINTS	71
<b>4.3 JOINTING PLASTERBOARD</b>	<b>73</b>
COMPOUNDS	73
THREE COAT JOINTING SYSTEM	74
<b>4.4 CORNICE INSTALLATION</b>	<b>77</b>
<b>4.5 PAINTING PLASTERBOARD</b>	<b>78</b>
AUSTRALIAN STANDARD REQUIREMENTS	78
SEALER UNDERCOAT APPLICATION	78
PAINT APPLICATION	78
<b>4.6 GLANCING LIGHT</b>	<b>79</b>
MINIMISING GLANCING LIGHT	79

## 4.1 Levels of Finish

Plasterboard is finished using jointing compounds, which are sanded and then painted to achieve an even appearance.

No building lining system has a surface that is perfectly flat and totally free of imperfections. By paying attention to framing, plasterboard sheet orientation, paint finishes and lighting conditions, it is possible to attain the perception of flatness.

Careful workmanship is required at each stage of construction to achieve a high quality finish. If faults are not corrected at the earliest opportunity it may be impossible to disguise them afterwards. In addition, there are some key design principles that should be followed to avoid conditions known to highlight imperfections.

### Australian Standard Requirements

The plasterboard installation standard AS 2589:2017, Gypsum linings – Application and finishing, refers to three 'Levels of Finish' (Levels 3, 4 and 5). The standard nominates Level 4 as the default finish unless otherwise specified.

Installation in accordance with Siniat instructions will achieve a Level 4 Finish.



## Framing Requirements for Each Level of Finish

Australian Standard 2589 defines allowable deviations in the flatness of the framing surface to achieve the required level of finish. Framing members must have a minimum fixing face width of 32mm for screw fixing and 35mm for nail fixing. Framing should be true, plumb and level. Before installing plasterboard, the frame must be flat enough for the required level of finish. Over a 1.8m straight edge the frame must not deviate more than the values listed in Table 17.

### Level 3 Finish

A Level 3 Finish is recommended where no decoration is required such as walls above ceilings and concealed storage areas. The requirements for a Level 3 Finish are:

- > Framing as per the requirements in Table 17
- > A bedding coat and second coat on all face layer joints and corners.

### Level 4 Finish

Level 4 is the default finish and is recommended for most applications when lighting is favourable and light colour, matt or low sheen paints are used. The requirements for a Level 4 Finish are:

- > Framing and back-blocking as per the requirements in Table 17
- > Face layer joints finished as detailed in Section 4.3 Three Coat Jointing System
- > A quality three coat paint system as detailed in Section 4.5 Painting Plasterboard.


### Level 5 Finish

A Level 5 Finish is the highest level of finish defined in the Australian Standard. Installation of the frame and plasterboard, finishing with compounds and the correct application of paint all contribute to a Level 5 Finish. Even if completed correctly, a Level 5 Finish may not result in all surface deviations being concealed, only minimised.

A Level 5 Finish is recommended where gloss, semi-gloss or dark colour paints are used, or in harsh or critical lighting conditions which are referred to as glancing light. Higher standards are required for frame flatness, jointing and back-blocking. It involves coating the entire wall or ceiling to provide an even surface texture and porosity, which helps conceal joints and fixing points. The coating may be sprayed, rolled or trowelled over the surface.

The requirements for a Level 5 Finish are:

- > Framing as per requirements in Table 17
- > Back-blocking of all ceiling joints and wall butt joints
- > Joints finished as detailed in Section 4.3 Three Coat Jointing System
- > Application of an additional coating over the entire surface to provide uniform texture and porosity
- > A quality three coat paint system as detailed in Section 4.5 Painting Plasterboard.

 For a premium Level 4 Finish use **opal**.

**Table 17 Level of Finish Requirements for Non-Fire Rated Systems**

Level of Finish Requirements	Level 3	Level 4	Level 5
Back-block recessed joints on ceilings with 3 or more recessed joints	Optional	✓ <sup>1</sup>	✓
Back-block recessed joints on ceilings with less than 3 recessed joints	Optional	Optional <sup>1</sup>	✓
Ceiling butt joints permitted on framing members	✓	X <sup>2</sup>	X <sup>2</sup>
Wall butt joints permitted on framing members	✓	X <sup>2</sup>	X <sup>2</sup>
Minimum number of coats for jointing	2	3	3 plus skim coat
Maximum frame deviation of 90% of area (mm) <sup>3</sup>	4	4	3
Maximum frame deviation of remaining area (mm) <sup>3</sup>	5	5	4

1. Back-blocking not required for recessed joints on suspended ceiling with no rigid connection at wall/ceiling junction.

2. Back-blocking is required on these joints. [For more information, Refer to Section 4.2]

3. Over a 1.8m straight edge the frame must not deviate by more than these values.



## 4.2 Back-Blocking

Back-blocking is a method for reinforcing plasterboard joints to minimise joint cracking and peaking.

Back-blocked joints use strips of plasterboard adhered to the back of the joint between the framing members. Back-blocking adhesive must be set before commencing jointing.

**Table 18 Back Blocking Requirements**

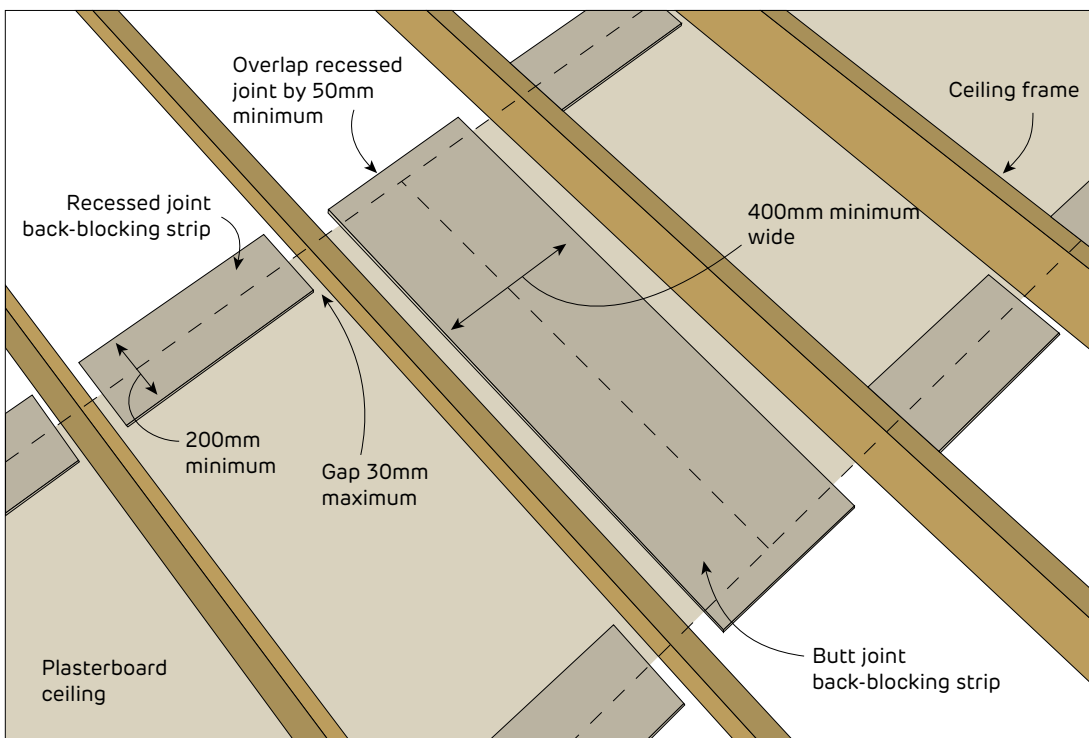
Back Blocking Requirements	
Butt joints not made on a framing member. Refer to requirements in Table 17.	✓
Ceiling joints in balconies and breezeways	✓
Joints using <b>mastaline</b> , <b>mastalite</b> , <b>mastacoat3</b> for all three coats except those made over a framing member	✓
Joints using self-adhesive fibreglass tape except those made over a framing member	✓
Joints made over a framing member	X
Multi-layer systems	X
Wall butt joints less than 400mm in length and more than 2 metres above the floor	X

## Back-Blocking Ceiling Recessed Joints

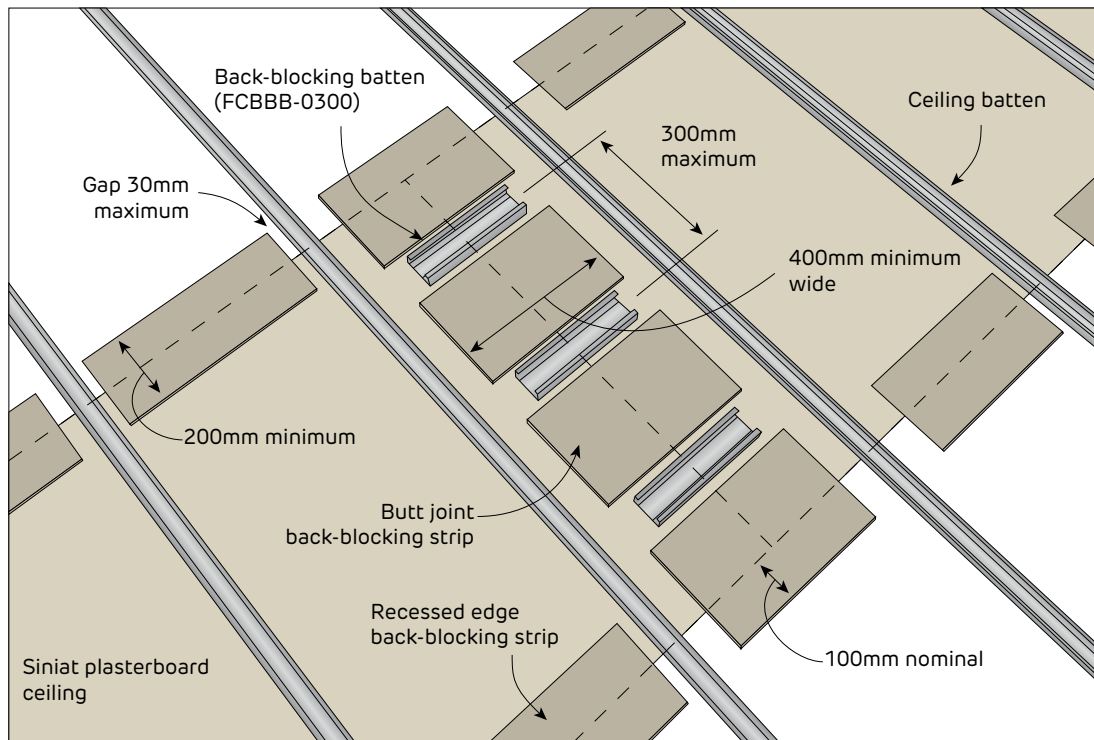
It is strongly recommended to back-block all ceiling recessed joints, not just those required by Table 17 and Table 18.

### Method

- > Ensure the back of the plasterboard is free of dust and dirt.
- > Cut back-blocking strips 200mm minimum wide and long enough to fit loosely between the framing members with a gap not greater than 30mm at each end.
- > Use a notched spreader to apply **mastablock** to the back-blocking strips to form 6mm beads at right angles to the joint.
- > Apply back-blocking strips firmly to the back of the joint.
- > Where there is no access to the back of the ceiling, fix the first ceiling sheet, apply **mastablock** to the back-blocking strip and place it midway on the board, then fix the next board.
- > Allow **mastablock** to set before commencing any jointing.



**FIGURE 55 Placement of Back-Blocking Strips For Recessed and Butt Joints**



**FIGURE 56** Placement of Back-Blocking Batten and Back-Blocking Strips for Recessed and Butt Joints

## Back-Blocking Butt Joints

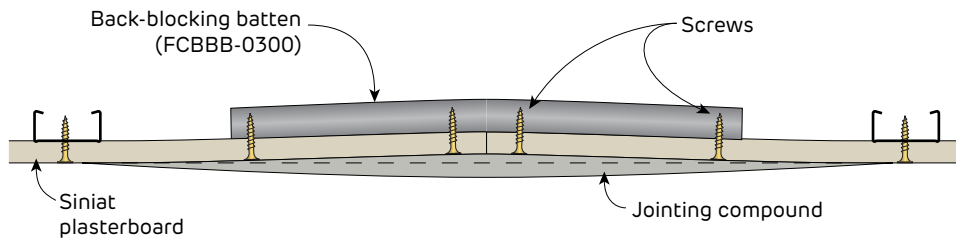
Butt joints are more difficult to conceal than recessed joints so they should be minimised. If butt joints are unavoidable, concealing them can be made easier by creating the joint mid-way between framing members, forming a recess and back-blocking.

Butt joint requirements differ for each level of finish [Refer to Table 17].

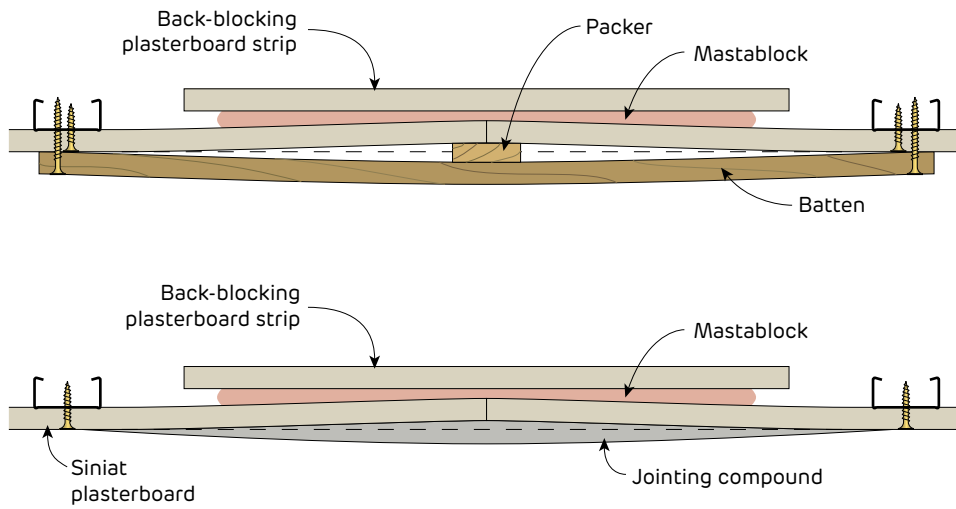
### Method

- > Create a recess by using either back-blocking battens as shown in Figure 57 or packers as shown in Figure 58 and 59.
- > Ensure the back of the plasterboard is free of dust and dirt.
- > Cut back-blocking strips 400mm minimum wide and long enough to fit loosely between the framing members. Back-blocking strips are to overlap recessed joints by 50mm minimum.
- > Wall butt joints need support for the back-blocking strips as shown in Figure 59.

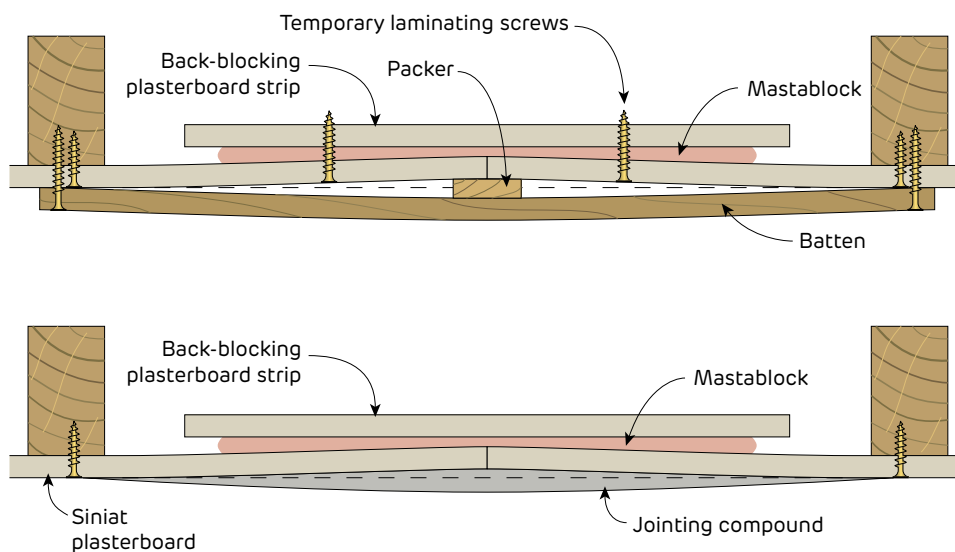
- > Use a notched spreader to apply **mastablock** to the back-blocking strips to form 6mm beads at right angles to the joint.
- > Apply back-blocking strips firmly to the back of the joint.
- > Where there is no access to the back of the ceiling, fix the first ceiling sheet. Apply **mastablock** to the back-blocking strip and place it midway on the board, then fix the next board.
- > Allow **mastablock** to set before commencing any jointing.
- > Where possible, avoid wall butt joints over single doors and cavity sliding doors to minimise joint cracking from vibration.



**FIGURE 57** Creating a Recess on a Ceiling Butt Joint using Back-Blocking Battens  
Section



**FIGURE 58** Creating a Recess on a Ceiling Butt Joint using a Temporary Packer  
Sections



**FIGURE 59** Creating a Recess on a Wall Butt Joint using a Temporary Packer  
Section



# 4.3 Jointing Plasterboard

Plasterboard walls and ceilings are jointed using compounds and reinforced with Siniat **paper tape** or corner beads.

All joints, internal and external corners and fastener heads must be evenly finished with compounds and lightly sanded to remove tool marks and ridges prior to decoration.

## Compounds

Use Siniat compounds and **paper tape** with Siniat plasterboard systems. Performance of all systems in this guide rely on using nominated Siniat compounds and **paper tape**. Use of non-Siniat compounds and **paper tape** may reduce a system's fire rating, adhesion, appearance or other aspects of performance.

To achieve the FRL, fire rated systems require as a minimum, **paper tape** and two coats of **mastabase/ mastalongset** or three coats of any Siniat all purpose air-drying compound. Alternatively use **bindex fire and acoustic sealant** as permitted and detailed in the Bindex Product Data Sheet.

Joints in wet areas must use paper tape. Areas to be tiled must only use **mastabase** or **mastalongset**. Multi-layer systems only require face layer joints to be set, except GIB X-Block systems where all layers must be set.

There are two types of products used for jointing plasterboard: chemical setting compounds and air-drying compounds.

## Chemical Setting Compounds

Chemical setting compounds are plaster based, supplied in powder form and when combined with water harden by chemical reaction. They create the strongest joint. Chemical setting compounds can be completely set but still damp. In cold and humid conditions, additional coats of chemical setting compounds can be applied to the joints when the compound is hard but before it is completely dry.

Hot and dry conditions may dry out a setting compound before it sets resulting in reduced strength and tape adhesion issues. Accelerating and retarding additives must not be used as they can also reduce strength. Chemical setting compounds must not be applied over air-drying compounds.

## Air-Drying Compounds

Air-drying compounds are premixed and harden by drying out.

Previous coats of air-drying compound or chemical setting compounds must be completely dry before applying the next coat and before sanding.

In cold and humid conditions air-drying compounds may take longer to dry. Ventilation such as open windows or an exhaust fan may be required. Air-drying compounds must not be used in temperatures lower than 10°C.

**Table 19 Type and Use of Finishing Compounds**

Compound	Type	Application			Wet Areas Under Tiles	Fire Rated Systems
		Bedding	Second	Finish		
<b>Bedding Cements</b>						
<b>mastabase</b>	Chemical setting powder	✓	✓	✗	✓	✓
<b>mastalongset</b>	Chemical setting powder	✓	✓	✗	✓	✓
<b>Finishing Compounds</b>						
<b>mastaglide</b>	Air-drying premixed	✗	✗	✓	✗	✓
<b>All Purpose Compounds</b>						
<b>mastalite</b>	Air-drying premixed	✓	✓	✓	✗	✓
<b>mastaline</b>	Air-drying premixed	✓	✓	✓	✗	✓
<b>box ready mastaline</b>	Air-drying premixed	✓	✓	✓	✗	✓
<b>mastatape-in</b>	Air-drying premixed	✓	✓	✗	✗	✓
<b>mastacoat3</b>	Air-drying premixed	✓	✓	✓	✗	✓



## Three Coat Jointing System

The Three Coat Jointing System consists of a Bedding Coat, a Second Coat and a Finish Coat of compound. Level 4 Finish and Level 5 Finish must use the Three Coat Jointing System for all joints and external corners.

Internal corners only require a Bedding Coat and a Finish Coat.

### Bedding (First) Coat

#### Method

- > Fill any gaps more than 3mm at the joint and allow compound to set or dry
- > Using a broadknife, evenly fill the recess with compound [Refer to Figure 64 for minimum coat widths]
- > Place Siniat **paper tape** along the joint and bed it into the compound, removing excess compound and any air bubbles from behind the **paper tape** [Refer to Figure 60]
- > Apply a skim coat of compound over the **paper tape**.

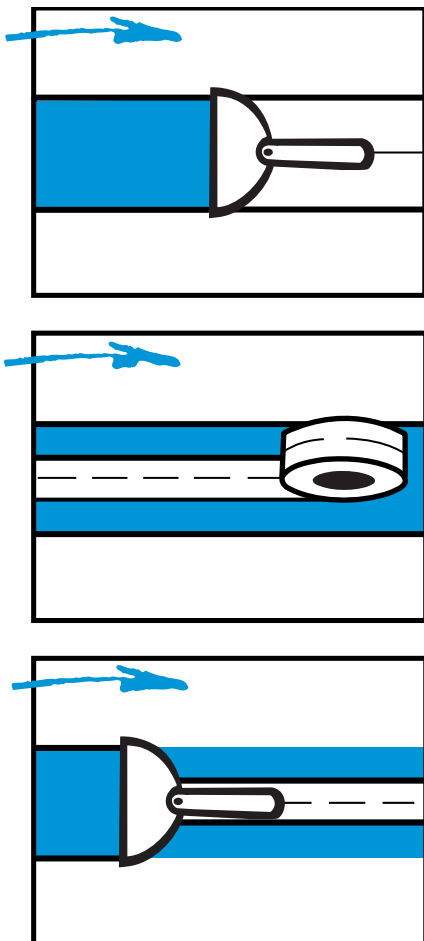


FIGURE 60 Bedding Coat

### Second Coat

#### Method

- > Allow the first coat of compound to set or dry
- > Using a 200mm trowel to apply a second coat of compound [Refer to Figure 61 and to Figure 64 for minimum coat widths]
- > Feather the joint edges to remove excess.

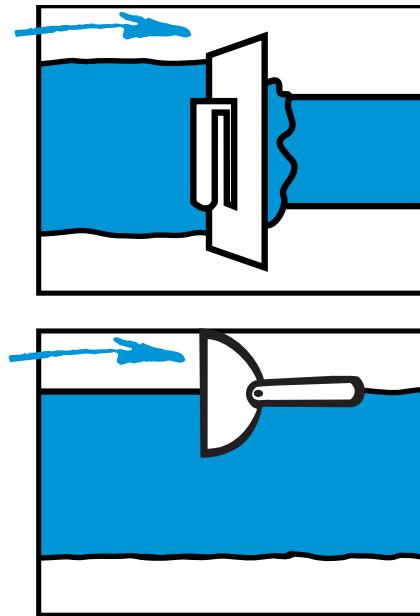


FIGURE 61 Second Coat

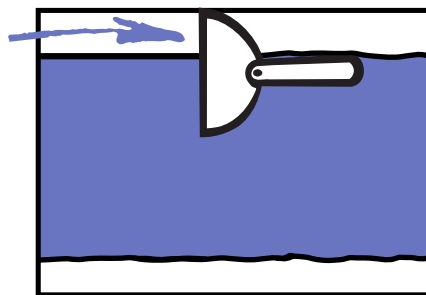
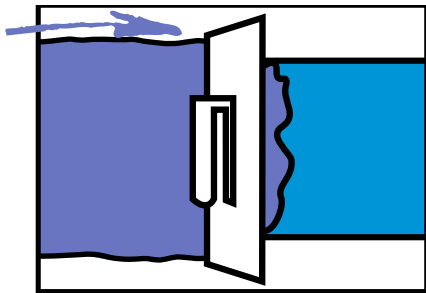
**i** > Siniat **paper tape** is strongly recommended for all joints.

- > Joints made using paper tape are stronger and less prone to defects than those made with fibreglass tape. For the strongest joint, paper tape is recommended with two coats of **mastabase**, **mastalongset** or **mastatape-in** and a final coat of **mastaglide**, **mastalite** or **mastaline**.
- > If fibreglass tape is used, all joints must be back-blocked or backed by a framing member. Fibreglass tape is not permitted for use in wet areas or fire rated systems.
- > If an air-drying compound is used for 3 coats, then all joints must be back-blocked or backed by a framing member.

## Finishing (Third) Coat

### Method

- > Allow the second coat to set and dry, then lightly scrape off any lumps and high spots of compound
- > Use a 280mm trowel to apply a third coat of compound [Refer to Figure 62 and to Figure 64 for minimum coat widths]
- > Feather the joint edges to a smooth even surface, removing any excess
- > Allow the compound to fully dry before sanding.



**FIGURE 62** Finishing Coat

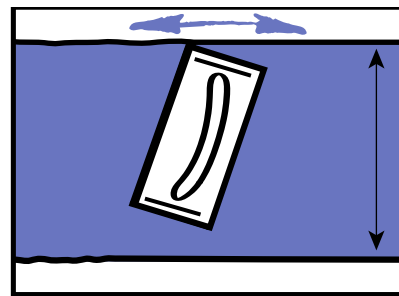
## Fasteners

- > For level 4 and 5 finishes, cover fastener heads with two coats of compound. Apply each coat in a different direction.
- > For a level 3 finish, cover with one coat of compound.
- > For fire rated systems, the setting of fasteners is not required for a level 3 finish.

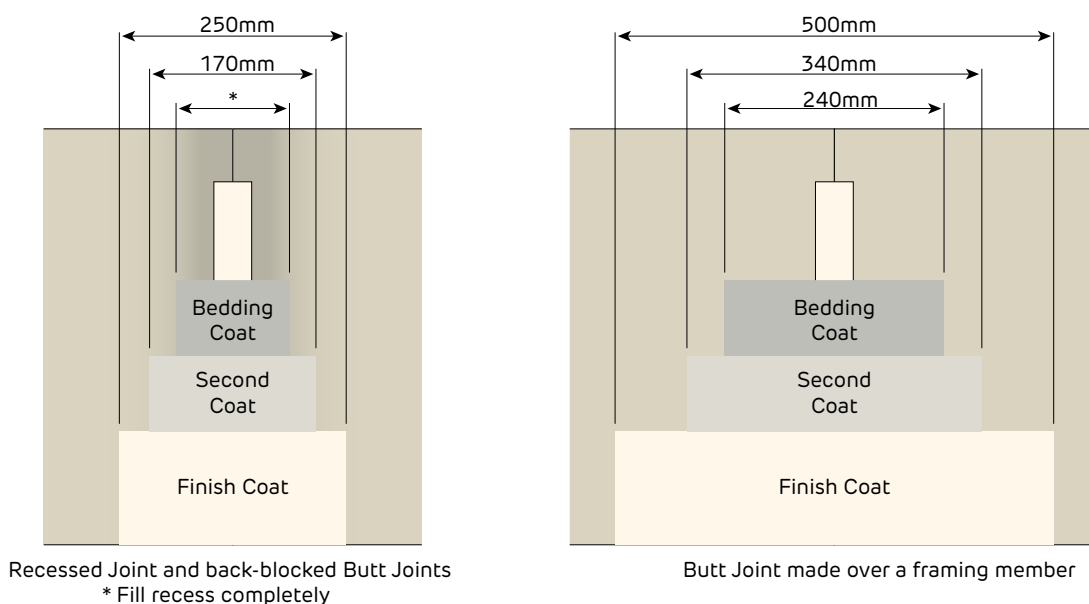
## Sanding

### Method

- > Lightly sand to a smooth even surface using 180 to 220 grit sandpaper or sanding mesh. [Figure 63]
- > Do not expose or scuff the paper linerboard while sanding
- > Use power sanders with care as they can easily over sand the joint
- > A finished joint should have a slight crown.



**FIGURE 63** Sanding



Recessed Joint and back-blocked Butt Joints  
\* Fill recess completely

Butt Joint made over a framing member

**FIGURE 64** Minimum Coat Widths After Sanding



## Internal Corners

### Method

- > Use a 75mm broadknife to apply compound to the corner
- > Fold paper tape in half and bed it into the compound using a corner taping tool
- > Cover the tape with a thin coat of bedding compound and remove any excess. Allow to set or dry
- > Apply a finish coat with a 100mm broadknife to both sides of the angle
- > Feather the edges and finish the joint with an internal angle finishing tool. Allow to dry
- > Lightly sand to a smooth finish before painting.

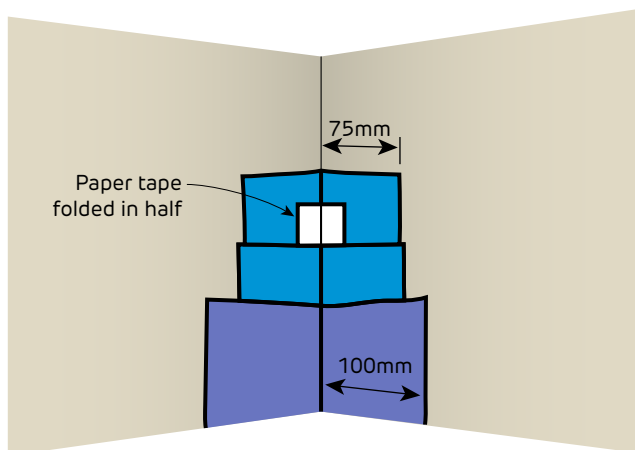


FIGURE 65 Internal Corner

## External Corners

### Method

Position the Siniat corner bead ensuring that it is plumb and straight [Refer to Figure 66]

Fix the bead in place using fasteners or staples at 300mm centres on both sides.

For PVC corner beads, follow the manufacturer's installation instructions.

Treat external corner beads with the three coat jointing system as described previously. The minimum width of the three coats on both sides of the external corner is:

- > Bedding coat 200mm
- > Second coat 230mm
- > Finish coat 250mm.

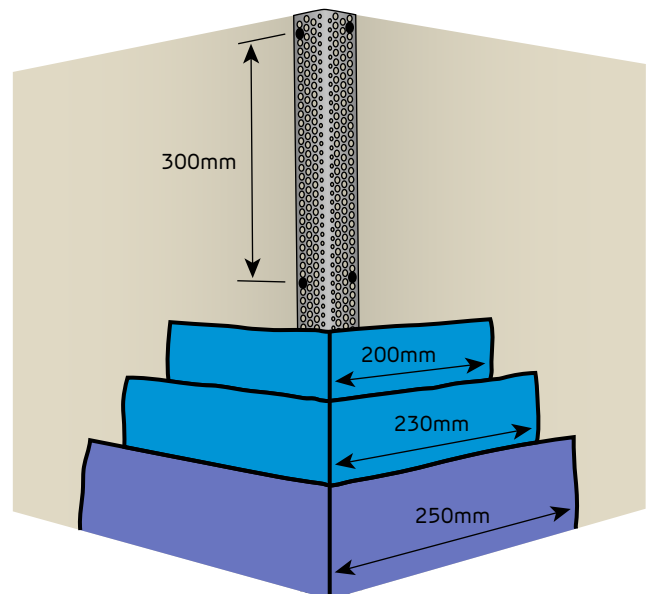


FIGURE 66 External Corner

# 4.4 Cornice Installation

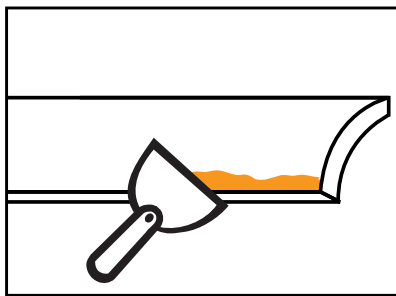
Cornice is used to complete the decoration of the building. Cornice is fixed to walls and ceilings using cornice cements, which are chemical setting compounds available in powder form.

Cornice cements are selected depending on the length and stability of the setting time, as well as their features for practical application, such as the ability to work back the cornice cement, polish mitres and the instant grab strength.

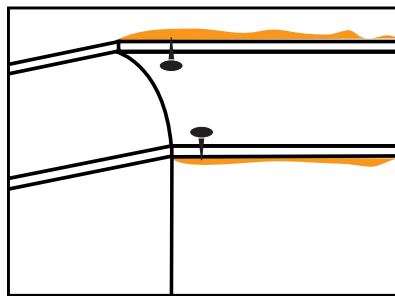
## Method

- > Ensure that wall and ceiling surfaces are free of dust and dirt
- > Measure and cut all cornices to the required lengths. Cut internal and external mitres using a mitre box

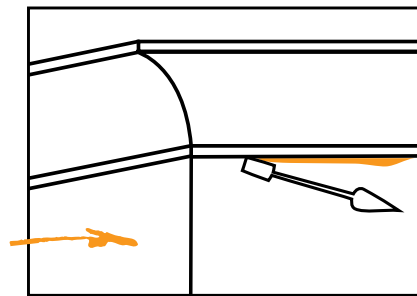
- > Avoid joints in straight runs where possible. If necessary, mitred joints are recommended
- > Measure and mark cornice projection on wall and ceiling to ensure accurate placement
- > Mix only the quantity of cornice cement that can be used within the setting time
- > Spread a 10mm continuous bead of cement along both back edges and the mitred end of the cornice [Figure 67]
- > Press the cornice into place and if necessary hold with temporary nails in the wall and ceiling along the edges of the cornice [Figure 68]
- > Clean off excess and remove nails when cement has partially set. Straight stop along cornice edge at wall and ceiling. [Figure 69]
- > Finish mitres using a small cornice tool [Figure 70]
- > Wipe down the cornice with a wet sponge [Figure 71].



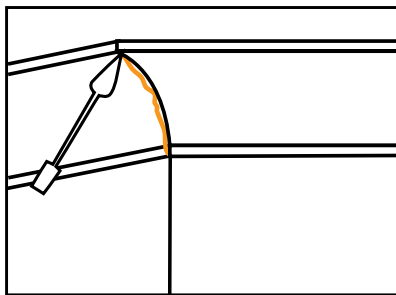
**FIGURE 67 Butter Up**



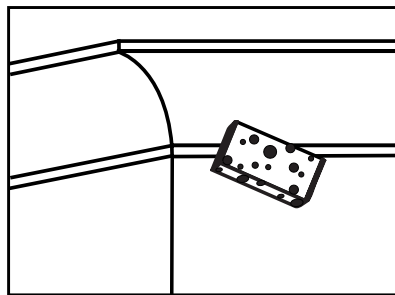
**FIGURE 68 Position Cornice**



**FIGURE 69 Clean Off Excess**



**FIGURE 70 Mitres**



**FIGURE 71 Wipe Down**

**Table 20 Type and Use of Compounds - Cornice Cements**

Compound	Type	Setting Time	Application		
			Cornicing	Patching	Jointing (1st and 2nd coat)
<b>Cornice Cements</b>					
mastacove45	Chemical setting powder	45	✓	✓	
mastacove75	Chemical setting powder	75	✓	✓	
<b>3-in-1 Specialty Compounds</b>					
mastafix20	Chemical setting powder	20	✓	✓	✓



# 4.5 Painting Plasterboard

## Australian Standard Requirements

Painting systems and methods are detailed in Australian Standard AS/NZS 2311, Guide to the painting of buildings.

If painting plasterboard, a **Three Coat Paint System** must be applied to achieve the best finish. This consists of a sealer undercoat followed by two top coats. Both the quality of the paint and how it is applied have a large effect on the finished appearance of the plasterboard.

Two coat paint systems are not nominated by AS/NZS 2311 as they often do not meet the customer's expectations by showing up joints through texture and sheen variations.

## Sealer Undercoat Application

### Recommendations

- > Ensure surfaces are set and dry
- > Lightly sand any minor surface defects and brush down surfaces to remove dust
- > Apply a sealer undercoat suitable for plasterboard, preferably with a roller. Plasterboard that has been exposed to sunlight and/or is discoloured will require a stain sealer undercoat
- > Ensure the quality sealer undercoat is rolled so all plasterboard paper fibres are flat
- > Check for any unsuitable surface imperfections and repair
- > Lightly sand with fine to medium grade paper before applying top coats

## Paint Application

### Recommendations

- > Ensure surfaces are dry
- > Lightly sand any minor surface defects and brush down surfaces to remove dust
- > Apply paint to the broad areas with an appropriate 10-14 mm nap synthetic roller. The roller nap gives a slight texture that improves the overall evenness of finish
- > Ensure each paint film is dry and manufacturer's recoat times are followed before applying the next coat.

If plasterboard is to be spray painted, the paint must not be diluted more than the manufacturer recommends. While the sealer undercoat is still wet, the surface should be back rolled to leave a 'roller finish'. This helps to equalise the surface texture between the plasterboard and the set joints. For best results also back roll 2nd and 3rd coats. Any minor paint touch-ups can then be done with a roller rather than having to re-spray.

## Inspection

The final inspection of a plasterboard wall or ceiling occurs after painting. AS/NZS 2589 and AS/NZS 2311 recommend that visual inspection of finished surfaces of plasterboard be carried out in ordinary lighting, sighting from a distance of at least 1.5 metres from the surface. If differences of appearance are not clearly discernable the finish is usually considered acceptable.

**i** To achieve a good quality painted finish, the following recommendations in addition to the three coat paint system should be followed:

- > Apply paint according to the manufacturer's recommendations
- > Avoid spraying or brushing which require advanced application techniques
- > Choose white or light colours, flats for ceilings and matt or low sheen paints for walls
- > Select a Level 5 Finish when using medium to high gloss or dark coloured paints, or in areas of glancing light in accordance with AS2589. These paints highlight any minor imperfections in the plasterboard and make the joints more visible.

For more information on glancing light, painting and other subjects affecting the appearance of plasterboard walls and ceilings, refer to:

- > [www.awci.org.au](http://www.awci.org.au) (Association of Wall and Ceiling Industries – Australia and New Zealand)
- > [www.apmf.asn.au](http://www.apmf.asn.au) (Australian Paint Manufacturers Association).

## OnBoard - Painting Plasterboard



## 4.6 Glancing Light

Glancing Light refers to natural or artificial light being cast along the face of a surface showing any minute undulation. As a result of this light being cast, a shadow is produced on the other side of the undulation. This draws attention to surface texture variations, such as plasterboard joints and patches, which under more diffused light would not be visible.

The glancing light condition can occur even when the wall or ceiling has been built according to AS/NZS 2589. Glancing light effects are directly linked to the type and placement of light sources relative to ceilings and walls.

Glancing light can highlight the following surface conditions:

- > Sheet joints
- > Surface irregularities
- > Patches
- > Variations in paint application technique.

Attention can also be drawn to minor deviations inherent in the manufacture and installation of plasterboard.

### Minimising Glancing Light

#### Interior Design

The following are recommendations to reduce the effect of glancing light:

- > Avoid full length windows in direct sunlight
- > Avoid locating windows close to perpendicular wall and ceiling surfaces during design phase
- > Diffuse light entering a room by using curtains, blinds or other window treatments
- > Introduce curtains or blinds where windows are close to wall and ceiling surfaces
- > Use low gloss, light coloured paints applied with a brush or roller.

#### Framing

Framing members should be straight and aligned.

#### Sheet Orientation


Plasterboard sheets should be fixed parallel to the light source. Also arrange the sheets to minimise the number of joints.

#### Lighting

Glancing light caused by artificial lighting can be addressed by changing the type and/or positioning of the light fittings. Natural lighting problems are normally caused by building geometry. An example is running windows right to the edge of the ceiling or wall line.

The following are recommendations for design of light fittings:

- > Use recessed downlights and fluorescent tubes with a diffuser
- > Shade batten-fixed bulbs on the ceiling and table lamps
- > Avoid designs that will create glancing light conditions where possible
- > Position downlights so that they do not shine down the surface of a wall.

 For a premium Level 4 Finish use **opal**.

#### Level 5 Finish

A Level 5 Finish is the highest level of finish possible and can assist in reducing the effect of glancing light. By covering the entire surface, the skim coat of a Level 5 Finish fills any slight impressions in the surface, and removes the difference in texture and paint absorption between plasterboard and the joints. The framer, plasterer and painter all need to cooperate and contribute to providing a Level 5 Finish. Even when applied correctly, a Level 5 Finish is no guarantee that all surface deviations will be invisible, only minimised [Refer to Section 4.1 for details on Level 5 Finish].

#### OnBoard - Glancing Light





**Etex Australia Pty Ltd**  
ABN 61 003 621 010

31 Military Road  
Matraville NSW 2036

**[siniat.com.au](http://siniat.com.au)**



**warranty**

Siniat's products are guaranteed  
by a 10 year warranty.  
For details visit [siniat.com.au](http://siniat.com.au)

customer service and  
technical advice

**AU 1300 724 505**